

bk3000 & bk5000 Ultrasound Systems



LEGAL MANUFACTURER

BK Medical Aps
Mileparken 34
DK-2730 Herlev
Denmark
Tel.:+45 4452 8100/Fax:+45 4452 8199
www.bkultrasound.com
Email: info@bkultrasound.com

The serial number label on a BK Medical product contains information about the year of manufacture.

BK Medical Customer Satisfaction

Input from our customers helps us improve our products and services. As part of our customer satisfaction program, we contact a sample of our customers a few months after they receive their orders. If you receive an email message from us asking for your feedback, we hope you will be willing to answer some questions about your experience buying and using our products. Your opinions are important to us. You are of course always welcome to contact us via your BK Medical representative or by contacting us directly.

If you have comments about the user documentation, please write to us at the email address above. We would like to hear from you.

Scanner Software

- **NOT FAULT TOLERANT.** THE SOFTWARE IS NOT FAULT TOLERANT. BK Medical HAS INDEPENDENTLY DETERMINED HOW TO USE THE SOFTWARE IN THE DEVICE, AND MS HAS RELIED UPON BK Medical TO CONDUCT SUFFICIENT TESTING TO DETERMINE THAT THE SOFTWARE IS SUITABLE FOR USE.
- **EXPORT RESTRICTIONS.** You acknowledge that Windows 8 Embedded is of US-origin. You agree to comply with all applicable international and national laws that apply to Windows 8 Embedded, including the U.S. Export Administration Regulations, as well as end-user, end-use and country destination restrictions issued by U.S. and other governments. For additional information on exporting Windows 8 Embedded, see <http://www.microsoft.com/exporting/>
- The bk3000 and bk5000 Ultrasound Systems are closed. Any modification of or installation of software to the system may compromise safety and function of the system. Any modification of or installation of software without written permission from BK Medical will immediately void any warranty supplied by BK Medical. Such changes will also void any service contract and result in charges to the customer for restoration of the original bk3000 or bk5000 Ultrasound System.

Trademarks:

DICOM[®] is the registered trademark of the National Electrical Manufacturers Association for its standards publications relating to digital communications of medical information.

FireWire[™] is a trademark of Apple Computer, Inc.

Microsoft[®] and Windows[®] are registered trademarks of Microsoft Corporation in the United States and other countries.

Pro Package is a trademark of BK Medical.

bk3000 & bk5000 = Ref. Type 2300

© 2016 BK Medical

Information in this document may be subject to change without notice.

Contents

- Chapter 1 Before You Begin 13**

- Chapter 2 The User Interface 15**
 - Working with the Monitor 15
 - Selecting a Transducer 15
 - Selecting an Examination Type 16
 - Patient Information 17
 - Document Browser 17
 - Measurements and Image Data 17
 - Workflow Tabs 17
 - Keyboard Control Panel 20

- Chapter 3 Controls on the Monitor 21**

- Chapter 4 Working with the Image 29**
 - Selecting the Imaging Plane 29
 - Freezing the Image 29
 - Partial Freeze and the Update Key 29
 - Split Screen 30
 - Simultaneous Imaging 30
 - Linked Split/Dual 31
 - Labels and Bodymarks 31
 - Labels 31
 - Bodymarks 32
 - Cine 33
 - Using Cine 33
 - Using Cine in M-Mode or Doppler Mode 34
 - Video Display 35
 - The Video Window and Picture in Picture (PiP) 35
 - Using the Video Window 35
 - Using PiP 36

- Chapter 5 Making Measurements 39**
 - Measurements and Calculations 39
 - Making a Measurement – General Procedure 39
 - B-Mode and Color Mode Measuring Tools 40
 - Doppler Mode Measuring Tools 47

- Chapter 6 Documentation 51**
 - What are Documents? 51
 - HIPAA Compliance 51
 - Saving Documents – Capturing Images and Video Clips 51
 - Capturing 2D Images 52
 - Video Clips – Capturing while Imaging 52
 - Capturing 3D Data Sets 52

Saving Reports	52
Local Patient Archiving System	53
Reviewing Documents.	53
The Document Browser	53
Viewing and Editing Video Clips.	55
Viewing Exported Documents on the System	55
Viewing Exported Documents on an External Computer	56
Exporting Data.	57
HIPAA Compliance and Exporting Data	57
Copying to a CD/DVD or USB Storage Device.	57
Archiving to a CD/DVD or Network Drive	57
Using CD/DVDs.	58
Using USB Storage Devices.	60
Using a Network Drive.	60
The Archive Window (Examination List and Patient Information)	61
Patient Information.	62
Examination List.	62
Deleting Documents or Exams from the System	64
Starting a New Examination from the Examination List	65
Pausing and Later Resuming an Examination	65
Password Protection of the Patient Archiving System	66
Hard Disk Quota.	67
Reports.	67
Creating a Report	68
Editing a Report	69
Printing a Report.	69
Saving a Report to the Local Patient Archiving System	69
Printing Documents or Images on the Monitor	69
Printing Thumbnail Images	70
Printing Images Displayed on the Monitor.	70
Using a Transducer Button.	70
Chapter 7 Imaging Modes	71
Imaging Modes	71
Adjusting the Thermal Index Limit.	71
B-Mode	72
Focus.	72
Gain	73
Auto Gain	74
Zoom.	76
Depth	76
Gray Scales.	77
Combination Modes	77
Tissue Harmonic Imaging (True Echo Harmonics – TEH)	78
Contrast Imaging	79
X-Shine	83
Activate X-Shine Imaging	84
Adding Buttons to the Screen.	85
Color Mode and Power Mode	86

Color Submodes	86
Color Coding of Flow	86
Independent D-Mode/C-Mode Steering	87
Color Box	87
Color Scales	87
Elastography	88
Color Box	89
Color Map	90
Quality Indicator	90
Strain Ratio Measurement	90
Diameter Comparison Measurement	91
Vector Flow Imaging (VFI)	92
Using VFI	94
Arrow Flow Indicators for VFI	95
Streamlined VFI Workflow	96
Assisted Doppler Gate Placement	96
Angle Correction	97
Assisted Doppler Steering	97
Inverting the Doppler Spectrum	97
Selecting the Appropriate Scale/PRF	97
Assisted Volume Flow Rate Estimation	98
Asymmetric Doppler Gate Cross	98
Outline of VFI Workflow	99
Doppler Mode – Spectral Doppler	99
Turning Doppler Mode On or Off	99
Adjusting the Doppler Mode Image	101
Doppler Indicator	101
Independent D-Mode/C-Mode Steering	101
Doppler Trace (Automatic Curve Tracing)	101
Sweep Speed	101
M-Mode	102
The M-Mode Image	102
M-Mode Line	103
M-Mode Image Ruler	103
Saving a Preset	103

Chapter 8 Continuous Wave Doppler Mode 105

Overview	105
Adjusting the Thermal Index Limit	105
Adjusting MI	105
Turning CW Doppler Mode On or Off	105
CW Doppler Line	106
Audio Volume	107
Adjusting the Doppler Mode Image	107
Doppler Trace (Automatic Curve Tracing)	107
Auto	107
Gain	107
Scale	108
Smooth	108

Wall Filter.....	108
Invert.....	108
Baseline.....	109
Sweep Speed.....	109

Chapter 9 Pro Packages 111

Before You Begin.....	111
If You Perform a Puncture Procedure.....	111
What Is a Pro Package?.....	111
Presets.....	112
Measurements.....	112
Doppler Measurements.....	113
Stenosis.....	114
VF (Volume Flow).....	115
TAM (Time Average Mean) and TAMX (Time Average Max).....	115
RI and PI (Resistance Index and Pulsatility Index).....	116
Real-Time Measurements.....	117
Noise Limit.....	118
Carotid Velocities.....	118
Calculations.....	119
Using the Brachy Pro Package.....	119
Patient Setup.....	120
Calculating Volumes.....	120
Performing a Biopsy or Puncture Procedure (including Brachytherapy).....	122
Using the OB, Gyn, and Gyn Follicles Pro Packages.....	124
Gestational Age and Expected Date of Confinement.....	124
Patient Setup.....	124
Making Measurements.....	124
Calculation Methods.....	125
Obstetrics Reports.....	125

Chapter 10 Vascular Pro Package 129

Contents.....	129
Presets.....	129
Setting up the Patient – Patient ID.....	130
Imaging Controls.....	130
B-Mode (2D).....	130
Color Mode (CFM).....	131
Doppler Mode.....	131
Volume Flow.....	132
Annotations – Labels and Bodymarks.....	132
Labels.....	133
Bodymarks.....	133
Measurements and Calculations.....	134
Using the Calculation Package.....	134
Using Reports.....	136
Capturing and Documenting Images.....	137
Cine Review.....	137
Capturing Images.....	138

Copying and Archiving	138
Printing	139
Customization Examples	139
New Presets	139
Default Pro Packages and Presets	140
Making a New Screen Key	141
Vascular Measurement Abbreviations	142
Leg Vein Measurements	142
Artery Measurements	143
Where to Find More Information	145

Chapter 11 Cardiac Pro Package 147

Contents	147
Presets	147
Setting up the Patient – Patient ID	148
Imaging Controls	148
B Mode (2D)	148
M-Mode	148
Color Mode (CFM)	149
Doppler Mode	149
Spectral Doppler Mode	149
Annotations	150
Labels	150
Bodymarks	151
Measurements and Calculations	151
Basic Cardiac Measurements	151
LVV (Left Ventricular Volume)	152
Doppler Measurements	154
HR (Heart Rate)	155
Cardiac Output	156
Using Reports	157
Capturing and Documenting Images	157
Cine Review	157
Capturing Images	157
Copying and Archiving	158
Printing Images	158
Customization Examples	159
Creating a Custom Keyboard Key for M-Mode	159
Customizing Labels and Bodymarks Using Advanced Mode	159
FATE (Focus Assessed Transthoracic Echocardiography)	160
Preset	160
FATE Measurements	160
Where to Find More Information	162

Chapter 12 Urology Prostate Pro Package 163

Contents	163
Diagnostic Presets	163
Setting up the Patient – Patient ID	164
Imaging Controls	164

B Mode (2D).....	164
Annotations – Labels and Bodymarks.....	166
Labels.....	166
Customizing Labels and Bodymarks Using Advanced Mode.....	167
Bodymarks.....	168
Measurements and Calculations.....	169
Automatic Measurement of Prostate Volume.....	169
User Reports.....	170
Capturing and Documenting Images.....	170
Cine Review.....	170
Capturing Images.....	170
Copying and Archiving.....	171
Printing Images.....	171
Customization Examples.....	172
New Presets.....	172
Default Pro Packages and Presets.....	172
Where to Find More Information.....	173

Chapter 13 Surgery Pro Package175

Contents.....	175
Diagnostic Presets.....	175
Setting up the Patient – Patient ID.....	176
Imaging Controls.....	176
B-Mode (2D).....	176
Color Mode (CFM).....	177
Doppler Mode.....	178
Elastography.....	178
Annotations – Labels and Bodymarks.....	178
Labels.....	179
Bodymarks.....	180
Measurements and Calculations.....	180
Distance.....	180
Freehand Measurements – Area and Circumference.....	180
Volume.....	181
Using Reports.....	181
Capturing and Documenting Images.....	181
Cine Review.....	181
The Document Browser.....	182
Capturing Images.....	182
Copying and Archiving.....	182
Printing Images.....	183
Customization Examples.....	184
New Presets.....	184
Default Pro Packages and Presets.....	184
Making a New Screen Key.....	184
Customizing Labels and Bodymarks Using Advanced Mode.....	185
Where to Find More Information.....	186

Chapter 14	Neuro Pro Package	187
	Contents	187
	Diagnostic Presets	187
	Setting up the Patient – Patient ID	188
	Imaging Controls	188
	B Mode (2D)	188
	Color Mode (CFM)	189
	Doppler Mode	190
	Elastography	190
	Annotations – Labels and Bodymarks	190
	Labels	191
	Bodymarks	192
	Measurements and Calculations	193
	Distance	193
	Freehand Measurements – Area and Circumference	193
	Volume	193
	Using Reports	194
	Capturing and Documenting Images	194
	Cine Review	194
	The Document Browser	194
	Capturing Images	195
	Copying and Archiving	195
	Printing Images	195
	Customization Examples	196
	New Presets	196
	Default Pro Packages and Presets	196
	Making a New Screen Key	197
	Customizing Labels and Bodymarks Using Advanced Mode	197
	Where to Find More Information	198
Chapter 15	3D Imaging	199
	Introduction to 3D Ultrasound	199
	3D License	199
	Controlling Transducer Movement	200
	System-Controlled Positioning	200
	The 20R3 Transducer	200
	The Magnetic Wheel Mover	200
	Untracked Freehand Acquisition	200
	3D Imaging Overview	201
	Preparations	202
	Adjusting the Image Capture Settings	203
	ROI (3D Region of Interest)	203
	3D Capture Settings	203
	Acquisition	204
	Viewing a 3D Data Set	204
	Enhancing a 3D View	205
	3D Layout Options	205
	Working with the 3D Image	206
	Manipulating the Volume	206

	Annotating a 3D View	207
	User Views	208
	The 6 Data Presentation Views	208
	Cube View	209
	Render View	211
	MIP View	213
	Transparency View	213
	4-Up View	213
	6-Up View	214
	Save, Capture and Close	214
Chapter 16	DICOM	215
	DICOM on the System	215
	New Patient Information from a DICOM Worklist	215
	Saving or Printing to a DICOM Network	215
	Filenames of Documents Exported in DICOM Format	215
	Archiving to a PACS	216
	Reports	216
	Deleting a Document	217
	Discontinuing an Examination with an MPPS Server	217
Appendix A	Glossary	219
Appendix B	Measurement Abbreviations	225
Appendix C	Setting Up and Customizing Your System	245
	Pro Package and Presets	246
	Doppler and M-Mode Monitor Layout	247
	User-Defined Keys	247
	Assigning User-Defined Keys	249
	Customizing Key Brightness, Mouse Controls and Depth Control	249
	System Setup	250
	General Setup	250
	Clip Storage and Cine Setup	252
	3D Setup	255
	Printer Setup	255
	Password Setup	257
	Network Archiving	258
	Version Information	258
	Video I/O Setup	260
	Battery Support Setup	261
	Miscellaneous System Setup	262
	Measurements	264
	User-Defined Measurements	265
	Curves	269
	Miscellaneous Measurement Setup	272
	Marks (Bodymarks, Labels, Puncture Guides)	274
	Bodymark Setup	274
	Label Setup	274

	Transperineal Matrix, Brachy Matrix and Ruler, and Programmable Puncture Guide Setup	275
	Miscellaneous Marks Setup	281
	Licenses	282
	Importing and Exporting System Configurations	282
	Importing or Exporting Presets	284
	DICOM Setup	287
Appendix D	Redefining Screen Keys – Label, Bodymark, and Measurement	289
	Other Settings	290
Appendix E	Configuring the bk3000 and bk5000	293
	Before You Begin	293
	Configuration Mode	293
	Key Definitions (Redefining an Existing Key)	293
	Unavailable Spaces	295
	The Imaging Tabs	295
	Special 3D Mode Tab	296
	Measure and Mark Tabs	296
	Documentation Tab	296
	Patient Dialog	297
	Display Areas and Info Boxes	297
	Prioritizing the Display of Measurements and Settings	299
	Creating a New Pro Package in Configuration Mode	299
Index		301

Chapter 1

Before You Begin

This is the advanced user guide for the bk3000 and bk5000 Ultrasound Systems.

The *bk3000 & bk5000 User Guide* includes an overview of all the documentation available for the system, including different user guides.

NOTE: *You must read the Safety chapter in the bk3000 & bk5000 User Guide before working with the system.*

This guide takes you deeper into the functionality and potential of the bk3000 and bk5000 Ultrasound Systems.

NOTE: *Some of the functionality and options described in this guide may not be available with your version of the system.*

Questions About the System	Where to Find the Answers
What are the various parts of the monitor display?	"The User Interface" on page 15
Is there an alphabetical list of all the controls on the system?	"Controls on the Monitor" on page 21
How do you make measurements and calculations for an image, and what measurement tools are available?	"Making Measurements" on page 39
How do you manage the images, clips, 3D data sets, and reports that are made on the system?	"Documentation" on page 51
What imaging modes are available on the bk3000 and bk5000?	"Imaging Modes" on page 71 and "3D Imaging" on page 199
What is an examination type, and how does it help with imaging?	"Pro Packages" on page 111
How does DICOM [®] work with the bk3000 and bk5000?	"DICOM" on page 215
What do various abbreviations mean?	"Glossary" on page 219
Can the bk3000 and bk5000 be customized and how?	"Setting Up and Customizing Your System" on page 245, and "Redefining Screen Keys – Label, Bodymark, and Measurement" on page 289,
How do you configure the system?	"Configuring the bk3000 and bk5000" on page 293

Chapter 2

The User Interface

Working with the Monitor

This chapter introduces you to each part of the monitor (Fig 2-1).

For a description of the keyboard, see *Getting Started with bk3000 & bk5000*.

The first 3 steps for imaging are:

- 1 Select a transducer.
- 2 Select an examination type.
- 3 Enter the patient information.

You work in the upper part of the monitor to perform these steps, as shown in Fig 2-1.

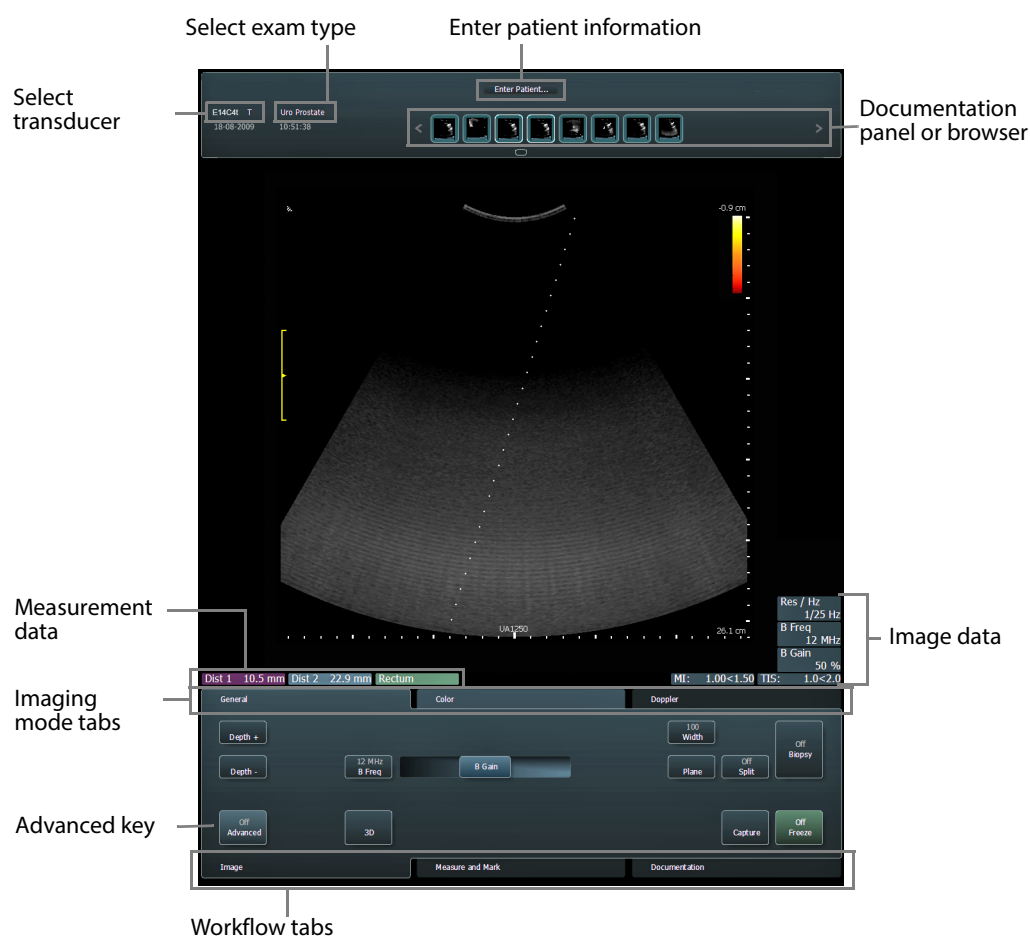

Figure 2-1. The monitor user interface for the bk3000 and bk5000.

Selecting a Transducer

On the drop-down menu, select the transducer that you will use for imaging. Only transducers properly connected to the system appear on the list.

Selecting an Examination Type

The examination type configures your monitor for imaging. An examination type consists of a Pro Package (predefined monitor settings) and a preset (predefined image processing settings). The names of the examination types indicate where they are best suited: urology, gynecology, and so on.

NOTE: Pro Packages are indicated by brighter white text. Yellow text indicates the selected Pro Package and preset (Uro Prostate and Prostate M in this picture).

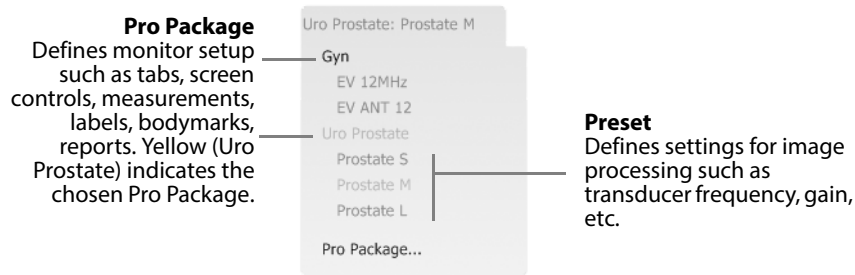

NOTE: A measurement that is set up for one preset in a Pro Package will be available in all presets for that Pro Package.

If you need access to measurements or functions available in other Pro Packages, you can click the Pro Package name instead of a preset name. This will not affect the image setup itself.

The list of Pro Packages displayed depends on which transducers are connected to the system. If the Pro Package you need is not listed, click **Pro Package...**

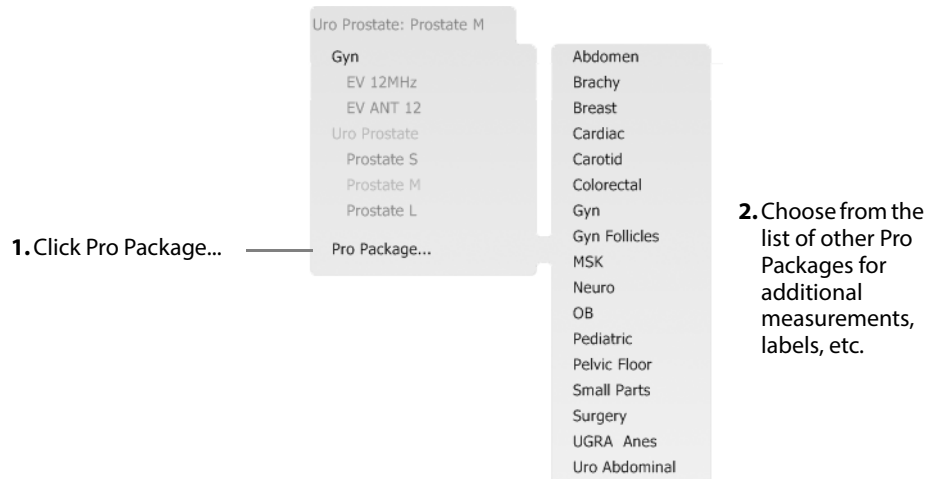

Figure 2-2. Finding a Pro Package from the list of all Pro Packages.

For information about examination types, see Chapter 9, “Pro Packages” on page 111.

Patient Information

After you select the transducer and exam type for your imaging, click the patient information area at the top of the monitor. (It might say **Enter Patient** or contain a patient name or the current time and date). You can also press the **Patient** key on the keyboard. A window opens where you can enter patient information. The fields that are available for entering patient information depend on the examination type.

NOTE: *If you are capturing an image or clip, or using 3D, you must enter a patient name and ID.*

You can configure the patient information area to show the information you want. See Appendix E, “Configuring the bk3000 and bk5000”.

Document Browser

For information about using the Document Browser, see Chapter 6, “Documentation” on page 51.

Measurements and Image Data

For information about making and using measurements on the system, see Chapter 5, “Making Measurements” on page 39.

For information about working with the image, see Chapter 4, “Working with the Image” on page 29.

If measurement data are covered by workflow tabs, minimize the tabs by clicking the top tab.

You can customize which measurement and image data are displayed, where they are displayed on the monitor, and the font size for measurements. For more information about this customization, see Appendix E, “Configuring the bk3000 and bk5000” or consult your BK Medical representative.

Workflow Tabs

Workflow tabs follow the typical workflow of a patient examination. The workflow tabs open automatically as needed so that only relevant controls are displayed.

The tabs are at the bottom of the monitor and are often minimized when you start the system. Click to open them up.

- The **Image** tab is on top when you are imaging.
- When you freeze an image, the **Measure and Mark** tab opens so you can make measurements or annotations.
- When you want to copy, print, or archive documents, or make a report, open the **Documentation** tab.

Minimize all tabs by clicking the top workflow tab. Maximize all tabs by clicking any tab. To open a workflow tab that is not on top, click it.

Most on-screen controls are grouped and displayed as screen keys on the appropriate workflow tabs. You can click a tab to see its controls.

Advanced

By default, only the controls relevant for the situation are displayed.

Click **Advanced** to display *all* available controls for any of the tabs.

NOTE: *Advanced must be on to access Customize, which is where you configure settings as described in “Setting Up and Customizing Your System” on page 245.*

The Image Tab

The **Image** tab is on top when you start to image.

Screen keys on the **Image** workflow tab are grouped on various imaging mode tabs, visible at the top of the workflow tab. Click on an imaging mode tab to open it and see and use its keys.

NOTE: *If an imaging mode tab is active, but its tab is not on top, click the tab to open it and use its keys. If you click the imaging mode tab that is on top, you turn off that imaging mode.*

The imaging mode subtabs for **Image** are:

- General: controls for B-mode
- Color: controls for color mode and power mode
- Doppler: controls for spectral Doppler mode
- M-mode: controls for M-mode.

NOTE: *An imaging mode tab (for example, M-mode) is available only when the examination type is set up to include that mode.*

Capturing a 3D data set is initiated by the **3D** key on the keyboard or by the **3D** controls on the **Image** tab.

3D Tab

Viewing and manipulating a 3D data set can be considered virtual imaging – an additional step in the workflow. When you have captured or recalled a 3D data set, a **3D workflow** tab appears. It may be divided into 2 subtabs, which appear at the top of the tab area, similar to imaging mode tabs.

For information about 3D imaging, see Chapter 15, “3D Imaging” on page 199.

Measure and Mark Tab

The **Measure and Mark** tab opens when you freeze the image.

It contains controls for the measurements and annotations that are set up for the examination type.

Click **More Meas.**, **More Bodymarks** or **More Labels** to see more measurements or annotations than are immediately shown on individual screen keys.

The down arrow on the right of a screen key indicates that clicking the key opens a menu to choose from.

NOTE: *The More screen keys are only visible when Advanced is on.*



Figure 2-3. The More screen keys on the Measure and Mark tab.

If the **Measure and Mark** tab does not contain a screen key you need, you can redefine one of the screen keys. (See Appendix D, “Redefining Screen Keys – Label, Bodymark, and Measurement”.)

You can access any measurement from *any* measurement screen key.

To access any measurement:

- 1 Click **Advanced**.
- 2 Click the circle in the top right corner of a key to open the **Key Definition Menu** and click the *word(s)* that name the measurement, not the *circle* next to it. (See Appendix D, “Redefining Screen Keys – Label, Bodymark, and Measurement”.)

This is handy for a measurement that is used only occasionally.

You can do the same thing for label and bodymark screen keys.

Documentation Tab

After acquiring the image and making measurements, use the **Documentation** tab for saving, reviewing, or deleting the images and reports you made.

Keyboard Control Panel

The keyboard control keys are described in *Getting Started with bk3000 & bk5000*.

Typing Special Letters or Accents

Some special letters are available as keys on the keyboard. In addition, 4 accents are available on the **Accent** key.



Figure 2-4. The Accent key.

To use accents, press the **Accent** key and THEN press the letter that is to be accented.

Examples:

To write this	Press this	Then press this
ö or (Ö)	Accent	o (or Shift + o , for O)
è or (È)	Shift + Accent	e (or Shift + e , for E)
ñ (or Ñ)	fn+ Accent	n (or Shift + n , for N)
ê (or Ê)	Shift + fn+ Accent	e (or Shift + e , for E)

Chapter 3

Controls on the Monitor

This chapter contains a list of all on-screen controls in alphabetical order. Some on-screen controls only appear when **Advanced** is turned on or when the system has been set up to display them. See Appendix C, “Setting Up and Customizing Your System” and Appendix D, “Redefining Screen Keys – Label, Bodymark, and Measurement”. Not all of the controls in the list can be configured by the user.

Monitor Control	Function
%d]	Set the frame number for the end of a cine loop.
[%d	Set the frame number for the beginning of a cine loop.
2D Filter	Set amount of color information smoothing in Color or Power mode.
3D	Turn 3D imaging on or off.
3D Frames	Display the number of frames.
ACI	Turn Angular Compound Imaging on or off to reduce speckle and optimize the ultrasound image. ACI is only supported for some transducers. NOTE: If ACI is turned on, you cannot select number of focal zones.
Advanced	Make all available controls on a tab visible.
All	Select all documents in the browser.
Angle	In Doppler mode, correct the Doppler angle. In 3D, measurement of angle.
Archive	Send to PACS (DICOM), to a network drive, or to a staging area to be burned to a CD/DVD.
Area	3D area measurement.
Arrow	Display an arrow on the image.
Auto	In B-mode, reset overall gain and TGC curve to the default setup for the preset. NOTE: The TGC sliders do not move when you do this. Therefore, the shape of the TGC curve on the monitor may not correspond to the relative position of the sliders on the control panel. In Doppler mode, reset the range and baseline to prevent aliasing and to optimize the display of the Doppler spectrum. NOTE: The keyboard, except for the Freeze key, is disabled while the scale and baseline are being adjusted. This may take a few seconds.
Autofocus	Ensure that the focal range is centered in the displayed image.
Auto Scale	Automatic Scale/PRF adjustment.
B Color	Select a color to tint the B-mode image.
Biopsy	Display a puncture line or brachy matrix.
Bodymark	Place a bodymark on the image.

Monitor Control	Function
Brightness	Adjust monitor brightness.
Burn CD ...	Burn documents from the staging area to CD/DVD.
C Baseline	Reposition the Color mode baseline (offset the Doppler color scale) to help with aliasing problems.
Cancel	Cancel the current procedure or action.
Capture	Save image (if image is frozen) or clip (if imaging) to system hard disk. You must have entered a patient ID to do this.
Capture Multiple Clips	Start capturing a sequence of a pre-defined number of clips.
CFM Steer	Change color box steering angle in Color and Power mode.
Cine Play	Play a cine loop.
Clear All	Clear all measurements, labels, and annotations or 3D sculpting.
Close	Close the 3D Viewer.
Color Level	Adjust color level in the 3D Viewer.
Color Off	Remove the color (flow information) while you are imaging in Color or Power mode. Use this to remove the color temporarily, while keeping the Color box and other settings.
Color Prty	Adjust the priority given to color (flow information). High color priority gives color in more areas; low color priority reduces the number of areas that are colored.
Copy	Copy the selected images to a CD/DVD or USB memory device. An option is available to copy without Patient ID. For HIPAA compliance, this option is recommended.
Cube	3D Cube view.
Customize	Open setup windows for customizing the system.
D Baseline	Reposition the Doppler mode baseline to help with aliasing problems. The frequency axis is updated to match the spectrum.
Delete	Delete the documents selected in the browser.
Depth	Adjust depth. In 3D, adjust sculpting depth.
Depth -	Decrease maximum tissue depth shown (increase image magnification). You can configure this so that it decreases magnification.
Depth +	Increase maximum tissue depth shown (decrease image magnification). You can configure this so that it increases magnification.
D. Freq.	Change Doppler frequency.
Direction	Set direction of a 3D data acquisition.
Display Sculpture	Display 3D sculpture.
Distance	Measure distance in 3D.
Doppler Depth	Doppler Gate depth.

Monitor Control	Function
Dyn. Range	Adjust contrast (dynamic range). Lower dynamic range = higher contrast. Higher dynamic range = lower contrast.
Edge	Edge enhancement. Emphasize contours in B-mode image so that edges stand out more clearly.
End Exam	End current examination.
ETD	Enhanced Tissue Definition (speckle reduction algorithm). ETD can be set at 5 different levels ranging from subtle speckle reduction (level 1) to strong reduction (level 5). The default level is 3; level 0 turns ETD off. NOTE: ETD is not applied to M-mode image when imaging in B+M mode.
Exam List	Open the Examination List in the Archive window.
Extended Res.	Extended Resolution. Obtain better spatial resolution of the image at the cost of a lower frame rate.
Extent	Set extent of a 3D data acquisition.
Filter	Adjust 3D Filter.
Frame	Select a frame of the cine clip.
Freeze/ Unfreeze	Freeze all images on the monitor or start imaging (image update) again.
Freq (B Freq, C Freq, P Freq)	Select imaging (transmitted) frequency (B-mode or Doppler). The current B-mode imaging frequency is displayed on the screen key. (If harmonic imaging is turned on, the displayed frequency (H) is the receiving frequency.)
Full Size	Maximize the size of the image.
Gain (B Gain, C Gain, P Gain, D Gain, M Gain)	Lighten or darken the image in the different imaging modes. When image is frozen, use Post Gain.
Gray Level	Adjust gray level in 3D viewer.
Harmonic	Tissue harmonic imaging on and off. When you turn it off, B-mode imaging resumes with the frequency, gain, dynamic range, and so on, that you were using previously.
Hospital Name	On the image tab, click Advanced . On the System tab, enter name of hospital or institution.
Hue	Adjust hue in 3D viewer.
Import Licenses	Import license keys from a file.
Invert	In Color mode, invert color coding of flow information so that flow towards the transducer appears blue and flow away from the transducer appears red. In Doppler mode, invert the spectrum on the monitor.
Join	Join 2 clips.
L/R	Change the left-right image orientation of all modes in the selected view.
Label	Select a label to put on the image.
Layout	Set the layout for a Doppler/M-mode split screen: vertical or horizontal.

Monitor Control	Function
Lines	You can select the line density of the ultrasound image for B-mode, Color mode, and Power mode. NOTE: You can set different line densities for a mode used (by itself, in the case of B-mode) or in different combinations.
Login .../Logout	Log on to and log out of the network using network username and password. Requires that password protection is enabled.
Luminance	Adjust luminance in 3D Viewer.
Measurement Line Size	Select measurement line size.
MI	Set the maximum allowed mechanical index.
More	On the Measure and Mark tab, display additional measurements, bodymarks, or labels. (Advanced must be on to view the More buttons.)
Multibeam	Increase the frame rate or the line density by receiving signals from several directions.
Needle Strength	Adjusts the visibility of the needle. As you increase the needle strength, the image quality is reduced. Note that this button will only be visible when X-Shine is on.
New	New 3D volume.
Next	Go to next volume slice.
New Exam	Start new examination.
Noise Cutoff	Setup of color map in B-mode.
Noise Limit	Change the noise limit. You can reduce the noise (high frequency disturbances) in the data to improve the accuracy of automatically traced curves. Low noise limits cut out less noise; high limits cut out more.
Noise Reject	Reduce noise in the image, particularly in vascular imaging.
None	Deselect all documents in the browser.
Number of Angles	Set the number of angles for angular compound imaging (ACI).
Opac	Specify the transparency (opacity) of a structure in 3D rendering view.
Orientation	Display or hide orientation markers in 3D volumes.
Pan	Double-click in the image to select and drag it.
Patient ID and Patient Name	Individual patient ID (such as social security no.). NOTE: You must enter a patient ID to capture an image or clip, or to use 3D. Patient name and ID are saved in the patient archive.
Patients with at least one exam of type...	Search entry in patient archive. The types are: Image, Clip, 3D and Report.
Pause Exam	Pause an exam.
Persist	Set the persistence level of the ultrasound image in B-mode, Color mode, and Power mode.

Monitor Control	Function
Photo	Adjust the photorealistic parameter used in 3D rendering view. This can only be used on gray scale volumes.
Plane	With biplane and multiplane transducers, toggle between imaging planes.
Play	Play cine loop.
Post Gain	Adjust the gain of a frozen image. See Gain.
Preset	Select a preset.
Presets	Open menu of presets for enhanced viewing of 3D volumes.
Prev	Go to previous volume slice.
Print	Print the selected documents.
Pro Package	Select a Pro Package.
Real-Time	Turn Real-Time measurements on and off, and select the one you want.
Redo	Redo measurements and annotations.
Report	Open a report for the current examination.
Res/Hz	Shows the balance between resolution and frame rate. Higher resolution number means higher resolution, lower resolution number means faster frame rate.
Reset	Reset the preset to the factory default values.
Rest Position	3D acquisition rest position.
Sample Volume	Resize the Doppler gate to change the area over which Doppler information is collected.
Save...	Save the current setup as a new preset.
Scale	Vary the PRF (pulse repetition frequency) to select the range of Doppler velocities (frequencies) that are displayed in the spectrum and/or color-coded. Restricting the range allows you to see velocity differences (within the range) in more detail. NOTE: The wall filter value will be changed automatically when you change the PRF value.
Sculpture	Turn sculpting of the 3D cube on and off.
Shots Per Est.	Adjust the number of pulses transmitted in each waveform packet at the expense of decreasing the frame rate. NOTE: The Color mode shots may not be the same in B+Color mode as in B+Color+Doppler. Similarly, the Power mode shots may not be same in B+Power mode as in B+Power+Doppler. Changes you make in one case will not affect the other case.
Simultan	Set split-screen view to images simultaneously. (Color or Power mode can be in only one of the views.)
Size	Make the image bigger or smaller.
Smooth	Set how much smoothing is applied to the displayed Doppler spectrum.
Spacing	Set spacing of a 3D data acquisition.
Span	Set the extent of the rotation of a 3D volume.
Speed	Set the speed of the cine movie.

Monitor Control	Function
Split	Split the screen horizontally or vertically to display 2 imaging views at the same time.
Steering	Change the Doppler beam angle in Color, Power, and Doppler modes.
Step	Set the volume measurement step size.
Store Image on PACS	Store the image on a PACS (Picture Archiving and Communications System).
Submode	Select Color or Power submode.
Sweep	In D-mode, set the sweep speed to change the number of cycles of the spectrum displayed on the full time axis. In M-mode, set the speed at which the M-mode image sweeps across the monitor.
Sync. Steer	Independent D-mode/C-mode steering.
Thickness	Set thickness in photo and non-photo mode in 3D.
Time	Set duration of a 3D data acquisition.
Timer	Start or stop a timer on the monitor.
Trace	Activate automatic Doppler curve tracing and specify the type: Peak, Mean+Peak, or Mean. NOTE: Real-Time measurements must be turned on. See Real-Time.
Transducer	Select a transducer.
U/D	Change the up-down image orientation of all modes in the selected view. NOTE: When you change image orientation, you may need to adjust the TGC settings for the B-mode image.
Undo	Undo latest action for measurements, annotations, or sculpting.
Update	See update on control panel. Toggle between B-mode and Doppler.
USB Eject...	Click to eject USB device (flash memory) safely – the system then notifies you when it is safe to remove the device without risk of losing data. If more than one USB device (flash memory) is connected, all will be ejected.
User Views	Open a menu of user-defined views in 3D volume.
VF (real-time)	Activate assisted volume flow estimation.
Video Setup...	Adjust video-in settings.
View	On the Documentation tab, view the selected document from the document browser. In 3D mode, select how the 3D volume is displayed.
Volume	Adjust the volume of the audio signal in Doppler mode. In 3D, measure 3D volume.
Wall Filter	Turn the wall filter on (in Color, Power, or Doppler mode) and set the cut-off frequency.
Width	Narrowing the image width allows for greater frame rate without a loss of image resolution. With some transducers, you can increase the width beyond 100% to expand the field of view.
Wire Frame	Display wire frame on 3D volume.

Monitor Control	Function
X-Shine	Activates the X-Shine function for best needle visibility. Select between On+, On- and Off on the slider.
X-Shine Toggle	Activates the X-Shine function for best needle visibility. Toggle between On+, On- and Off.
Zoom	Zoom 3D volume.

Chapter 4

Working with the Image

Depending on which system you have, you can work with an image (measuring, resizing, etc.) using

- The trackball and its keys to point or click and drag.
- Special keys on the keyboard.
- The keyboard (the physical keyboard or the on-screen keyboard).

Selecting the Imaging Plane

If you are using a transducer with more than one plane, you can select the imaging plane (**T** for transverse, **S** for sagittal, or **E** for endfire). The current imaging plane (**T**, **S**, or **E**) is displayed at the top of the monitor next to the transducer type number.

To select the imaging plane:

- Press the appropriate button on the transducer. For details, see the user guide for the transducer.

or

- Click **T**, **S**, or **E** (whichever is displayed) on the monitor and select the value you want.

or

- Press the **Scanning Plane** key or click **Plane** to toggle through the planes.

NOTE: When you change image orientation U/D, you may need to adjust the TGC settings for the B-mode image. See “TGC” on page 73.

Freezing the Image

When you press the **Freeze** key or click **Freeze**, all images on the monitor are frozen. If you press **Freeze** again, the image returns to its previous state.

NOTE: Some functions are not available when the image is frozen and some are available **only** when the image is frozen. If a control you want to use is dimmed (indicating that it is unavailable), try freezing or unfreezing the image.

When you freeze the image, the date and time displayed on the monitor are also frozen, so the time displayed on a printed image is the time the image was frozen, not the time it was printed.

Partial Freeze and the Update Key

You can only do a partial freeze when you are imaging in Doppler mode as well as one or more 2D modes (B-mode, color, and power) – duplex or triplex imaging. In partial freeze, *either* the Doppler image *or* the 2D-mode image is frozen. You can toggle between the two images in a partial freeze.

To start partial freeze:

- Press the **Update** key.
The partial freeze state starts with all 2D-modes frozen and Doppler mode imaging.

While the partial freeze is active, press the **Update** key to toggle the display between the 2 states, which are

- Doppler mode frozen; 2D-modes imaging.
- 2D-modes frozen; Doppler mode imaging.

To unfreeze both views:

- Long press the **Update** key.

Split Screen

You can split the screen horizontally or vertically to display 2 views side by side or one over the other.

- If you are using a single-plane transducer, the 2 views contain the same imaging view.
- If you are using a biplane transducer, each view displays the image from one imaging plane.
- If simultaneous imaging is turned on, both views can be imaging.

To split the screen or remove a split:

- Click **Split** and select **Vertical**, **Horizontal**, or **Off** (or long press the **Split** key).

NOTE: *In the Uro Prostate Pro Package, you cannot select split orientation. The **Split** screen key works like the **Split** key on the keyboard.*

To select one of the views:

- Click in the view you want to select (or press the **Split** key).

Simultaneous Imaging

The 2 views in a split screen can both be imaging simultaneously; in this case, freezing and unfreezing affect both images.

To turn simultaneous imaging on and off:

- Click **Simultan**.

NOTE: *In simultaneous split-screen imaging, only one of the views can contain Color or Power mode. Therefore, if one view has B+Color or B+Power, the other view contains only a B-mode image.*

You can save a simultaneous split setup (which image is in which part of the monitor) as part of a preset.

Linked Split/Dual

Linked Split/Dual is enabled as a default setting on all Pro Packages. During split screen imaging, the Linked Split/Dual function automatically transfers the parameters from screen A to screen B (and vice versa). Color and power mode can be in only one screen.

To use Split/Dual:

- 1 Adjust the image parameters in screen A, then click screen B to transfer the parameters.
- 2 Use the same method to transfer the parameters from screen B to screen A.

To disable Linked Split/Dual:

- Click the **Linked Split/Dual** button to [Off] on the GUI (Graphic User Interface)

NOTE: *The functionality of the Linked Split/Dual button can be saved as part of a preset. This allows the user to add or remove the button from the GUI as desired.*

NOTE: *In Linked Split/Dual imaging, only one of the views can contain Color or Power mode. Therefore, if one view has B+Color or B+Power, the other view contains only a B-mode image.*

Labels and Bodymarks

In addition to annotating an image during an examination, you can add annotations (labels and bodymarks) to archived images and to individual frames of archived clips from the same type of ultrasound system.

NOTE: *Labels and bodymarks change color when being manipulated. They turn gold when you are able to work with them. When they are blue, they can be moved. When in position and the cursor is not nearby, they are gray.*

Labels

Labels provide a practical way to identify or explain an image. You can:

- Place text labels anywhere on the ultrasound image.
- Add more than one label to an image.
- Type labels directly on the image or select a pre-defined label. When you type, labels are auto-completed from the list of pre-defined labels.
- Change the label to have the opposite orientation word (right/left, up/down, upper/lower, anterior/posterior).

To select a label:

- 1 On the **Measure and Mark** tab, click the label you want. (If you don't see the one you want, click **More Labels** – visible when **Advanced** is on.)
- 2 Use the trackball to move the label and then click when it is in the correct position.

To change an orientation word in a label to its opposite (right/left, up/down, upper/lower, anterior/posterior):

- 1 Select the label.
- 2 Press +/- on the keyboard (either + or - will work).
The orientation word will be replaced by its opposite.

To move a label that you have already positioned:

- Click it and drag it to the new position. Click again when the label is where you want it.

To remove a label:

- Long click the label you want to remove.

To edit a label on the image:

- Click the label on the image and type the changes you want.

Bodymarks

Bodymarks are small bitmaps depicting parts of the body. You can place a bodymark anywhere on the ultrasound image.

You can set up a user-defined key to place a frequently-used bodymark. See “Assigning User-Defined Keys” on page 249.

An imaging plane indicator can be placed on the bodymark to show the imaging position.

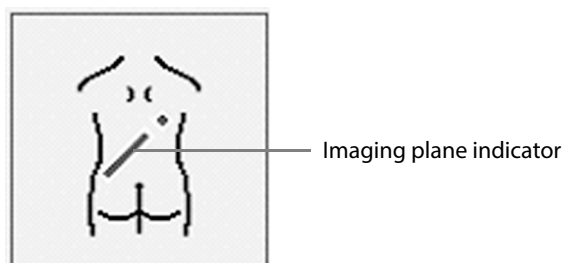

Figure 4-1. Bodymark with imaging plane indicator.

The imaging plane indicator consists of a long bar and small square. The orientation of the bar indicates the orientation of the probe on the body, and the square indicates the part of the probe that corresponds to the upper left of the image on the monitor.

Using Bodymarks

To place a bodymark on the image:

- 1 On the **Measure and Mark** tab, click the bodymark you want. (If you don't see the one you want, click **More Bodymarks** – visible when **Advanced** is on).
The bodymark appears on the monitor with an imaging plane indicator.
- 2 Drag and click the imaging plane indicator to position it; and use the +/- key to rotate it.

To move a bodymark:

- 1 Click on or near it, so that the frame around it turns blue.
- 2 Drag it to the position you want, and click again.

To replace a bodymark:

To replace an existing bodymark with a different one, click the new bodymark on the **Measure and Mark** tab.

To remove a bodymark from the monitor:

- Point at the bodymark and long click it.

Unless you delete it or replace it with a new one, a bodymark will remain on the monitor until you change Pro Packages or begin to image a new patient.

Adjusting the Imaging Plane Indicator**To adjust the imaging plane indicator:**

- On the **Measure and Mark** tab, click the bodymark.

You can then

- Drag the imaging plane indicator with the trackball
- Rotate by pressing the +/- key

Click again when the imaging plane indicator is the way you want it.

Cine

Cine (image review) lets you review a series of the most recently recorded B-mode, B+Color mode, B+M-mode, or B+Doppler mode images.

Freeze the image and turn the **B-Mode** key to scroll backward or forward through the series.

Images are constantly being saved and stored for review. When storage capacity is reached, the oldest images are discarded as new ones are stored. The number of images that can be stored for review varies, depending on such factors as image resolution and size.

Images in a clip must be comparable. Therefore, changing certain parameters that affect the image will cause already-stored images to be discarded. If this happens, there will not be a full set of images to be reviewed until the storage has had time to fill again.

You can change some of the settings for the **CINE** function. For information about changing Cine functions, see “Clip Storage and Cine Setup” on page 252.

Using Cine

To use the Cine function:

- Freeze the image, and when the **Measure and Mark** tab opens, click **Advanced**.

Cine indicators are displayed at the upper right of the tab, depending on the active ProPackage.

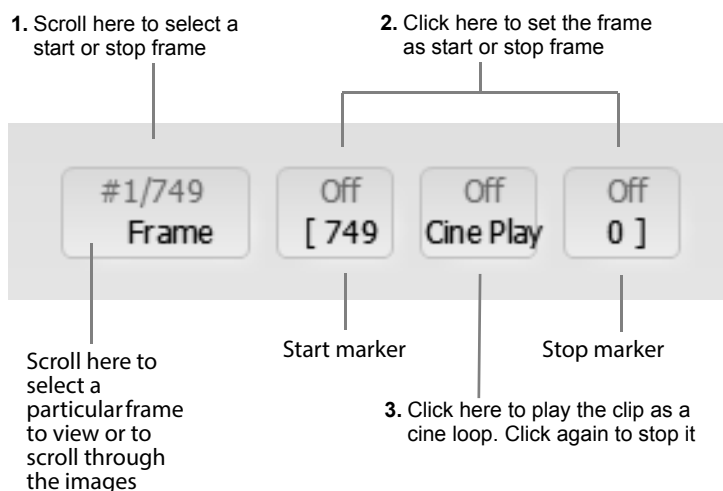

Figure 4-2. Cine indicators.

NOTE: The most recent image is number 1. In Fig 4-2, the frame indicator shows that frame #1 of 749 frames is being displayed. The higher the number, the “older” the frame.

Start and Stop Markers

Set the Start and Stop markers to indicate the range of images to be displayed in **Cine Play**. These markers are shown in Fig 4-2.

NOTE: The image chosen for the Start marker must be older (the Frame number must be higher) than the image chosen for the Stop marker.

During **Cine Play**, the image with the highest frame number (oldest) is displayed first, followed by images with decreasing frame numbers (newer). The current frame and the total number of frames are displayed above **Frame**. After the newest image has been displayed, **Cine Play** will begin to play the loop again, starting with the highest frame number.

Using Cine in M-Mode or Doppler Mode

When cine is activated while imaging in M-mode or Doppler mode, a vertical cine cursor is displayed overlaying the Doppler or M-mode image.

The B-mode image displayed is always the one that corresponds to the position of the Doppler or M-mode cursor. The image (frame) number in the **Frame** indicator corresponds to the B-mode image.

To make measurements on a cine image or save it:

- 1 When the desired image is displayed, click.

2 Make measurements on the image or save it in the usual way.

NOTE: *When you move a cine image after you make a measurement, the measurement result remains, but the markers disappear (because the underlying image is different).*

Video Display

The image can be displayed on an auxiliary video monitor. You can select the video output mode (including OFF). See “Video I/O Setup” on page 260.

The Video Window and Picture in Picture (PiP)

Picture in Picture (PiP) lets you view two types of images at the same time, on the same monitor: an ultrasound image and a video image. The video image can come directly from a camera (on endoscope, for example), or it can be played back from a video recorder.

Using the Video Window

When you display a video image on the monitor (and are not using PiP), the video image appears in a window that covers the ultrasound image and the on-screen controls to the left of the image. This large window is called the *Video Window*.

To activate the video window:

- Click **Video**.

To close the video window:

- Click **Video**.

If you unfreeze the ultrasound image and PiP is not turned on, the video window closes.

Changing the Video Setup

The video setup determines how the video image looks.

You can change the video setup while a video image is displayed in the video or PiP window. You use the **Video Setup** window (Fig 4-3) to specify the video source (the connector on the system and the equipment that is attached to it). The video format (PAL or NTSC) that is set in the **General Setup** window also affects the video input. For information about the **Video Setup** window, see “Video Format” on page 251.

To change the video setup:

- Click **Video Setup**.
The **Video Setup** window appears.

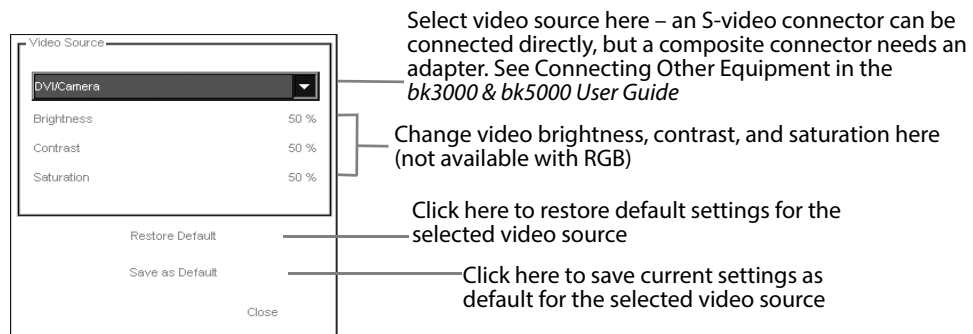



Figure 4-3. The Video Setup window.

NOTE: The equipment names (Camera, VCR, AUX) are just labels so that you can save setups for different equipment. If you plan to use three different composite video cameras, then you can use one of the first three options in the table for each camera.

Using PiP

When you use PiP (Picture in Picture), there are two image windows on the monitor – one large and one small. The *PiP window* is the smaller window. If the main image on the monitor is an ultrasound image, the PiP window contains an external video image. If the main image is a video image, the PiP window contains an ultrasound image.

 PiP must not cover important information	<p>WARNING PIP-1</p> <p>When you use Picture in Picture, do not cover critical information (such as TI or MI) on the monitor. Make sure that all important information will appear if you print or save the ultrasound image.</p>
---	--

If the PiP window is outside the image documentation area, it will not appear when you print the image. You must make sure that the PiP window is in a suitable position for your purposes.

NOTE: If you archive images through DICOM, you cannot change them afterward. If the PiP window covers part of the ultrasound image, you may not be able to make accurate measurements on images archived through DICOM.

To display the PiP window:

- Click **PIP**.

The contents of the PiP window when it opens depends on whether the video window is active (open) when you turn on PiP.

Video Window	PiP Window Contents
Not Active	Video from external video signal
Active	Ultrasound image

Table 4-1. Contents of the PiP window when it opens.

To turn off PiP:

- Click **PIP**.

Adjusting the PiP window

The PiP window can be placed anywhere on the monitor in 3 possible sizes.

To reposition the PiP window:

- 1** Click inside the window.
- 2** Drag the frame to the position you want.
- 3** Click.

The PiP window moves to the new frame position.

- If you decide you do not want to move the window, click again. The frame is not selected anymore.

To change the size of the PiP window:

- Move the cursor so that it is inside the window and press **+/-** to increase or decrease the window size.

or

- Click inside the PiP window and then press **+/-** to increase or decrease the window frame size. When you are finished, the PiP window changes size to fit the frame.

Chapter 5

Making Measurements

Measurements and Calculations

Each Pro Package contains the measuring tools that you need for the calculations contained in the package. You use these tools to measure different aspects of the ultrasound image (and thus the underlying tissue); these measurements are used for various calculations.

You can make measurements on archived images from the same type of ultrasound system. The images must be in DICOM format, not .bmp. For information about the format of stored images, see “HIPAA Compliance and Exporting Data” on page 57. You cannot make measurements on video clips.

For calculation formulas and information about the accuracy of different types of measurements, see “Clinical Measurements: Ranges and Accuracies” in the *bk3000 & bk5000 User Guide* and the Technical Data (BZ2100).

To view the list of measurements:

- 1 Freeze the image.

The **Measure and Mark** tab opens with some measurements for you to select (click).

If the measurement you want is not visible, click **More Meas.** (visible when **Advanced** is on) to find more options.

Making a Measurement – General Procedure

The following sections contain detailed descriptions for using the various measuring tools.

NOTE: *The image must be frozen to make measurements.*

To make a measurement:

- 1 Click the name of the measurement.
A marker appears on the image.
- 2 Drag the marker to the position you want and click.
If the measurement requires 2 markers, another one appears.
- 3 Drag the second marker to the position you want and click.
- 4 Repeat this until you have positioned all the markers for the measurement.

NOTE: *The look of the markers themselves and of any lines that connect them depend on what you are measuring.*

What the Measurements Indicate

- **Results** – The results of the measurement are displayed (continuously updated) below the image. The result is color-coded to match a small square next to the measurement on the image.
- **Depth** – While you are positioning the first marker for a distance measurement in a B-mode or Color mode image, the displayed measurement is the depth of the marker (distance from the marker to the transducer surface along the scan line). When a second marker is positioned, the depth is replaced by the appropriate measurement result.

Clearing a Measurement

There are 2 ways to clear a measurement and any current calculations that use the measurement.

To clear a measurement

- Point at the marker and long click it.
- Point at the measurement result and long click it.

You can also clear all the measurements on the monitor at once.

To clear all measurements

- Long press the **Measure** key.

B-Mode and Color Mode Measuring Tools

This section describes how to make the following types of measurements:

- Distance
- Perpendicular distances
- Angle
- Circle
- Ellipse
- Polygon
- Freehand drawing of shapes

Distance Measuring Tool

Two markers can be positioned to measure a distance, for example, the length or width of a structure. When the first marker is positioned, a second one appears for you to position.

NOTE: *Pressing the **Measure** key starts a distance measurement.*

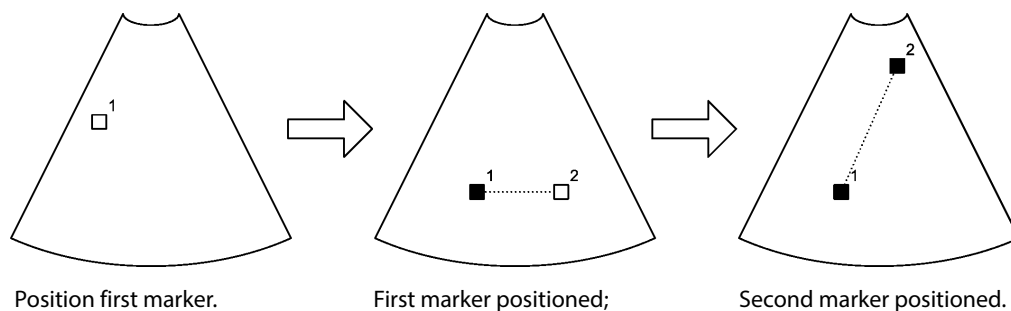

Figure 5-1. Positioning 2 markers on a B-mode or Color mode image.

NOTE: The small numbers (1 and 2) shown in Fig 5-1 indicate the order in which the markers appear. The numbers do not appear like this on the monitor.

To move a marker after they have all been positioned:

- 1 Click the marker.
- 2 Drag it to the new position.
- 3 Click.

Perpendicular Distances

Sometimes it is important for one distance to be measured perpendicular (at right angles) to another distance. In this case, a small square appears at the intersection point when the two measurement lines are perpendicular to each other.

Angle Measuring Tool

On a B-mode or Color mode image, you can measure 1 angle or 2 angles. The angle measuring tool works slightly different from the other measuring tools. The numbers in the following instructions refer to the numbers on the markers in Fig 5-2.

To measure an angle:

- 1 Click **Angle**.
A marker appears.
- 2 Position the marker and click.
A second marker appears, with a line connecting the two markers.
- 3 Position marker #2 to change the angle of the line. Click.
A third marker appears.
- 4 Position marker #3 and click.
A fourth marker appears, with a line connecting it to marker #3.
- 5 Position marker #4 to change the angle of the line. Click.
Angle **alpha** between the two lines is indicated on the image, and the size of the angle appears as a measurement to the left of the image.
If you have chosen to measure 2 angles, additional markers appear for you to measure another angle (**beta**) with the first line.

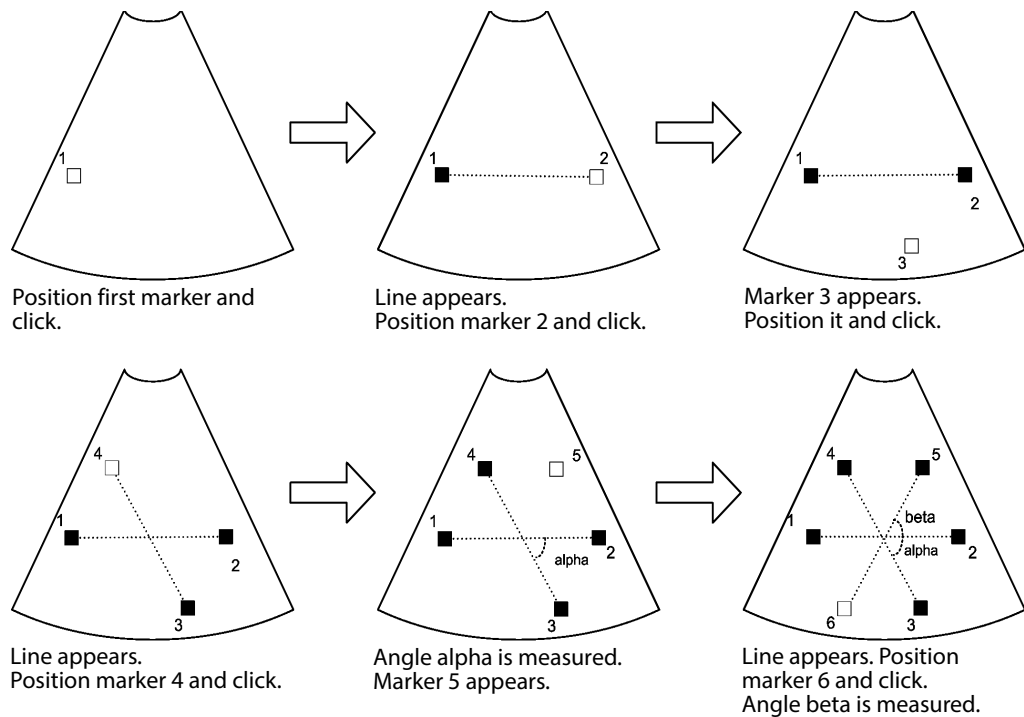

Figure 5-2. Using the angle measuring tool to measure two angles.

If you just click and do not move any markers, the default angles are 60°.

To change the angle measurement after all the lines are positioned:

- 1 Click any marker and move it to change the length or orientation of one of the lines.

NOTE: If you click somewhere on the measuring tool that is not on a particular marker, moving the trackball moves marker #1.

Circle Measuring Tool

On a B-mode or Color mode image, you can position 2 markers to measure a circle. Position the markers in the usual way. As you move the second marker, the circle is continuously redrawn on the monitor.

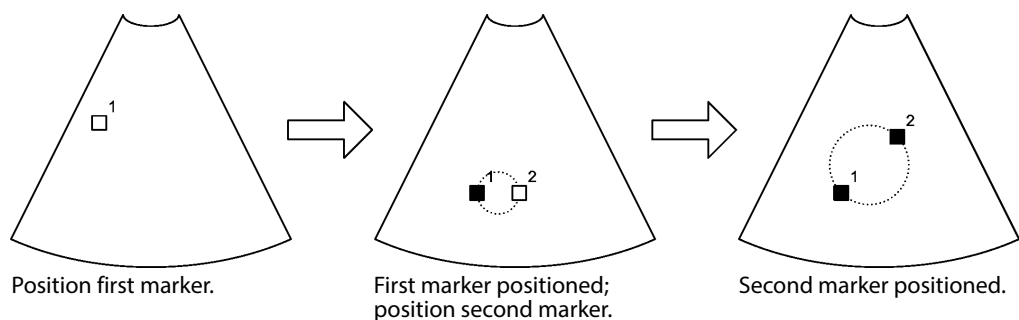

Figure 5-3. Using the circle measuring tool.

After the markers have been positioned, you can move any of them by clicking and dragging to a new location. Click again.

To change the location or size of the circle:

- 1 Click one of the markers
- 2 Reposition the marker.
- 3 Repeat with the other marker, if necessary.

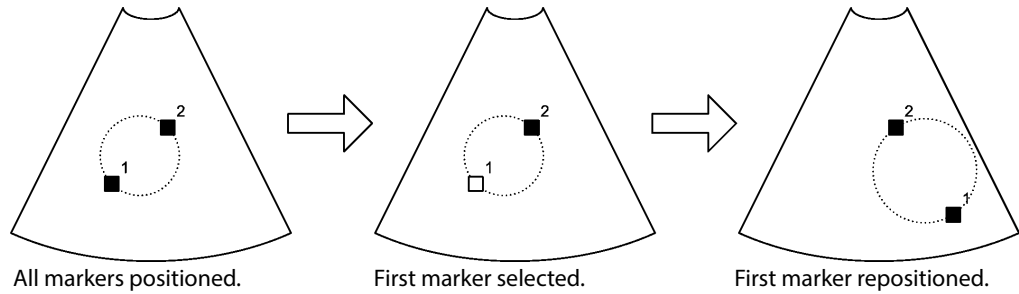

Figure 5-4. Repositioning one of the circle markers.

To move the entire circle without changing its size:

- 1 Click inside or on the circle.
A symbol (a plus sign with arrows) appears as shown in the center image of Fig 5-5. This symbol means you can move the circle.
- 2 Drag it.
- 3 Click again.

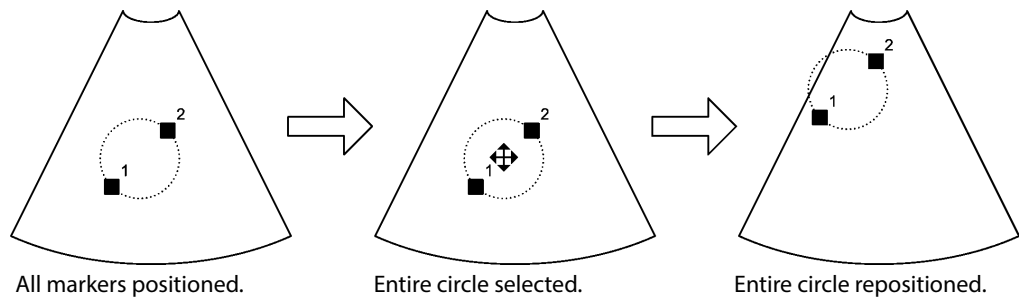

Figure 5-5. Moving an entire circle without changing its size.

Ellipse Measuring Tool

On a B-mode or Color mode image, you can use three markers to measure an ellipse. Position the markers in the usual way.

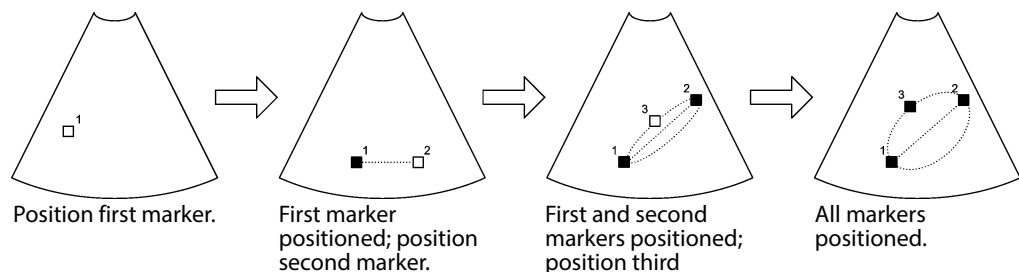
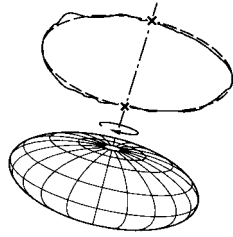

Figure 5-6. Drawing an ellipse.

The first 2 markers determine a line that is used as the axis of rotation if you use the ellipse to measure volume.

NOTE: The axis of rotation critically affects the calculated volume. Consider the basic shape of the structure of interest and make sure to place the first 2 markers so that they define the correct axis of rotation. See Fig 5-7.



Using the shorter distance as axis of rotation results in an estimated volume of the shape shown here.

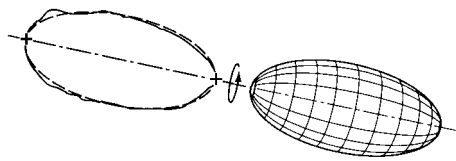

Using the longer distance as axis of rotation results in an estimated volume of the shape shown here.

Figure 5-7. The effect of the rotation axis on volume determination.

The third marker is always equidistant from the first 2. Moving it makes the ellipse broader or narrower. As you move the third marker, the ellipse is continuously redrawn on the monitor.

After the markers have been positioned, you can move any of them by clicking and dragging to a new location. Click again. See Fig 5-8.

NOTE: Moving marker 1 or 2 in an ellipse will automatically move marker 3.

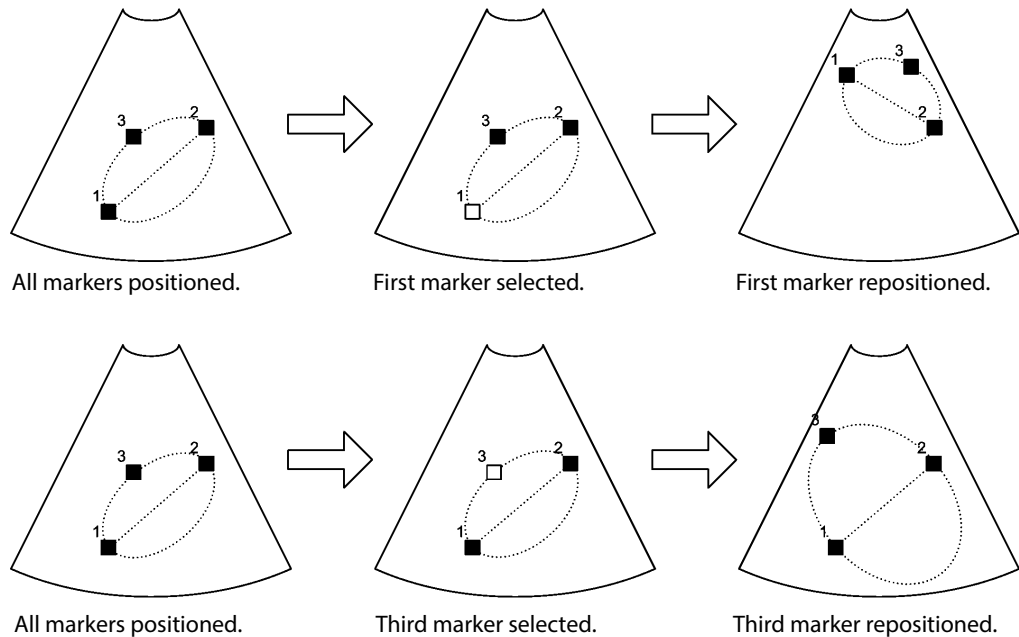

Figure 5-8. Repositioning markers in an ellipse you have drawn.

To move the entire ellipse without changing its size or orientation:

- 1 Click inside or on the ellipse.
The move symbol – plus sign with arrows – appears.
- 2 Drag it.
- 3 Click again.

Not all of the ellipse has to lie within the ultrasound image.

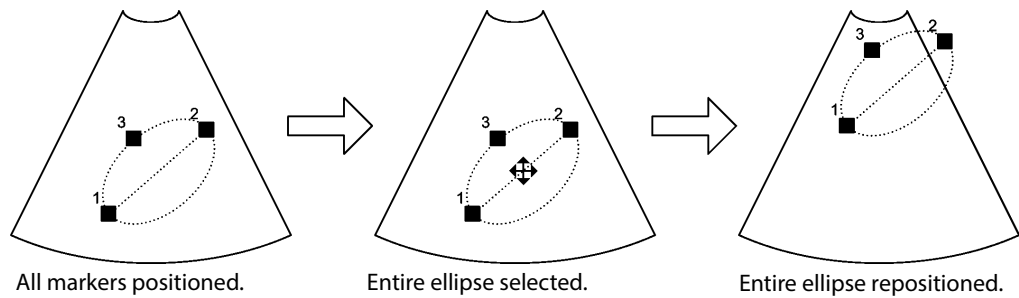

Figure 5-9. Moving an ellipse.

Polygon Measuring Tool

On a B-mode or Color mode image, you can position several markers to define the outline of a polygon. Position the markers in the usual way. After you position one and click it, a new marker appears. A dotted line connecting it to the previously positioned marker is continuously redrawn as you drag the new marker and click it to position it.

To delete the marker you have just positioned:

- Press - on the +/- key.

To undo the deletion:

- Press +.

When you have positioned the final marker you want to use, *double-click* it to indicate that it is the final marker in the polygon. A line is drawn from it to the first marker. No new marker appears after you double-click the final one.

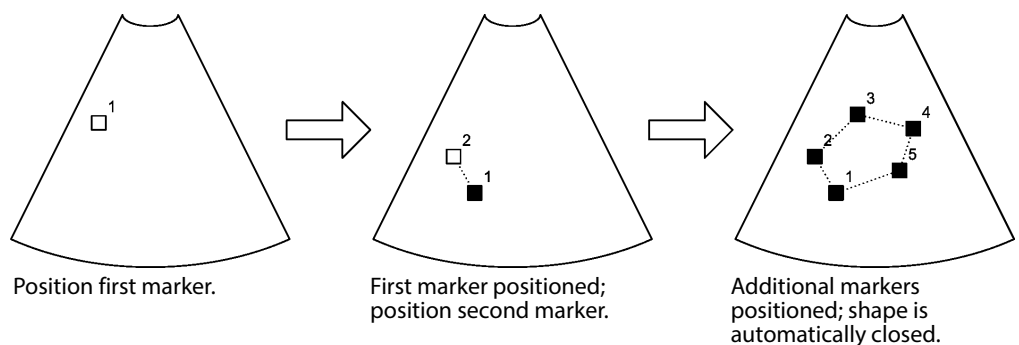

Figure 5-10. Drawing a polygon.

After the markers have been positioned, you can move any of them by clicking and dragging to a new location. Click again.

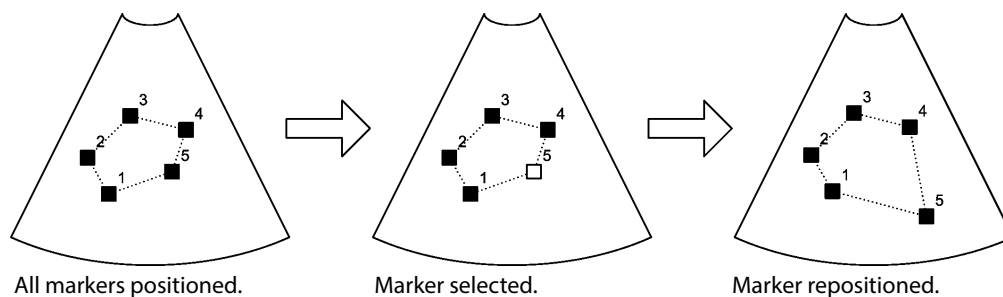

Figure 5-11. Repositioning one of the markers in a polygon.

To move the entire polygon without changing its size or orientation:

- 1 Click inside or on the polygon.
The move symbol – plus sign with arrows – appears (as illustrated in the middle picture in Fig 5-12).
- 2 Drag it.
- 3 Click again.

You can move the shape to any location in the view.

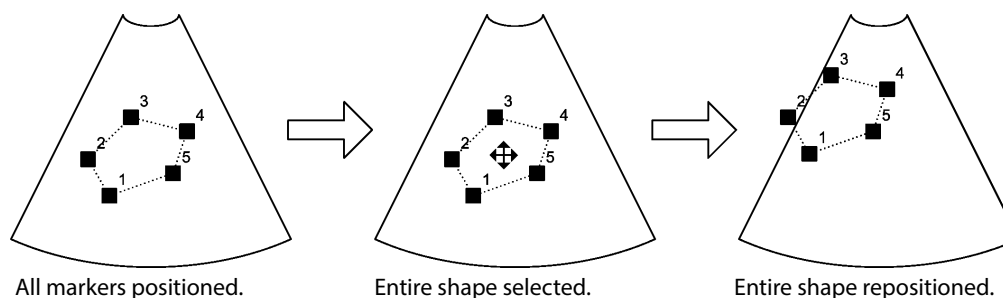



Figure 5-12. Moving a polygon you have drawn.

	<p>WARNING M-w1</p> <p>If the sides of the polygon intersect (as in forming a curve like a figure eight, for example), the area calculation is incorrect. In this case, the calculated area of the polygon is the area of the bigger loop minus the area of the smaller loop.</p>
---	--

Freehand Drawing on a B-Mode or Color Mode Image

On a B-mode or Color mode image, you can draw a closed shape freehand.

To draw freehand:

- 1 Click the measuring tool on the monitor:
A drawing cursor appears.
- 2 Drag it to where you want to start drawing. Click.
A second marker appears where you clicked.
- 3 Drag it to draw the shape you want.
To delete backward from the cursor, press - on the +/- key. The cursor is automatically moved back. To undo the deletion, press +.

- 4 When you have finished drawing, click the drawing cursor.

The shape is automatically closed by a straight line from the drawing marker to the first marker (starting point).

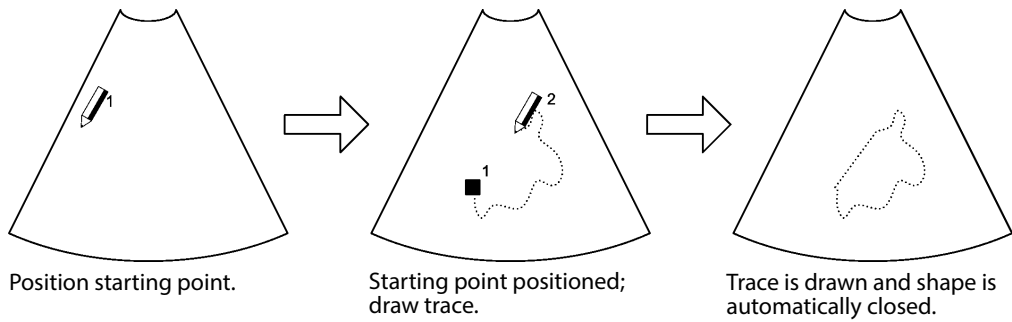

Figure 5-13. Drawing a freehand shape.

You can move the shape to any location in the view.

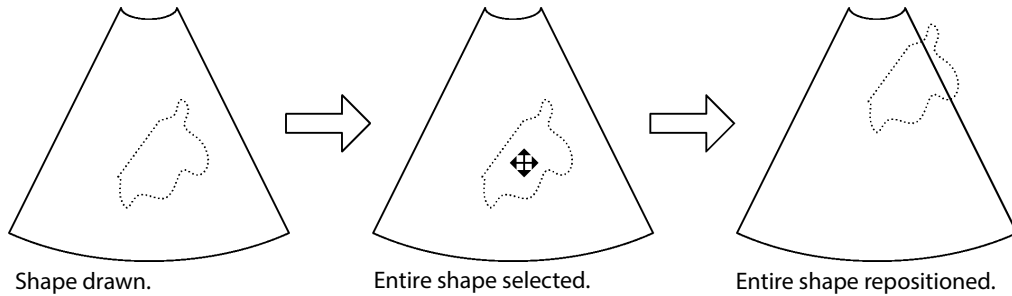

Figure 5-14. Moving a shape you have drawn freehand.

Doppler Mode Measuring Tools

Making measurements on a Doppler mode image is different from measuring on a B-mode or Color mode image because the Doppler mode image has *time* as a dimension. To avoid getting a negative result, successive markers must be positioned to the right, not the left, of any already-positioned markers.

Positioning 2 Point Markers on a Doppler Mode Image

While you are positioning a marker, 2 cursor lines are displayed. One is horizontal and one vertical, intersecting at the marker position.

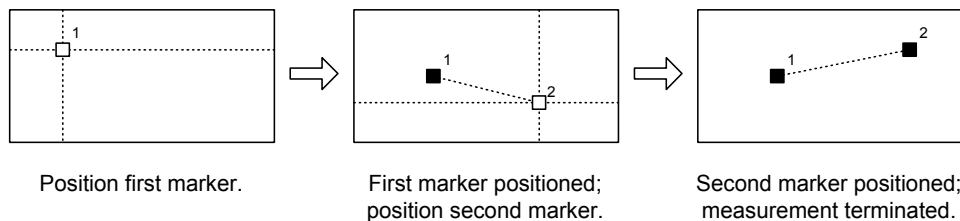

Figure 5-15. Positioning 2 point markers on a Doppler mode image.

After you position the markers, you can move one of them by clicking it and dragging it. Click again when you have positioned it where you want it.

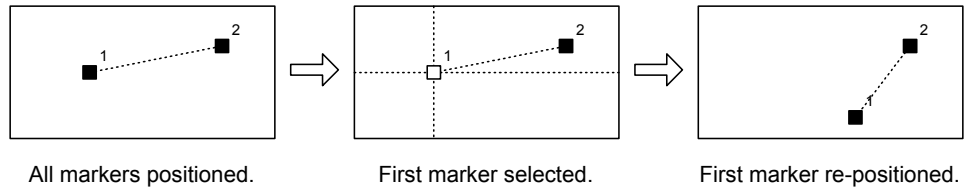

Figure 5-16. Moving a marker you have placed on a Doppler mode image.

You can position the markers anywhere in the Doppler mode image.

The appearance of the markers and whether they are connected by a dotted line depends on what you are measuring.

Positioning 1 Point Marker on a Doppler Mode Image

If you are measuring something that needs only one marker, position the marker in the same way as for 2 markers.

Positioning 2 Vertical Line Markers on a Doppler Mode Image

Two vertical line markers can be positioned on a Doppler mode image to measure intervals.

To position the vertical markers:

- 1 Click the measuring tool.
A marker appears on the image.
- 2 Drag this to the position you want. Click.
Another marker appears.
- 3 Drag it to the correct position. Click.

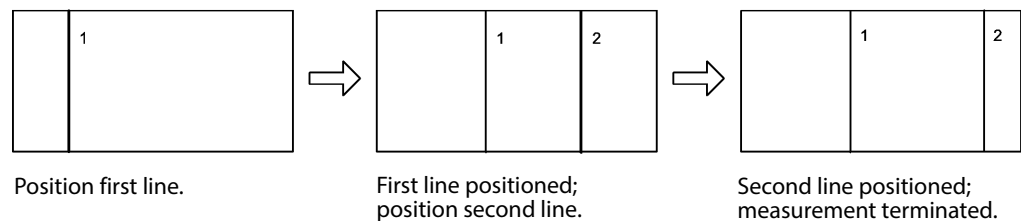

Figure 5-17. Positioning vertical markers on a Doppler mode image.

After you position the markers, you can move one of them by clicking it and dragging it. Click again when you have positioned it where you want it.

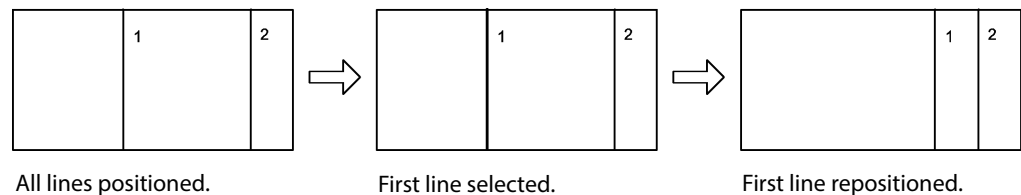

Figure 5-18. Moving a vertical line marker you have placed on a Doppler mode image.

Drawing an Outline Curve on a Doppler Mode Image

On a Doppler mode image, you can draw an outline curve freehand.

To draw freehand:

- 1** Click the measuring tool on the monitor:
A drawing cursor appears.
- 2** Drag it to where you want to start drawing. Click.
A starting point marker appears where you clicked.
- 3** Drag the drawing cursor to draw the shape you want. (You can only drag to the right; you cannot drag to the left.)
To delete backward from the cursor, press - on the +/- key. The cursor is automatically moved back. To undo the deletion, press +.
- 4** When you have finished drawing, click the drawing cursor.

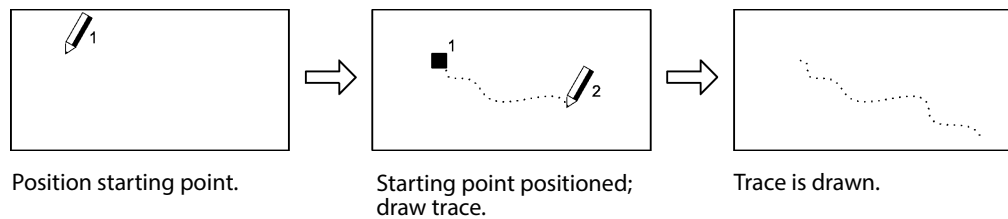

Figure 5-19. Drawing a freehand curve on a Doppler image.

Chapter 6

Documentation

What are Documents?

This chapter describes ways to save, view and delete documents.

There are four different types of documents:

- Images (2D and 3D)
- Clips (2D and video)
- 3D data sets
- Reports

In this chapter, the term “document” refers to all of these types of documents unless a particular type is specified.

HIPAA Compliance

HIPAA (the American Health Insurance Portability and Accountability Act of 1996) sets standards for handling patient data and medical records in a way that ensures the privacy and security of all health-care related data. Each hospital or office must set up procedures to make sure that all information that identifies an individual remains confidential and safe. Always follow the procedures that have been established for your workplace.

Information relating to HIPAA compliance can be found in the various parts of this chapter:

- “HIPAA Compliance and Exporting Data” on page 57
- “Deleting Documents or Exams from the System” on page 64
- “Password Protection of the Patient Archiving System” on page 66

Saving Documents – Capturing Images and Video Clips

You must have a patient ID entered in order to capture images and clips. Normally, you should enter this before you start imaging. If you have forgotten to enter a patient ID, and you have already made some measurements on an image, you can, however, enter the patient ID and not lose the measurement.

To enter patient information for the current image (and measurement):

- 1** Open the **Patient** window (see page 62).
- 2** Enter patient information to start the exam.
- 3** Click **Capture** to capture the current 2D frozen image, with any measurements. If the system is scanning, a clip capture will be started.

Capturing 2D Images

On the **Documentation** tab, click **Capture** to save a 2D image or video clip to the local patient archiving system. This captures an image if the image is frozen and captures clips if the image is not frozen.

Video Clips – Capturing while Imaging

There are two ways to capture video clips when the image is not frozen.

You can use the **Clip Storage and Cine Setup** window (see page 252) to specify (by setting Forward Capture to be **on** or **off**) how your system captures clips. You can also set the default clip length there.

Forward Capture ON

This is the default setting (click once to start recording and again to stop recording).

To record a video clip:

- 1 On the **Image** tab, click **Capture/Capture Clip** to start recording.
- 2 Click **Capture/Capture Clip** again to stop recording.

Forward Capture OFF – Capturing What Has Just Happened

If Forward Capture is OFF, you can capture a video clip based on the cine loop of what has just happened.

To capture a clip of what has just happened:

- 1 Make sure that **Enable forward capture** is not checked. See Fig C-6 on page 253.
- 2 Click **Capture/Capture Clip**.

The last 5 to 30 seconds of video data (from the cine loop) is captured and stored. (You specify the length of the clip in the **Clip Storage and Cine Setup** window; see page 253.)

Capture while Not Imaging

It is possible to continue to capture a clip when you freeze the image, or even to start to capture a clip when the image is frozen. This can be useful if you want to capture the process of making a measurement, for example. If the system is *not* set to capture while not imaging, freezing the image pauses a clip capture that is in progress. You can set up this functionality in the **Clip Storage and Cine Setup** window on page 253.

Capturing 3D Data Sets

3D data sets are automatically saved to the patient archiving system.

Saving Reports

To save a report to the patient archiving system, click **Save** in the report.

Local Patient Archiving System

The local patient archiving system contains information about patients and examinations, including comments about patients or documents.

When you capture an image or save a document during an examination, it is saved directly into the patient archiving system. The document browser is automatically updated to show the saved documents from the current examination.

NOTE: *The patient archiving system can be password-protected. See “Password Protection of the Patient Archiving System” on page 66.*

Reviewing Documents

The Document Browser

Use the document browser at the top of the monitor to review and manage images and other documents stored in the patient archiving system. You can select one or more documents so that you can view, copy, or archive them.

You can also use the document browser to review images and other documents stored or archived on external media, including network drives.

You cannot use the document browser to review images and other documents stored on a Picture Archiving and Communication System (PACS).

The document browser contains thumbnails of the available documents. Each thumbnail includes icons and numbers that give information about the document.

If the browser contains so many images that the thumbnails cannot fit on the monitor, you can use arrows at the left and right end of the document browser to scroll through the thumbnails.

To enlarge the thumbnails, drag the handle (little box) at the bottom of the document browser. If the thumbnails cannot all fit in one row, a second handle appears for you to drag so that the thumbnails are arranged in more than one row.

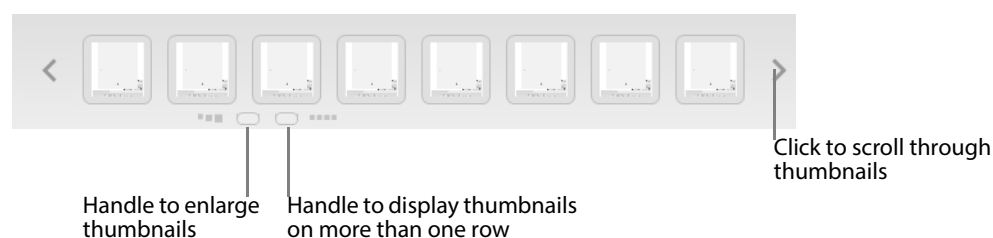

Figure 6-1. The handles and scroll arrows in the document browser.

To select or deselect a document:

- Click the document thumbnail in the browser.
The frame around the document turns blue.

To select or deselect all documents in the browser:

- On the **Documentation** tab, click **All** or **None**.

To view a document:

- Double-click the thumbnail. (You can also click **View**, if there is only one document selected.)
- The frame around the document being viewed turns white.

To see other documents in the patient archiving system, click **View Archive**. The **Archive** window opens. See “Exporting Data” on page 57.

To clear the viewed document from the imaging area:

- Click **Close**.

The letters L and A on the thumbnail indicate whether the document is archived locally or externally. If it is archived both locally and externally, both L and A are shown. (You must enlarge the thumbnail to see the letters.)

Use the controls on the **Documentation** tab to manage the documents in the browser. Some are listed in the following table.

Tool	Function
Report	Open a report for the current examination.
Exam List	Open the Archive window.
Join	Join selected video clips into one large clip. The selected clips are deleted and replaced by the new large clip. The time label of the new clip is the latest time of the selected clips.
All	Select all thumbnails in the document browser.
None	Deselects all thumbnails in the document browser.
View	Display the currently selected document (2D image, 2D video clip, 3D data set, Pro Package report). If more than one document is selected, clicking View has no effect.
Delete	Delete the currently selected documents (see page 64).
Archive	Place documents in the staging area so that they can be burned on an archive CD or archive them on a network drive or PACS.
Copy	Copy documents to CD/DVD or USB storage device, with or without patient ID. For patient security, it is recommended to remove the patient ID. Reports cannot be copied with the patient ID removed. Documents to be copied to a CD are placed in a staging area (see “Staging Area” on page 58) so that they can be collected to be burned on a copy CD/DVD. You can also copy to a CD/DVD or a USB storage device in DICOM format.
Print	Print selected 2D images or all 2D images from selected patients or examinations. You can select the printer, including a DICOM printer, if your system is set up as part of a DICOM network. You cannot print clips, 3D images, or reports to a DICOM printer or to a video printer.
End Exam	Closes current exam. Click Enter Patient... to start a new exam.

Table 6-1. Documentation screen keys.

Viewing and Editing Video Clips

Viewing and Editing a Video Clip on the System

When you view a video clip or cine image, there are special controls at the top of the **Documentation** tab that you can use to play, pause, go forward, or go back. You can also edit the clip.

NOTE: *Video clips are not displayed on an external monitor.*







Video Clip Control	Function
	Slider indicates current position in clip. When the clip is paused, you can click the slider and move back and forth in the clip. See description of cursors below.
	Play, Pause. Only one of these is visible at a time.
	Click to move the clip one frame backward or forward. Works when clip is paused.
	Left and right cursors. Click the icon to place the cursor next to the slider at the current position in the clip. When the cursors are present, as shown with the slider in the first row of this table, the clip will start from the position of the left cursor and stop at the right cursor.
	Cut. Click this to cut away (remove) the part of the clip that is between the cursors. Both cursors must be positioned before you cut.
	Crop. Click this to remove the part of the clip that is outside the cursor(s). At least one cursor must be positioned before you crop.
Close Review	Closes the review in the image area. Changes made with Cut and Crop are stored as a new clip that is added to the examination. After the review is closed, you can delete the original clip if you want to keep only the edited clip.

Table 6-2. Viewing and editing controls for video clips.

Viewing Exported Documents on the System

Documents that have been archived or copied to external storage media can be viewed on an ultrasound system.

Documents that have been archived to a network drive can be accessed, just like documents stored on the system, by selecting an examination in the **Archive** window. (See page 57.)

You can use the document browser to look through documents that you have copied or archived to a CD/DVD, network drive or USB storage device.

To view externally stored documents:

- 1 Insert a CD/DVD or insert a USB storage device into the USB connector on the left side of the keyboard.
- 2 Click the **CD/USB** tab at the bottom of the **Archive** window.

A list of the folders on the external storage devices appears.

- 3** Click **Update** in the **Archive** window.
- 4** Click to select a folder.

The document browser is updated with the documents in the selected folder.

Viewing Exported Documents on an External Computer

Formats of Exported Documents

Copied Images Images copied to a CD or USB storage device are stored in DICOM or .bmp format. In .bmp format, they are labeled with a code that specifies the date and time the image was captured. For example, 2D_20131022_135426_FV12345.bmp would be the label on an 2D image of patient FV12345 that was captured on October 22, 2013 at 1:54:26 P.M. (13:54:26). The label on a DICOM file is the same except that the file extension is .dcm.

Copied Video Clips Video clips can be copied in .avi or DICOM format.

Archived Images and Video Clips Archived images and video clips (including ones archived on the system) are stored in DICOM format.

Viewing Images on a Computer

NOTE: *DICOM format requires a DICOM viewer on your computer.*

Copied images have been exported in DICOM or bmp. format. You select the file you want to view.

All *archived* images, whether on the system or on a CD, network drive or PACS system, are stored in a DICOM format; you will not be able to read externally archived documents on a computer unless you have a DICOM viewer.

Viewing Video Clips on a Computer

If the video clip has been exported in DICOM format, you can view it with a DICOM viewer.

If the video clip is not saved in DICOM format, you can still view it on a PC, but you must have a codec installed on the PC. You can set up the system to export the codec to an external storage medium (see page 254). The codec is exported to a folder called **Codec**.

To install the codec on your PC:

- 1** Use Windows® Explorer to view the contents of your external storage medium.
- 2** Open the folder called **Codec**.
- 3** Right-click the file called **lagarith.inf** and click **Install**.

The codec is installed.

NOTE: *Lagarith version 1.3.27.0 is required.*

Exporting Data

You can copy and archive documents so that they are stored outside the system.

Copying When you copy a document, only the document is copied, and not the patient database. You can copy documents to a CD/DVD or a USB storage device.

Archiving When you archive a document, the patient database is copied along with the document. This ensures that you have a backup of the patient database as well as ultrasound images in case anything happens to the system hard disk.

You can archive documents to a CD or a network drive. You can also archive them to a Picture Archiving and Communications System (PACS).

HIPAA Compliance and Exporting Data

To preserve patient confidentiality when you copy patient data, select the option to copy images and other documents to a CD or USB storage device *without the identifying patient information*: **without patient ID**.

If you archive to a CD/DVD or network drive, the archive is password-protected, but you must still be aware that you are exporting confidential data from the system.

Copying to a CD/DVD or USB Storage Device

You can copy documents associated with a patient to a CD/DVD or USB storage device. The system is set up to copy to one type of device or the other.

You can make more than one copy of a document.

See “Using CD/DVDs” on page 58 and “Using USB Storage Devices” on page 60.

To copy individual documents or all the documents associated with a specific examination or patient:

- 1 Click to select the patient, the examination, or the individual documents you want to copy.
- 2 Click **Copy**.
- 3 Select the destination and whether you want to copy in DICOM format or not. Copying the document **without patient ID** is recommended for patient security.
- 4 The documents are copied to the staging area for burning to a CD/DVD (see “Staging Area” on page 58) or to the USB storage device.

Archiving to a CD/DVD or Network Drive

To keep a permanent record of documents, you can archive them to a CD/DVD or a network drive. See “Using CD/DVDs” on page 58 and “Using a Network Drive” on page 60.

NOTE: *Archiving must be done to an empty CD/DVD. After you have archived documents to a CD, you cannot use the same CD again for archiving.*

You can archive a document to a CD/DVD or network drive only once. This means that you cannot archive the same document to both a CD/DVD and a network drive. The system keeps a record of where the document has been archived so that you can always find an archived document.

To archive all documents for a patient or examination or individual documents:

- 1 Click to select the patient, the examination, or the individual documents you want to archive.
- 2 Click **Archive** on the **Documentation** tab.
- 3 Select the archive location.
If you archive to a CD/DVD, you are asked for a volume name.

Using CD/DVDs

There are certain restrictions about copying and archiving to a CD/DVD:

- You cannot burn both archived and non-archived documents to the same CD/DVD.
- You cannot archive to a CD/DVD that is not blank.
- Problems can arise if one CD/DVD-burning program has been used to burn data to a CD/DVD and you try to add new data using a different burning program. The current system may use a different burning program from the one on older systems.

NOTE: *CD/DVDs are vulnerable, and data may be corrupted when they are saved to a CD/DVD. After you save, check the CD/DVD to make sure that your data are saved properly.*

Remove the CD/DVD from the system before you turn it off because data can also be corrupted when the system shuts down.

We recommend DVD-RW, DVD-R, CD-RW, and CD-R for use with BK equipment.

Staging Area

When you copy or archive to a CD/DVD, the selected documents are not copied immediately to a CD/DVD. They are moved to a staging area. You can add more files to the staging area before you burn them to a CD/DVD.

Set the size of the staging area to match the size of the CD/DVD. See “Setting the CD/DVD Size” on page 252.

Files in the staging area do not disappear when you turn off the system. When you turn on the system, you are reminded if there are files in the staging area.

If you try to copy or archive documents and the total size, including what is already in the staging area, is too big to fit on a CD/DVD, you are informed that you cannot copy the documents to the staging area.

Burning a CD/DVD

To burn archives or copies to a CD/DVD:

- 1 Insert a CD/DVD into the DVD drive.
- 2 Click **Burn CD ...**

The following window appears:

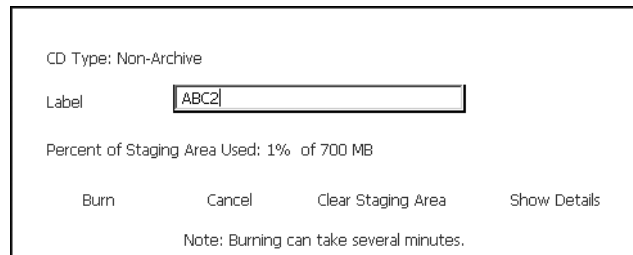

Figure 6-2. The Burn CD window.

- 3 If you are burning a copy, you must type a label name.
If you are burning an archive CD, you cannot specify the label name here.

- 4 Click **Burn**.

The progress bar tells you when the burning is finished. The keyboard and on-screen controls are disabled while the CD is being burned.

Reviewing and Deleting Documents in the Staging Area

You can also use the **Burn CD** window (Fig 6-2) to examine the contents of the staging area and to delete individual documents or clear all documents.

To review and edit the contents of the staging area:

- Click **Show Details**.

The staging area browser appears in the **Burn CD** window.

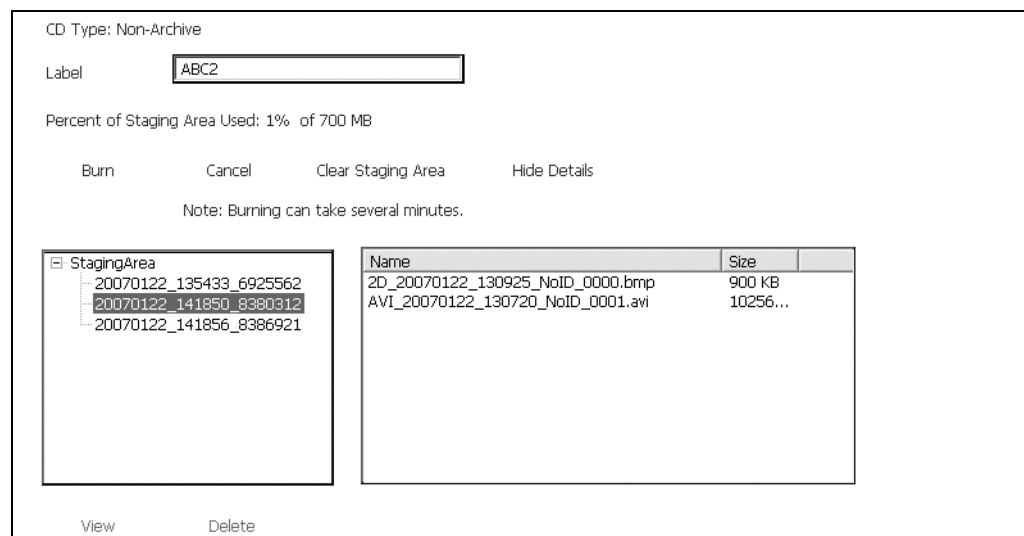

Figure 6-3. The staging area browser in the Burn CD window.

The list on the left side contains a list (labeled with the time) of selections you have put in the staging area.

If you click an item in the left-hand list, information about the individual documents it contains appears in the right-hand list.

To view a document in the staging area:

- Select it in the right-hand list and click **View**.

To delete individual documents from the staging area:

- Select them (you can select more than one) and click **Delete**.

NOTE: *Be sure you have selected the correct documents to delete because they are deleted from the staging area as soon as you click Delete. You are not prompted to confirm that you want to delete them.*

To clear all documents from the staging area:

- Click **Clear Staging Area**.

NOTE: *When you clear the staging area, there is a risk of losing data if you have put something there (for example by clicking **Copy**) and then deleted it from the local patient archiving system. You are asked to confirm the deletion.*

NOTE: *Do not delete documents from the local patient archiving system until you have verified that they have been externally archived successfully.*

Using USB Storage Devices

If the system is set up to copy to a USB storage device, when you click **Copy**, the copying starts immediately. (Unlike for CD/DVDs, there is no staging area.) If more than one USB storage device is connected, choose the local volume to copy to from the list that appears.

NOTE: *Some USB storage devices are configured as two partitions (for example, D: and E:).*

NOTE: *Before you remove the storage device, click **USB Eject**. You will be notified when it is safe to remove the storage device (no risk of losing data). If more than one storage device is connected, both will be ejected.*

Using a Network Drive

A network drive can be set up for archiving. See “Network Archiving” on page 258.

Network Password

To access the network drive from the system, you need to log on to the network using your network username and password. There are 3 ways you can do this:

- You are prompted for the network username and password each time you try to access the network.
- If you use your network username and password as your system username and password, you can leave the password field blank (for greater security) when you set up network archiving. Then when you try to access the network drive (when you are logged on to the system), the system logs you on with your system username and password.
- If you enter the network username and password when you set up network archiving, the system remembers it for you and logs you in automatically. This is the least secure method.

The Archive Window (Examination List and Patient Information)

You use the **Archive** window together with the document browser to manage all the documents in the patient archiving system. You can view documents, delete documents, copy documents, archive documents, and send them to a PACS or a DICOM printer.

The **Archive** window also contains information about how much space is left on the system hard disk. See “Hard Disk Quota” on page 67 for more information about the hard disk quota and how to create space on the hard disk.

To open the Archive window:

- 1 Press the **Patient** key or click the patient ID at the top of the monitor.
- 2 In the window that opens, click the **Archive** tab.

A list of examinations is displayed, including each examination for each patient. Each row represents one examination of one patient.

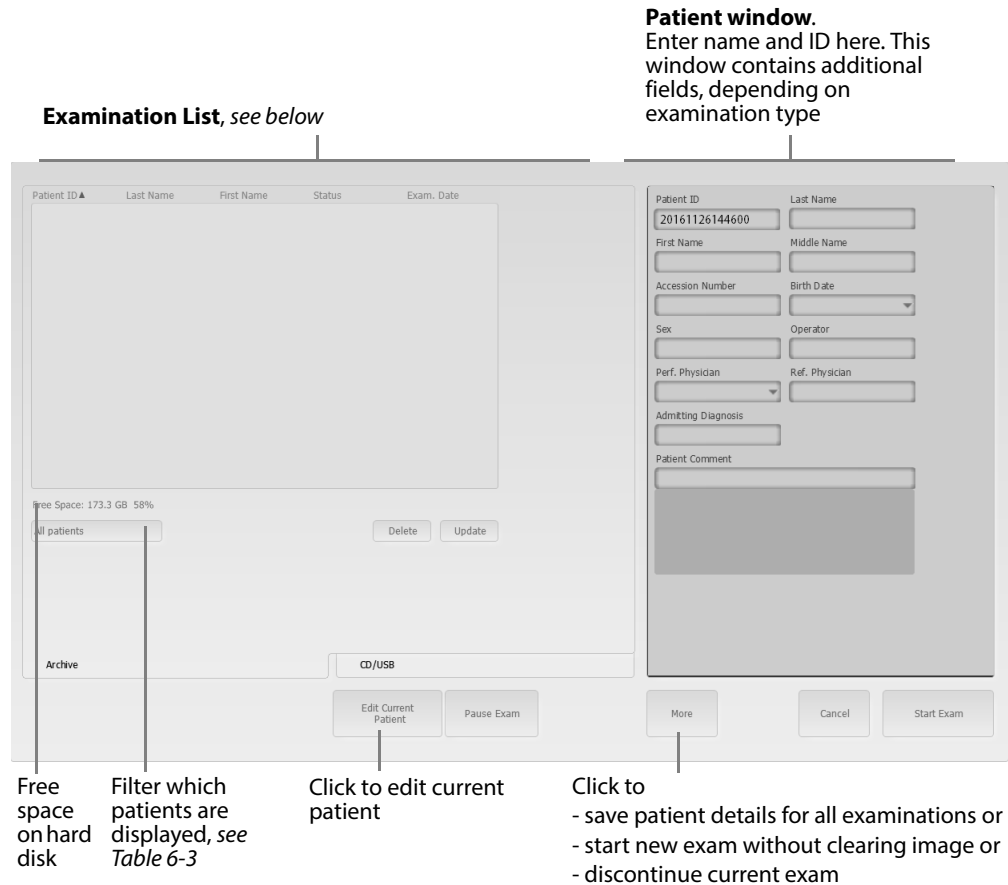

Figure 6-4. The Archive window with the Examination List and the Patient window.

Patient Information

To edit the current patient:

- 1 Click **Edit Patient**.
- 2 If you want the changes to apply to already archived examinations for that patient, click **More**, then **Save patient details**.
If you want to change the details only for the current exam, click **Continue Current Exam**.

After you do that, you can click to start a new exam without clearing the image. To discontinue the current exam, click **More**.

If you forgot to enter new patient details before you started imaging, you can keep the image while you add patient information.

To start a new exam without clearing the image:

- Click **More**, then **Start new exam without clearing the image**.

Examination List

The **Examination List** contains patient IDs, names, and other information about patients in the patient archive, including the date of the last examination.

You can sort the listed patients according to the information in one of the columns by clicking the column heading. For example, if you click the **Last Name** column, the listed patients will be sorted alphabetically by last name.

To see documents from a particular examination, click the row containing the examination. You can select more than one by holding down the **Ctrl** key. The document browser is updated with the thumbnails of documents from the selected examinations.

You can use the controls below the list to filter the information so that only certain patients and examinations are displayed (see Table 6-3).

Select this	Enter this in the next field	Examinations displayed for these patients
Current patient	<i>Not applicable</i>	The current patient (the one whose ID is displayed at the top of the monitor)
Patients examined today	<i>Not applicable</i>	All patients that have been examined today
All patients	<i>Not applicable</i>	All patients
Patients with exams before...	A date	All patients who have any examination before the date you enter
Patients with exams after...	A date	All patients who have any examination after the date you enter
Patients with data including...	Smith	Patients named Smith, Smiths, Smithson, Whitesmith and those with other names containing "Smith"
	1975	All patients born in 1975
Patient with patient ID	the exact patient ID	The patient with a specific patient ID
Patients with comments including...	"severe" (for example)	All patients with a patient comment that contains "severe"
Patients with document comments including...	"tumor" (for example)	All patients with a document comment that contains "tumor"
Not archived	<i>Not applicable</i>	All patients that have no archived examinations
All archived	<i>Not applicable</i>	All patients with at least one archived examination
Patients with uncommitted documents	<i>Not applicable</i>	All patients with uncommitted documents.
Patients with committed documents	<i>Not applicable</i>	All patients with committed documents.
Patients with discontinued examinations	<i>Not applicable</i>	All patients with discontinued examinations.

Table 6-3. Ways to select the patients displayed in the Examination List.

Hiding Part or All of the Examination List

You may not want all patients to be visible when the **Examination List** is displayed. You can control which patients appear by setting a filter to be active by default. See “Miscellaneous System Setup” on page 262.

Deleting Documents or Exams from the System

NOTE: *In rare circumstances, you may want to clear (delete) the entire patient archive from the system. If you do, see “Miscellaneous System Setup” on page 262.*

You can delete documents from the system if they have not been archived externally. If they have been archived externally, you can delete the documents themselves from the system, but the patient and the reference to the externally archived documents remain.

NOTE: *You cannot delete a document that is in a queue to be sent to a DICOM device.*

You can delete a patient record from the system if the patient has no externally archived documents.

To delete one or more documents (archived or non-archived) from the system:

- 1 Click the images in the document browser to select them.
- 2 Click **Delete** on the **Documentation** tab and confirm that you want to delete the documents.

The selected documents are deleted. If they were archived before they were deleted, the examination record, with a reference to where the documents are archived, remains on the system.

To delete all documents associated with an examination:

- 1 Click to select the examination. To select more than one row, press **Ctrl** while you click.
- 2 Click **Delete** on the **Documentation** tab and confirm that you want to delete the documents.

The documents associated with the selected examinations are deleted.

NOTE: *The examination record itself is never deleted (unless you delete the patient).*

To delete an exam with no externally archived documents:

- 1 Click to select the row containing the exam. To select more than one row, press **Ctrl** while you click.
- 2 Click **Delete** on the **Documentation** tab.
You are asked to confirm that you want to delete the exam.
- 3 Click **Yes**.

All local documents for the exam are deleted. The exam is deleted in the patient archive if documents for the patient have not been externally archived (that is, if they only appeared locally in the patient archiving system).

Starting a New Examination from the Examination List

You can start a new examination from the **Archive** window. If a patient is selected in the window, the **Patient** window that opens contains patient data for that patient.

If no patient is selected in the **Archive** window, the **Patient** window that opens is empty.

You can also open the **Patient** window by clicking the Patient name (or **Enter Patient**) at the top of the monitor or pressing the **Patient** key.

Entering Dates

There are 2 ways to enter dates:

- Type the date in the date field. When you click in the field, the displayed date changes to indicate the correct (numeric) format for entering the date. You must type in numbers for the day, month, and year even if the date is going to be displayed with the month spelled out.

If you type a date that is not allowed (for example, type 22 for the month), the date is displayed in red until you enter a valid date.

- Select the date from a calendar. Click the arrow to the right of the date field to open the calendar.



1. Click the arrows to scroll through month and year. Right-click (use + side of +/- key to move back and forth in 10-year steps).

2. Then click to select the day.

Start Exam

After you have filled in the window, click **Start Exam** (or press **Freeze** twice) to start the exam.

Pausing and Later Resuming an Examination

It is possible to pause an exam (for example, while you examine a different patient) and then resume the exam with the first patient. Refer to the illustration of the **Archive** window in Fig 6-4 on page 62 when reading the following procedures.

To pause an examination:

- Open the **Archive** window and click **Pause Exam**.

To resume a paused examination:

- 1 Open the **Archive** window.
- 2 From the **Examination List**, select an exam with the status **Pause**.
- 3 Click **Resume Exam**.

NOTE: Do NOT select a paused exam and click **Start Exam** to try to resume it. Clicking **Start Exam** starts a NEW exam for the patient.

Password Protection of the Patient Archiving System

To help comply with HIPAA standards, the patient archive database on the system can be password-protected with a user-specific ID (username) and password.

NOTE: If you archive documents to a CD, the database copy on the CD is protected with a different password. See “Viewing Images on a Computer” on page 56.

If the database on the system is password-protected, when you turn on the system, a login window appears:

The image shows a login window with a light gray background and a black border. It contains two text input fields: the first is labeled "Username:" and the second is labeled "Password:". Below these fields are three buttons: "OK", "Cancel", and "Emergency".

Figure 6-5. The login window.

Enter your system username and password and click **OK**. To change your password, see “Password Setup” on page 257.

Not Logged In

If you click **Cancel** in the window, you can use the system but you cannot use the patient archiving system or the 3D system. This means you cannot capture images or clips or 3D data sets. You also cannot see patient information or documents in the patient archiving system.

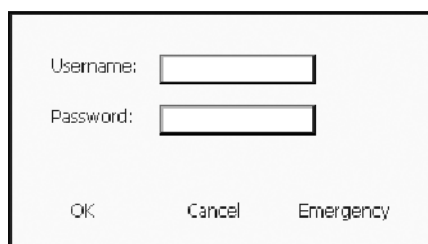
If you start the 3D system, the login window appears. If you log in, you are allowed to use the 3D system (if you have a license for it).

The login window also appears if you try to enter a patient ID when you are not logged in.

Emergency State

In an emergency, someone without a password may need to use the system and there may not be time to type in a name and patient ID. In this case, when the login window appears, click **Emergency**. This puts the system in the emergency state.

In the emergency state, a default patient ID (“EmergencyID”) is used. You can capture images and clips, but they will all have “EmergencyID” as the patient ID.

NOTE: If you have clicked *Emergency* in the login window, do not send pictures to a PACS because they will be identified as *EmergencyID* and you will not be able to identify pictures from different patients.

You can log in with your password at any time. When you do that, the emergency ID disappears and you must enter a patient ID.

Hard Disk Quota

The system hard disk does not have unlimited storage capacity.

The system checks the space on the hard disk each time you enter a new patient ID. If the hard disk is getting full, you will be notified:

- when there is less than 2 GB available space on the hard disk.
- when there is less than 1.5 GB available on the hard disk.
- when there is less than 1 GB available on the hard disk. At this point, you will not be allowed to save any more information to the hard disk.

To clear space on the hard disk, you must delete some documents. You can archive them to a CD, DVD, or PACS (if you have DICOM installed) before you delete them from the hard disk.

NOTE: *If you have archived the documents to a CD/DVD, wait to delete them from the hard disk until you have successfully burned the archive CD/DVD. See “Using CD/DVDs” on page 58. If you have archived them to a PACS, make sure that they have been transferred successfully into the system before you delete them from the system hard disk.*

Reports

Reports are defined for each Pro Package. A report contains information about the patient and the measurements you have made. You can add remarks, patient comments and images to a report.

You can save a report to the patient archiving system and view, save or archive it in the same way as you view or save other documents. See page 55. for more information.

Creating a Report

To create a report:

- On the **Documentation** tab, click **Report**.

Obstetrics Report						16:29:46 1/1
Jane Doe, NoID						
	Measurements			Mean	GA	EDC
BPD - Campbell	80.4 mm	75.0 mm	78.9 mm	78.1 mm	30w 0d	13-01-2010
AC - Campbell	250 mm	258 mm	248 mm	252 mm	29w 2d	18-01-2010
FL - Campbell	57.1 mm	57.2 mm	57.4 mm	57.2 mm	30w 1d	12-01-2010
	Clinical	Ultrasound				
GA:				29w 6d		
EDC:				14-01-2010		
	Other Measurements			Mean		
APD	109 mm		72.0 mm	72.7 mm		84.6 mm
ATD	49.6 mm		92.1 mm	85.0 mm		75.6 mm
Remarks:						

Figure 6-6. An OB report.

The contents of the report will vary, depending on the Pro Package and the measurements you have made.

If the report has more than one page, click **Previous Page** and **Next Page** to navigate through the pages.

Patient comments are included in a report. You can also add additional remarks.

To add a remark to a report:

- Type in the **Remarks** area.

Adding Images to a Report

You can set up your system so that you can add all images to a report or only images that you select to be included. The **Miscellaneous System Setup** window is described on page 262.

To add all images to a report:

- 1 In the **Miscellaneous System Setup** window, check **Include All Images in Report**.
- 2 Start the exam and save images, clips, etc.
- 3 On the **Documentation** tab, click **Report**.
All 2D images (but not clips, 3D images or reports) are added to the report.

To add selected images to a report:

- 1 In the **Miscellaneous System Setup** window, uncheck **Include All Images in Report**.
- 2 Start the exam and save images, clips, etc.
- 3 Select some of the thumbnail images.
- 4 On the **Documentation** tab, click **Report**.

The selected 2D images (but not clips, 3D images or reports) are added to the report.

Comments put in the **Patient** window appear in the report.

You can type in up to 4 lines of remarks on the first page of the report.

Editing a Report

You can edit a report before you save it.

To delete a measurement from a report:

- 1 Point at the measurement result in the **Measurements** column.
If the measurement is one that can be deleted, the measurement value is highlighted in red and crossed out.
- 2 Click.
The measurement is removed from the report.

Printing a Report

To print a report:

- Press the **Print** key.
The current page of the report is printed. If the report has more than one page, click **Next Page** or **Previous Page** to view other pages of the report and print them.

NOTE: Reports can be saved as documents or captured as images but cannot be printed directly from the thumbnails. In either case, open the thumbnail to print from the monitor.

Saving a Report to the Local Patient Archiving System

To save the report to the local patient archiving system:

- Click **Save** on the report.

Printing Documents or Images on the Monitor

You can print documents on a local printer or, if DICOM is installed on your system, send them to be printed on a DICOM printer. You can also set up an office printer on a network.

You cannot use an office printer directly with the USB connector on the system. The only printers you can connect directly to the system are ones listed as approved in the Product Data information. See also the Safety chapter in the *bk3000 & bk5000 User Guide*.



Caution Print-c1

The quality of a printed ultrasound image may vary, depending on the printer.

Printing Thumbnail Images

To print thumbnail images (including archived ones) without opening them:

- 1 Click the thumbnails you want to print (to select them).
- 2 On the **Documentation** tab, click **Print**.
- 3 Click the printer you want on the drop-down menu that appears.
The images are printed.

To open a thumbnail image and then print it:

- 1 Double-click the thumbnail image to open it.
- 2 On the **Measure and Mark** tab, click **Print**.
The default setting is for a black and white USB printer.

To set a different printer as default for the Print screen key:

- 1 Press **Fn+C** on the keyboard.
- 2 Click the little circle that appears on the top left corner of the **Print** screen key.
- 3 Scroll through the list that appears and click the printer you want.
- 4 Click the **x** in the top right corner of the list menu to close the menu and save your changes.

See Appendix E, “Configuring the bk3000 and bk5000” for more details.

Printing Images Displayed on the Monitor

To print an image displayed on the monitor:

- Press the **Print** key on the keyboard.

You can customize how the Print key works.

To specify which printer the key will print to:

- 1 Make sure the image is not frozen.
- 2 Click **Advanced**, then **Customize**.
- 3 Click the **Keys/Menus** tab and in the **Assignments** pane in the window, find **Print**.
- 4 Click **Print** and select a printer in the drop-down menu that appears.

A change in key assignment only affects the particular Pro Package that is selected in the left pane on the tab.

Using a Transducer Button

You can set up a transducer button as a user-defined key for printing. See “User-Defined Keys” starting on page 247.

Chapter 7

Imaging Modes

Imaging Modes

The bk3000 and bk5000 have various imaging modes.

Screen controls associated with an imaging mode are on the **Image** workflow tabs. The **Image** tab is divided into subtabs corresponding to the imaging modes. See “The Image Tab” on page 18.

- B-mode gives real-time 2D information about the anatomical structure of soft tissues. Includes tissue harmonic imaging. B-mode controls are on the **General** subtab of the **Image** tab.
- Color mode (CFM, color flow mapping, color Doppler) ultrasound displays color-coded, real-time information about direction and velocity of flow in the tissues.
- Power mode (power Doppler) ultrasound displays information about the number of particles moving, rather than their velocity. Power mode controls are on the **Color** subtab of the **Image** tab because Color and Power modes are considered different types of Color mode.
- Doppler mode (spectral Doppler mode) imaging displays information about the spectrum of flow velocities as a function of time. Doppler mode controls are on the **Doppler** subtab of the **Image** tab.
- Continuous wave Doppler¹ (CW Doppler) imaging is used to detect very high velocities in cardiac/echocardiography.
- M-mode (motion mode) ultrasound is produced by slowly sweeping one line of a B-mode image across the monitor. The M-mode image illustrates a time series of images along this line.

NOTE: *You cannot change imaging modes when the image is frozen.*

Adjusting the Thermal Index Limit

Before you use the system, check that the TI settings are appropriate. The current TI tissue type and limit are displayed on the right side of the monitor, under the image area.

The absolute TI limit for each tissue type is set by the factory to conform to FDA guidelines and international standards (AIUM/NEMA and IEC) (see the acoustic output section in the *bk3000 & bk5000 User Guide*), but you may want to set a lower TI limit for some purposes. There are 2 types of settings you can vary:

- Tissue type (TIS – soft tissue, TIC – cranial, TIB – bone)
- TI limit (not exceeding the factory-set limits)

1. CW Doppler imaging on the bk3000 and bk5000 has not been licensed by Health Canada.

To select tissue type:

- Click the **TI** type displayed and select **TIB**, **TIC**, or **TIS**.
or
- Press the **+/-** key to toggle through the settings.

To adjust the TI limit:

- Click the limit displayed after the TI type and select the value you want.
The current TI is displayed as **TIx:z.z<y.y**, where x is S, C, or B; y.y is the limit you select; and z.z is the actual TI.

B-Mode

Focus

The ultrasound image is focused sharply within a selected zone, while the rest of the image is not as well focused. The bk3000 and bk5000 can use either a single focal zone or multiple (up to 3) focal zones (multiple focusing).

When more than one focal zone is active, ultrasound beams are focused at different depths in the tissue. This improves the focus in several zones. However, using more focal zones gives a lower frame rate. Thus using multiple focal zones when there is much tissue movement causes the image to be blurred.

The **Focus** indicator to the left of the image shows the extent (range) of the focal region as well as the point of best focus.

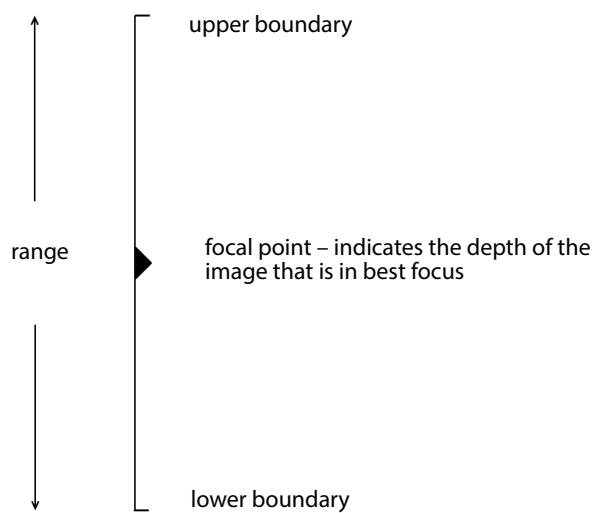

Figure 7-1. The Focus indicator.

The focal point triangle indicates the depth of the image that is in best focus – the focal point. If there is more than one focal point the range automatically expands to display the improved range of focusing. The actual number of focus zones is not shown.

You can adjust both the position and range of the area in best focus.

To adjust focus position:

To move the focus up or down on the image, select the focus indicator and drag it vertically to the desired position on the image.

- 1 Select the **Focus** indicator by clicking on it or pressing the **Focus** key.
- 2 Drag the **Focus** indicator to the desired position.
- 3 Click.

B Focus Range

You adjust the focus range by clicking the **B Focus Range** screen key:

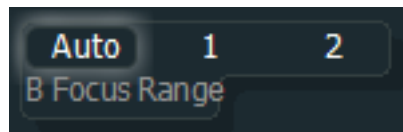

Select **1** for one focus zone and **2** for two focus zones, which will give you a larger focus range than **1**. Selecting **Auto** will let AMA (Automatic Mode Adjustment) control the focus zones based on transducer type and selected **Res/Hz** setting. Default value for **B Focus Range** is **Auto**.

Note: In some cases multiple focus zones are not supported. In this case, the B-focus range screen key is inactive.

Tru-Focus

Selected transducers are equipped with Tru-Focus¹. This focus enhancement gives you full focus in the entire depth of the image. With Tru-Focus, it is not possible to further adjust the focus position.

Gain

You can control the overall gain of an imaging mode by turning the mode key or by clicking **Gain** on the **Image** tab.

TGC

The TGC (Time Gain Compensation) curve determines variable amplification applied to echoes from different depths in the tissue. The TGC function compensates for attenuation and scattering of the ultrasound beam in the tissue.

When you select a transducer, if all TGC sliders are in the center position, imaging starts using a default TGC curve optimized for the transducer. (The default is either the one set at the factory or one you have set up yourself.)

1. bk5000 only.

The **TGC** sliders adjust the relative gain of the image at different tissue depths. Each slider adjusts a specific part (1/8th) of the TGC curve; the topmost control adjusts the top 1/8th of the image.

NOTE: *The sliders operate relative to their center position; when they are all centered, the default TGC is used.*

However, resetting the gain to the default setting may change the relationship between the TGC sliders and the TGC curve.

To adjust the TGC curve:

- Move the **TGC** sliders to the right or left to adjust the TGC curve.

The shape of the TGC curve is temporarily displayed to the right of the image as a curved vertical line. This indicates the modification that is applied to the default TGC curve.

NOTE: *The TGC curve operates on the monitor image, not on the ultrasound echo. Therefore, if you move or resize the image, you may have to readjust the TGC curve.*

NOTE: *With 360° transducers, the top slider adjusts the part of the image that is most central – that is, closest to the transducer.*

Auto Gain

You can also choose to use Auto gain. With Auto gain, a selected preset defines the brightness for this particular type of scan (also depending on the transducer). Auto gain makes it possible to have the same brightness across different patients and body parts.

To activate Auto gain:

- Long-press the **Auto** button,

or

- Click the **AutoGain** screen key on the right side of the screen and use +/- to toggle between on and off.

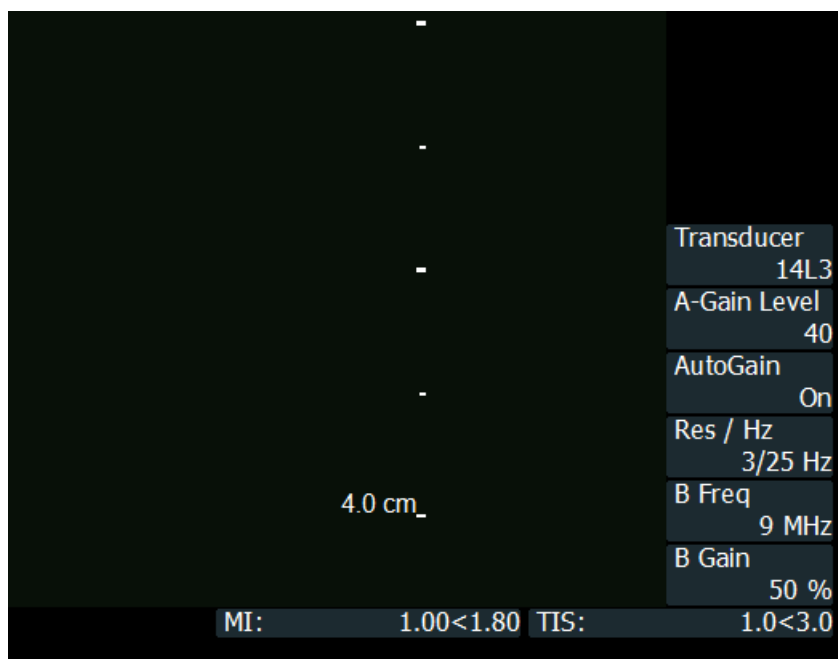

Figure 7-2. Auto gain info on the right of the screen.

To adjust the brightness/strength of Auto gain, click **A-Gain Level** to the right of the screen and use +/- on the keyboard to increase or decrease the strength.

NOTE: Adjustment here will result in a new default for all patients/body parts.

Settings

It is possible to select between 4 settings of Auto gain. Two of these are fully automatic, two of them manual and require a click on the **Auto** button each time you want to optimize the image:

AutoGain settings:

- 1 **Auto-Axial**- This setting equalizes the gain automatically and continuously during scanning. The gain will be equalized in depth (i.e. axially) and the overall gain will be adjusted.
- 2 **Man-Axial** - In this setting, the gain will be adjusted to the current image when you click the **Auto** button. The gain will be equalized in depth (i.e. axially) and the overall gain will be adjusted.
- 3 **Man-All** - In this setting, the gain will be adjusted to the current image when you click the **Auto** button. The gain will be equalized in depth (i.e. axially) and across the image, and the overall gain will be adjusted.
- 4 **Auto-All** - This setting equalizes the gain automatically and continuously during scanning. The gain will be equalized in depth (i.e. axially) and across the image, and the overall gain will be adjusted.

You select Auto gain setting by clicking the **Auto Mode** screen key:

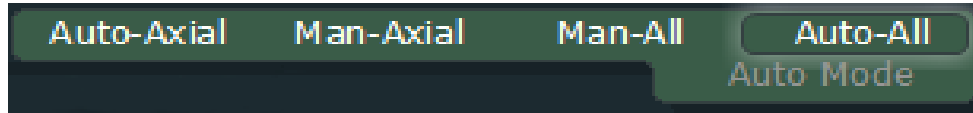

Figure 7-3. The Auto Mode screen key with the different setting options.

NOTE: You can configure the control button on the transducer to the same function as the *Auto* button.

Zoom

To zoom in or out on the area you are interested in, adjust the Zoom box and then make the part of the image that is inside the box fill the monitor.

NOTE: To zoom in on a small part of the image, make the box smaller.

To use the Zoom box (zoom on different parts of the image):

- To move the Zoom box, select it and drag it.
- To resize the box (zoom in or out), turn the \mathcal{Q} key or press +/- when the box is selected.

You can also resize the box by clicking one of the corners and then dragging the corner or using the +/- key.

To return to the original image:

- Press \mathcal{Q} .

Pressing the \mathcal{Q} key	Does this	You can
First press	Turns on the Zoom box and selects it. You can move (drag) it or resize it.	Turn \mathcal{Q} key to change the size of the Zoom box. Use trackball to move it (drag) or resize it (+/- key).
Second press	Makes the contents of the (selected) Zoom box fill the entire monitor.	Press \mathcal{Q} to return to the previous image.
Third press	Returns image to the state it was in before the first press.	
Long press	Turns off the Zoom box.	

Table 7-1. Overview of the Zoom key.

Depth

With a full B-mode image, you adjust the depth to cut out parts below the part you are interested in. The image always includes the transducer surface, so this key changes the magnification of the image, stretching, or compressing it.

NOTE: To adjust the depth of the image without changing the magnification, you can pan the image. When the image is panned, the top of the image does not necessarily still correspond to the transducer surface.

Adjusting the depth of a zoomed image changes the magnification even though the transducer surface is not necessarily visible at the top of the image.

To adjust the depth:

- On the Image tab, click **Depth +** or **Depth -**.
- Place the cursor in the image field and press the **+/-** key on the keyboard.
or
- Turn the  key when the Zoom function is turned off.

Gray Scales

Several gray scales can be used to display a B-mode image or an M-mode image. Different gray scales may make various aspects of the image clearer.

To select the gray scale in B-mode:

- 1 Point at the upper right of the image area.
A gray scale bar appears.
- 2 Click the gray scale bar and select the gray scale you want.

To select the gray scale in M-mode:

- Click the gray scale bar to the right of the M-mode image and select the gray scale you want or point at the color bar and press **+/-**.

NOTE: *When you image in Color or Power mode, you cannot use the color bar to change the B-mode gray scale because it is used to control the color mapping.*

Combination Modes

B-mode can be used in combination with other modes. (The terms *duplex* and *triplex* imaging refer to combinations of 2 or 3 modes.)

The available combinations are:

- B+Color
- B+Doppler
- B + M
- B+Color+Doppler
- B+Power
- B+Power+Doppler

To return to imaging with B-mode alone after you have been using it in combination with other modes, press the **B-Mode** key.

To add another imaging mode:

- Press the **Color Mode**, **Power Mode**, or **Doppler Mode** key, or click the tab for the imaging mode. (To add M-mode, you must click the **M-Mode** tab on the monitor).

To remove an imaging mode from the combination:

- Press the key for the mode you want to remove. You can also click the imaging mode tab when it is on top (This is the only way to turn off M-mode).

To return from a combined mode to B-mode only:

- Press the **B-Mode** key.

NOTE: Pressing the **B-Mode** key several times lets you toggle back and forth between B-mode and any combined mode.

Tissue Harmonic Imaging (True Echo Harmonics – TEH)

Tissue harmonic imaging can reduce noise and improve the clarity of the ultrasound image.

In normal B-mode imaging, the transducer uses essentially the same frequency range for both transmitting and receiving. In harmonic imaging, the image is created by receiving higher frequencies (harmonics) that are multiples of the transmitted frequency (f). Tissue harmonic imaging in the bk3000 and bk5000 is based on the 2nd harmonic ($2f$) spectrum and pulse inversion.

Using TEH

TEH can be used only with transducers that support harmonic imaging.

Each preset that permits TEH has default settings for overall gain, TGC gain, contour level, and contrast level for tissue harmonic imaging.

Restrictions

- TEH is available for B-mode imaging only. If more than one imaging mode is active, TEH will be disabled.
- TEH is available only for certain transducers.

Advantages

- Better images with difficult-to-image patients.
- Increased contrast resolution.
- Reduced effect of grating lobes.

Limitations

- Best in mid-range depth – the specific depth range for which harmonic imaging works best depends on the transducer as well as other factors.
- Reduced penetration.
- Reduced lateral resolution.
- Reduced frame rate.

To turn TEH on or off:

Make sure that you are imaging in B-mode (imaging is not frozen).

- Press the **Harmonic** key or click **Harmonic** on the **Image** tab.

When you turn harmonic imaging off, B-mode imaging resumes with the frequency, gain, dynamic range etc. that you were using previously.

Displayed Frequencies for Tissue Harmonic Imaging

When TEH is turned on, the letter **H** appears next to the displayed frequency, which is the receiving frequency – double the transmitted frequency.

Contrast Imaging

In contrast imaging¹, a contrast agent consisting of microbubbles is injected into the patient. When the ultrasound waves are reflected from the contrast agent, non-linear responses are generated. The non-linear signals are received and analyzed to create the contrast image.

Contrast imaging requires a software license from BK Medical and is available with the following transducers²:

For bk3000:	For bk5000:
• 5C1e	• 5C1e
• 6C2	• 6C2
• 6C2s	• 6C2s
• 8L2	• 8L2
• E14CL4b	• E14CL4b
• E14C4t	• E14C4t
	• I14C5I
	• I14C5T
	• I12C5b
	• I12C4f
	• X12C4

Contrast Agents

Contrast imaging is optimized for SonoVue® and DEFINITY® contrast agents. You must follow the manufacturer's guidelines for using contrast agents and pay attention to any warnings, recommended precautions and contraindications.

1. Contrast Imaging on the bk3000 and bk5000 has not been licensed by Health Canada.
2. Transducers 5C1e, 8L2, I14C5I, I14C5T, I12C5b, I12C4f and X12C4 have not been licensed by Health Canada.

Restrictions

Contrast imaging can be used only with:

- B-mode imaging. If another imaging mode is active, contrast imaging is disabled.
- The transducers mentioned above.

Simultaneous Split-Screen Imaging and Contrast Imaging

It can be an advantage to use simultaneous split-screen imaging (see “Simultaneous Imaging” on page 30) with contrast so that you can see a contrast image that contains no tissue information along with a B-mode image.

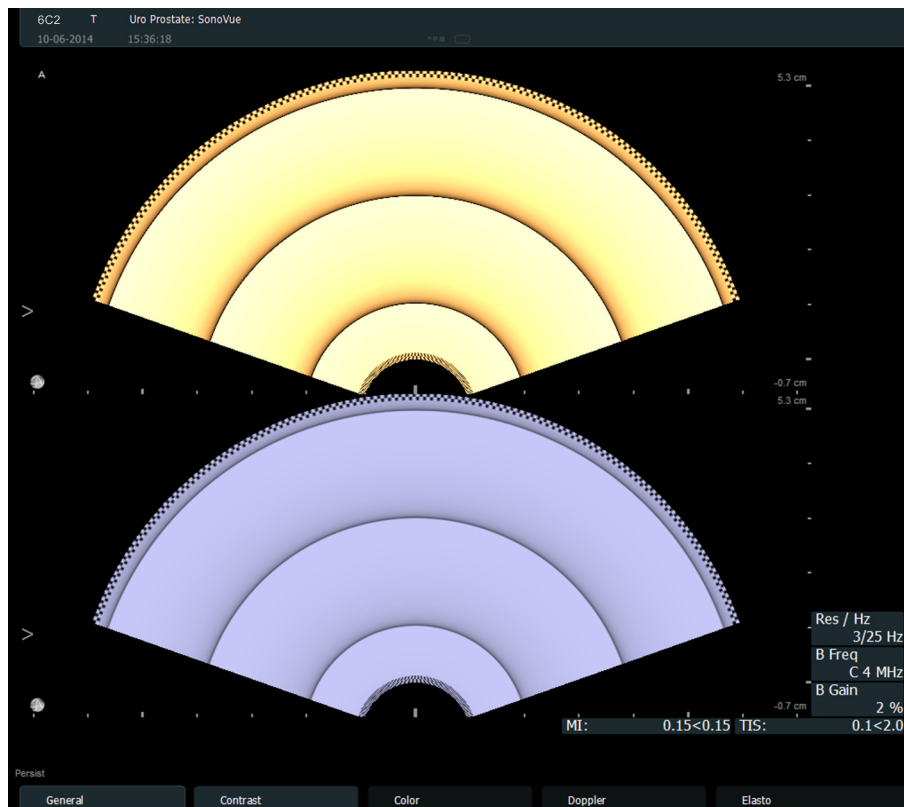

Figure 7-4. Contrast imaging with split screen.

To turn contrast imaging on:

- Click on the **Contrast** tab.

It is also possible to configure a key to enable and disable contrast imaging. See “Setting Up and Customizing Your System” on page 245.

When contrast imaging is turned on, the letter **C** appears next to the frequency at the top of the monitor. Contrast imaging appears in simultaneous split mode, with contrast imaging in screen A and B-mode in screen B.

To turn contrast imaging off:

Make sure that you are imaging.

- Click on the **Contrast** tab.

or

- Press **[B]**.

NOTE: When you turn contrast imaging off, the MI returns to its previous value.

To use contrast imaging:

- 1 Make sure that you have a license for contrast imaging. See “Licenses” on page 282.
- 2 Click **Setup** at the top of the monitor.
The **Pro Package Menu** window appears (see “Pro Packages” on page 111.)
- 3 Use B-mode imaging to locate the lesion and prepare for contrast imaging.
- 4 Click on the **Contrast** tab.
The contrast frequency is displayed at the top of the monitor, preceded by **C**.
- 5 Inject the contrast agent and start the timer. (See “Timer” below.)
- 6 Check the MI setting. When you turn on contrast imaging, the MI limit is reduced to avoid bursting the bubbles in the contrast agent. You can turn **[Doppler Gain]** or click **MI** to make small changes to the setting in order to make it suitable for the type of tissue and depth of the region of interest. (See “Adjusting MI” on page 105.)
- 7 Click **Capture Clip** or **Capture Image** to save clips or images to the patient archiving system so you can review them later.
- 8 If you want to inject more contrast agent, you can burst the remaining bubbles first. (See “Bubble Burst” on page 83.)

Timer

You can start the timer to keep track of the elapsed time after you inject a contrast agent. The time will be displayed on a saved or printed image.

NOTE: *The timer is always available - not just with contrast imaging.*

To start the timer:

- Click **Timer** or press a user-defined key.
The timer starts running and the elapsed time replaces the word “**Timer**”.
The elapsed time is also displayed in the image area of the monitor. This time is saved when you save or print the image. You can move the time to a new location on the image by clicking and dragging it.

NOTE: *When you freeze the image, the time on the image is frozen. When you unfreeze the image, the time on the image is updated to be correct.*

To stop the timer:

- Click **Timer**.
The time value in the image area disappears.

Bubble Burst

When you use the **Bubble Burst** function, a stronger ultrasound pulse is emitted to burst the remaining bubbles so that you can inject additional contrast agent to repeat the examination.

To use Bubble Burst:

- Click **Bubble Burst** at the bottom of the monitor or press a user-defined key.

 <p>High acoustic output during Bubble Burst</p>	<p>Caution Exam-w6</p> <p>When you turn on Bubble Burst, the acoustic output limits are increased to 1.9 (MI). This change overrides any limits you have set. During Bubble Burst, the acoustic output will exceed normal contrast imaging values and may approach the higher (Bubble Burst) limits.</p>
---	---

X-Shine

X-Shine uses an adjustment of ACI (Angular Compound Imaging) plus improved focusing to help the user visualize the needle during interventional procedures. A needle icon indicates where you will get the best visibility.

	<p>WARNING GS-w1</p> <p>Before you attempt to use BK Medical equipment, you should be trained in ultrasonography or be under the supervision of someone who is trained in ultrasonography. You should also be thoroughly familiar with the safe operation of your ultrasound system: read all the user documentation that accompanies it.</p> <p>In addition, if your system interacts with other equipment directly or indirectly, you need to be trained in making sure the interactions are both safe and secure.</p> <p>No further training is required, but BK offers training in how to use the system. Consult your BK representative for information.</p>
---	--

	<p>WARNING P-w4</p> <p>The puncture line on the image is an indication of the expected needle path. To avoid harming the patient, the needle tip echo should be monitored at all times so any deviation from the desired path can be corrected.</p>
---	--

X-Shine is available as an option (license).

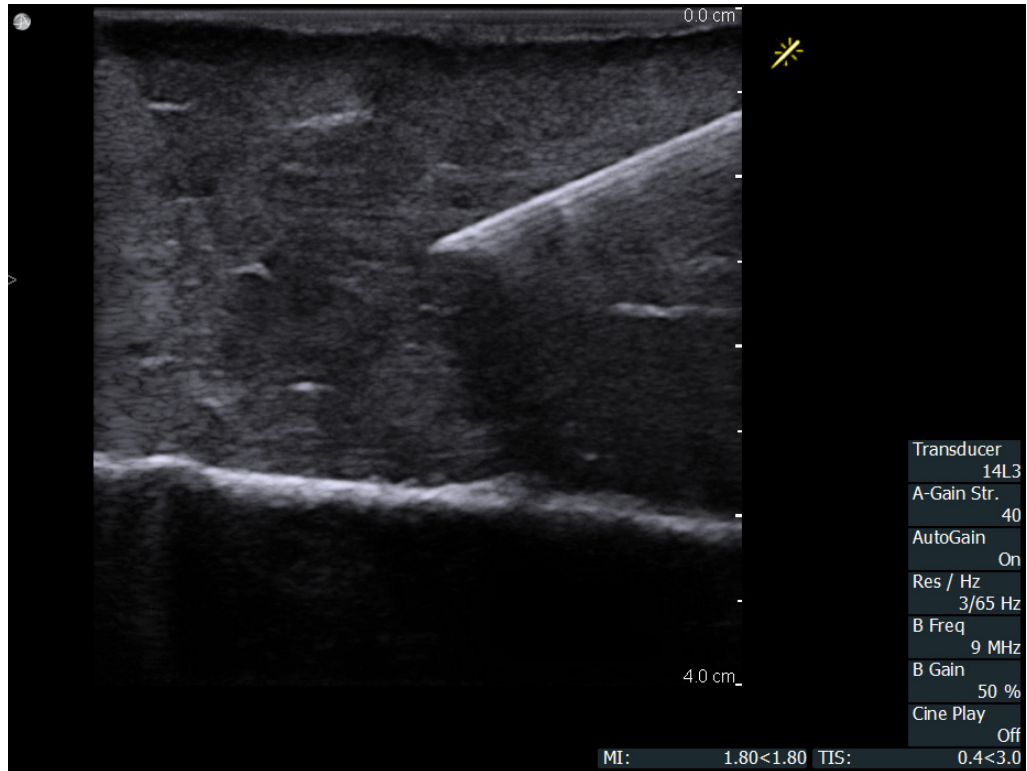



Figure 7-5. Image showing the X-shine icon and inserted needle

In B-mode, you can access X-Shine on the keyboard (using the **Steer**  button) or add buttons on the screen using **fn + C**.

All controls function in the same way and cycle through 3 stages:

- **On+**
- **On-**
- **Off**

On+ and **On-** switches sides on the image and **Off** returns you to default B-mode image quality.

Activate X-Shine Imaging

Do as follows:

- 1 Ensure that **B-mode** is active.
- 2 Cycle the **On+**, **On-** and **Off** states on the **X-Shine** button  on the keyboard or use your selected screen key.

NOTE: Make sure that you adjust the icon  to match your needle insertion side.

- 3 If needed, for example in steep needle angles, you can adjust the balance between the needle strength echo and image quality. For this, use the **Needle Strength** screen key. Increase the number to increase the needle shaft visibility. Decrease the number to improve image quality over needle visualization.

Use the **Needle Strength** slider (Fig 7-6) if you prefer to adjust the balance using the trackball, or the **Needle Strength** toggle (Fig 7-7) if you prefer to adjust the balance by clicking the screen key.

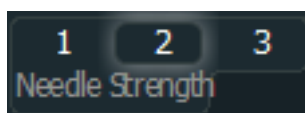

Figure 7-6. Needle strength slider

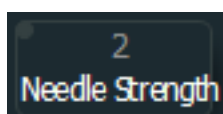

Figure 7-7. Needle strength toggle screen key

Note that the **Needle Strength** screen key will only be active when X-Shine is on.

Adding Buttons to the Screen

You can add the X-Shine keys to the monitor controls on the screen. Select your preferred X-Shine screen key and also add the Needle Strength slider or toggle to improve needle visibility:

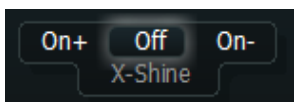

Figure 7-8. X-Shine slider.

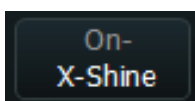

Figure 7-9. X-Shine toggle.

To make a new screen key:

- 1 Press **Fn+C** and click on available space (one with little circles).



- 2 Select the key name (for example, **Labels clear all**) from the drop-down list that appears.
- 3 Press **Fn+C** to save your new configuration and leave Configuration Mode.

Color Mode and Power Mode

Color mode (CFM, color flow mapping, color Doppler) ultrasound displays color-coded real-time information about direction and velocity of flow in the tissues.

Power mode displays color-coded information about the amount of flow but not the direction.

Color Submodes

On the **Color Image** tab, you can select the submode you want. The view must be imaging when you do this.

Three submodes are available in Color mode imaging:

- **Velocity** (standard color mode)¹
- **VFI²** (See “Vector Flow Imaging (VFI)” on page 92)¹
- **Tru-Color**. Tru-Color is an alternative to normal color mode without the persist function. It has less averaging and is therefore able to maintain a significantly higher temporal resolution. In this way, you can more easily visualize the hemodynamics, including differences between systole and diastole.³

One submode is available in Power mode imaging:

- Power (power Doppler).

Color Coding of Flow

In a Color mode image, the frequencies of the reflected ultrasound waves are measured to show the velocity and direction of the blood flow. The result is displayed in color on the monitor.

1. bk3000 and bk5000.

2. Vector Flow Imaging on the bk5000 has not been licensed by Health Canada.

3. bk5000 only.

Flow Direction	Default Color
Toward the transducer	Red
Away from the transducer	Blue

Table 7-2. Default color coding in Color mode.

It is possible to invert this color-coding or select a different one.

Independent D-Mode/C-Mode Steering

Independent steering of PW Doppler and CFM is possible using the **Sync Steer** screen key. To enable independent steering, click **Sync Steer** under the advanced **Doppler** tab and switch the setting to **Off**.

NOTE: *This feature is only available for certain transducers and pro packages.*

Color Box

When Color mode or Power mode imaging is turned on, a color box is superimposed on the B-mode image. The color box outlines the area of the tissue in which flow information is available.

You can adjust the size and position of the color box to examine flow in various parts of the B-mode image. The view must be imaging when you do this.

To resize the color box:

- 1 Point at the box or select it by clicking inside it or pressing the **Color Box** key.
- 2 Press +/-.

or

- Click a corner of the box and drag the corner.

To move the color box:

- Click inside the box and drag the box.

Color Scales

Various color scales can be used to display a Color mode or Power mode image or a Doppler spectrum.

To select the color scale:

- Click the color bar to the right of the image and select the color scale you want.

NOTE: *When you image in Color or Power mode, you cannot use the color bar to change the B-mode gray scale because it is used to control the color mapping.*

Elastography

Elastography is a medical imaging mode using manual tissue compression or motion from e.g. patient cardiac movement or respiration, in order to evaluate tissue stiffness. Elastography requires a software license from BK Medical and is available with the following transducers¹:

For bk3000:	For bk5000:
• 5C1e	• 5C1e
• 9C2	• 9C2
• 14L3	• 14L3
• 13L4w	• 13L4w
• 10L2w	• 10L2w
• 18L5	• 18L5
• 18L5s	• 18L5s
• 8L2	• 8L2
• E14C4t	• E14C4t
• E14C4	• E14C4
• E14CL4b	• E14CL4b
• E10C4	• E10C4
• E13C2	• E13C2
• N13C5	• N13C5
• X18L5s	• X18L5s
	• I14C5I
	• I14C5T
	• I12C5b
	• I12C4f
	• N11C5s
	• X12C4

1. Transducers 5C1e, 8L2, 9C2, 18L5s, E13C2, E14C4, I14C5I, I14C5T, I12C5b, I12C4f, X12C4, X18L5s have not been licensed by Health Canada.

Before using elastography, you should be adequately trained in ultrasonography.

 <p>Proper Training</p>	<p>WARNING GS-w1</p> <p>Before you attempt to use BK Medical equipment, you should be trained in ultrasonography or be under the supervision of someone who is trained in ultrasonography. You should also be thoroughly familiar with the safe operation of your ultrasound system: read all the user documentation that accompanies it.</p> <p>No further training is required, but BK Medical offers training in how to use the system. Consult your BK Medical representative for information.</p>
--	---

To activate elastography mode:

- On the **Image** tab, click **Elasto**.

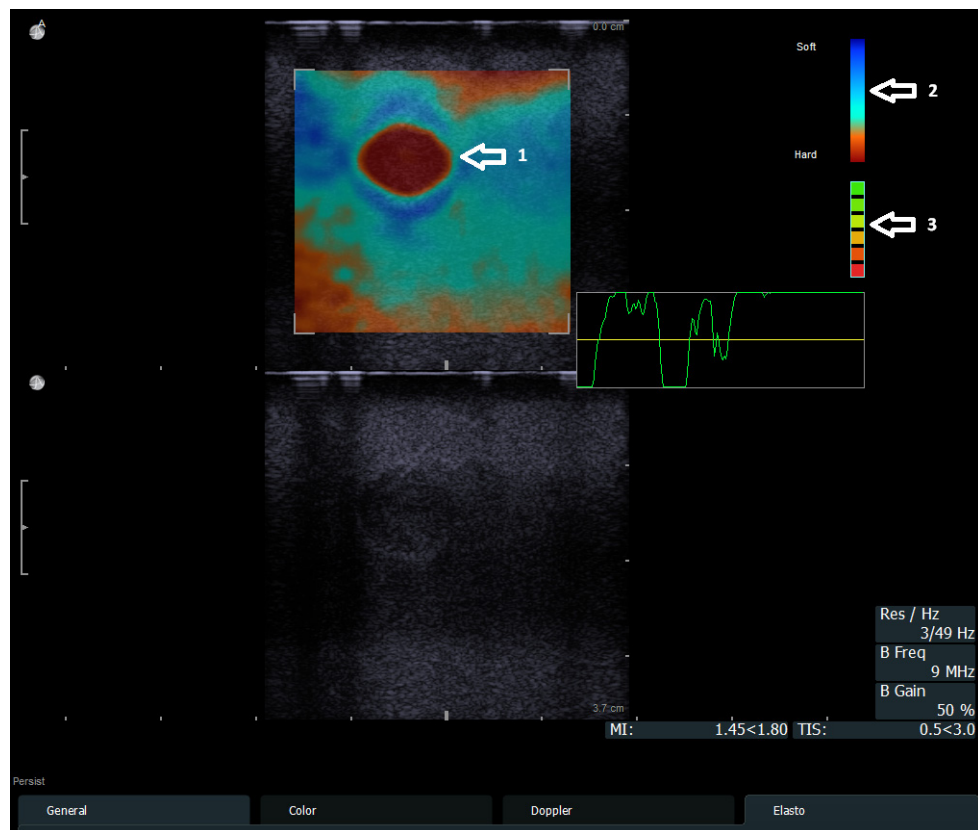

Figure 7-10. Elastography imaging (default horizontal view).

- 1 Region of interest (ROI)
- 2 Color Map
- 3 Quality Indicator

Color Box

When elastography mode imaging is turned on, a color box is superimposed on the B-mode image. The color box outlines the area of the tissue in which information is available.

You can adjust the size and position of the color box to examine various parts of the B-mode image. The view must be imaging when you do this.

To resize the color box:

- 1 Point at the box or select it by clicking inside it or pressing the **Color Box** key.
- 2 Press +/-.

or

- Click a corner of the box and drag the corner.

To move the color box:

Click inside the box and drag the box.

Color Map

The color map represents the variants in levels of relative hardness/softness. The default setting is red = hard, and blue = soft. If you click on the color map, you can choose from a set of different color codes.

Quality Indicator

The quality indicator displays the amount of pressure being placed on the transducer. If the green indicator is at the top, transducer compression is at the optimum level and the amount of noise is at an acceptable level for image acquisition.

Strain Ratio Measurement

Strain ratio measurements can be used to quantify the relative stiffness between the region of interest (ROI) and the surrounding tissue. To perform a strain ratio measurement:

- 1 Click the **Elastography** tab, click **Image** and then **Strain Ratio**.
- 2 Click inside the ROI and then move the trackball to create a measurement circle. When the circle is the required diameter, click again to set the measurement circle on the screen.
- 3 Repeat the measurement process outside the ROI.

The strain ratio appears under the image in a purple box. Note that the strain ratio is reported as an inverse value.

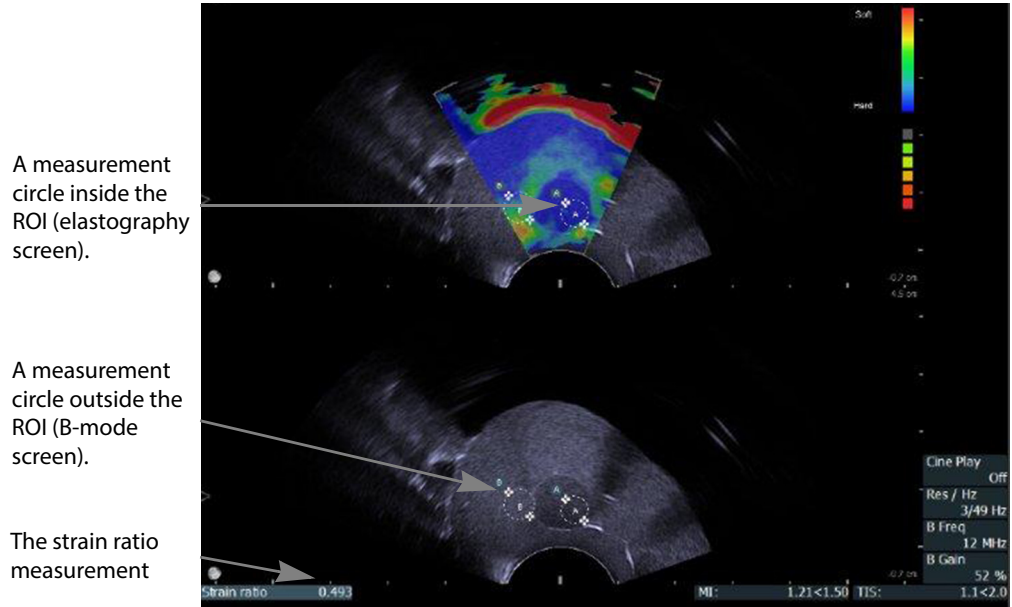

Figure 7-11. A strain ratio measurement.

Diameter Comparison Measurement

The elastography diameter of an ROI can be compared to the B-mode diameter.

- 1 Click the **Elastography** tab, and then click **E/B Diameter**.
- 2 Click on the edge of the ROI in the elastography screen and move the trackball to the opposite side of the ROI. Click again to place an E-diameter line.
- 3 Repeat the measurement process in the B-mode screen to place a B-diameter line.

The E- over B-diameter measurement appears under the image in a purple box.

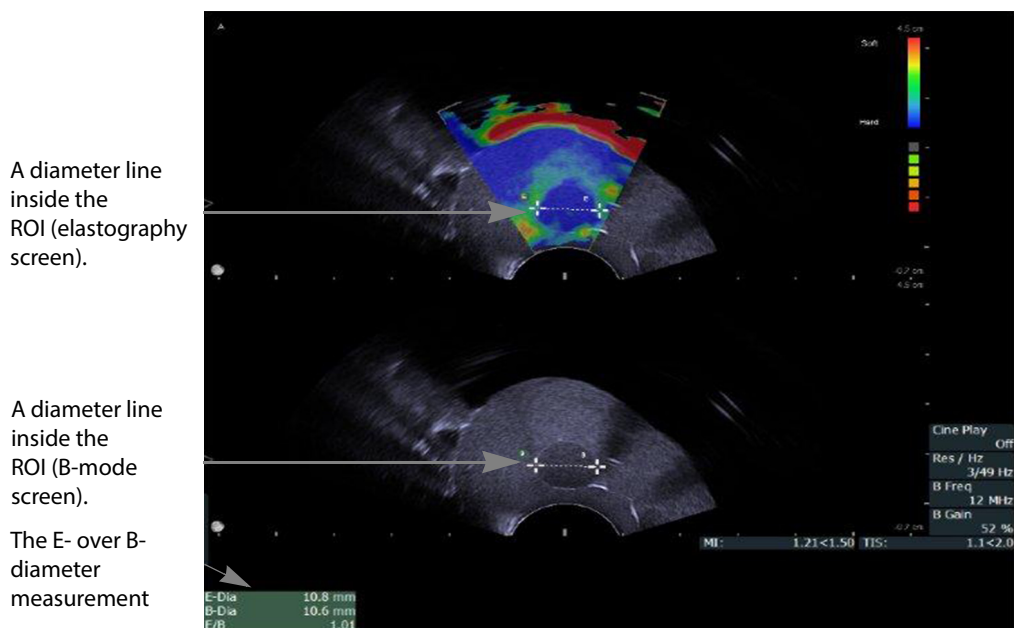

Figure 7-12. A diameter comparison measurement.

Vector Flow Imaging (VFI)

Vector Flow Imaging¹ is available as an option on the bk3000 and bk5000 ultrasound systems.

Normally, color imaging shows only axial flows. Vector Flow Imaging is a technology that uses ultrasound pulses in both axial and lateral directions. The measured signals are therefore sensitive to both axial and transverse motion.

VFI requires a software license from BK Medical and is available with the following transducers²:

Transducer	Recommended max. depth of using VFI bk3000	Recommended max. depth of using VFI bk5000
6C2	60 mm	60 mm
14L3	30 mm	35 mm
10L2w	30 mm	40-50 mm
8L2	40 mm	50 mm

VFI can be useful for the visualizing the following with high sensitivity:

- Flow when the transducer is perpendicular to the vessel – flow visualization that is independent of imaging angle.
- Carotid and other vessels with high or complex flow.

NOTE: *Vector Flow Imaging is only available with certain transducers and certain Pro Packages and presets.*

Vector Flow Imaging can be used in the velocity range of 10 cm/s to 315 cm/s with the corresponding PRF.

Using auto-correlation estimators, both the axial and transverse velocity components are determined and used to make an estimate of 2D blood velocity that does not depend on the image angle.

This method alleviates the problem of achieving a sufficient image angle and makes it possible to visualize complex flow patterns.

The maximum velocity that can be observed depends on the PRF. Higher velocities can be seen when the PRF is higher.

The direction and velocity of the flow are indicated on the image with color and also by arrows.

Color Flow Indicators for VFI – The Color Map

The **Color Map** is the default color flow indicator for interpreting the color. The **Color Map** outlines the maximum flow velocity by color. If you highlight the **Color Map** you can choose between 3 different VFI color options.

1. VFI on bk5000 has not been licensed by Health Canada.
2. The 8L2 transducer has not been licensed by Health Canada.

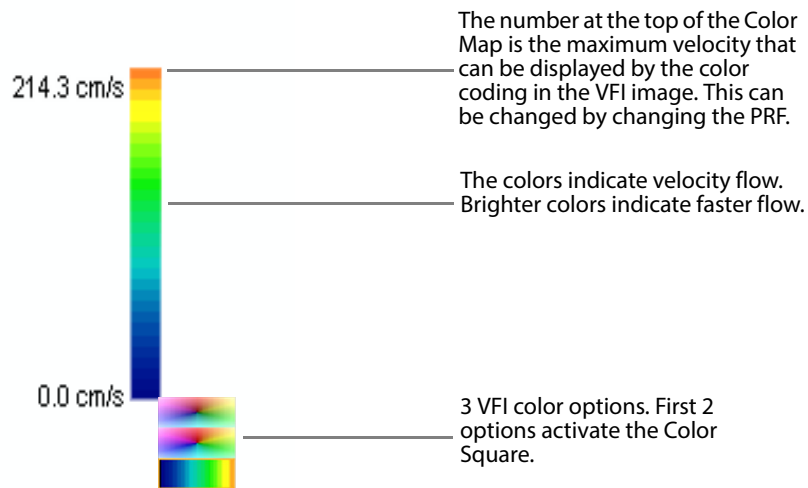

Figure 7-13. Explanation of the Color Map for Vector Flow Imaging.

Saturation/Brightness = Speed

Colors located nearer the top of the **Color Map** (less saturated colors) indicate faster flow.

Color Flow Indicators for VFI – The Color Square

The **Color Square** is an alternative to the **Color Map** for interpreting color. If you choose this color indicator, flow direction and velocity are mapped by color. You can move the **Color Square** around on the monitor (like a bodymark) so that it does not interfere with what you are trying to observe.

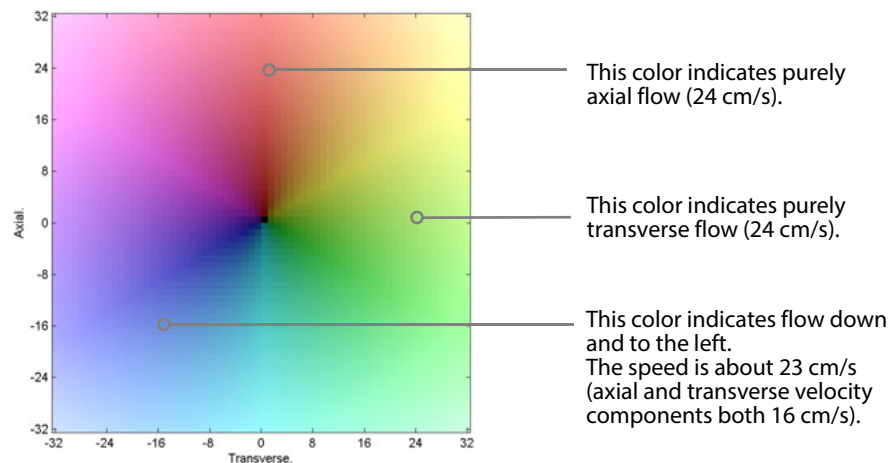

Figure 7-14. Explanation of the Color Square for Vector Flow Imaging. The values are only for illustrative purposes, as the color information is intended to be qualitative rather than quantitative.

Saturation/Brightness = Speed

The center of the square is black. Black indicates zero flow.

Colors located farther from the center (less saturated colors) indicate faster flow.

Color (Hue) = Direction

The color (hue) indicates the flow direction. For example, yellow indicates flow up and to the right.

Using VFI

VFI is activated by selecting an appropriate VFI preset. VFI presets are only available with the 14L3 and 10L2w transducers for bk3000 and transducers 6C2, 14L3, 10L2w and 8L2 transducers. You can choose from the **Carotid VFI** preset or the **Vein VFI** preset.

Alternatively, you can turn on VFI by:

- 1 Clicking Advanced on the Image tab.
- 2 Clicking the Color tab.
- 3 Clicking Submode and then VFI.

Steering of the color box is not possible when you use VFI



Figure 7-15. Selecting VFI submode.

Arrow Flow Indicators for VFI

Direction and relative velocity are also indicated by arrows superimposed on the flow part of the image. Longer arrows indicate higher velocity.

	<p>WARNING VFI-w1</p> <p>Before you turn on VFI, check the B-mode image to make sure there are no artifacts visible in the blood vessel. If there are strong artifacts in the B-mode image, the arrows in VFI may be pulled to point in a more axial direction (toward or away from the transducer), especially in low flow situations with correspondingly low PRF. These artifacts will not affect the color mode (CFM) image, so it is important to check in B-mode.</p>
--	--

Arrow Size (VFI)

Use **Arrow Size (VFI)** to adjust the space between the arrows and the size of the arrows in VFI mode. You can choose 3 different size settings (the default setting is Large):

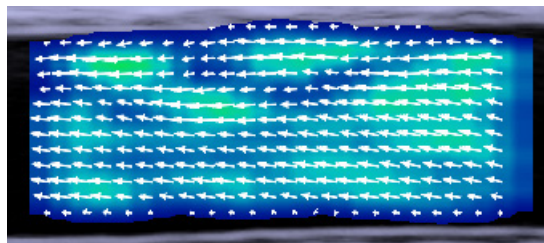

Figure 7-16. Small arrow size.

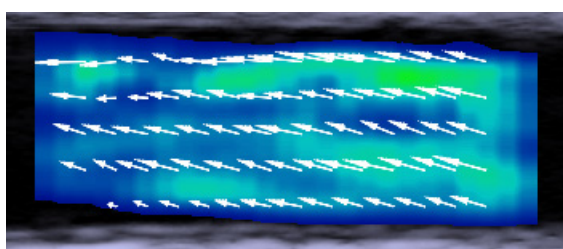

Figure 7-17. Medium arrow size.

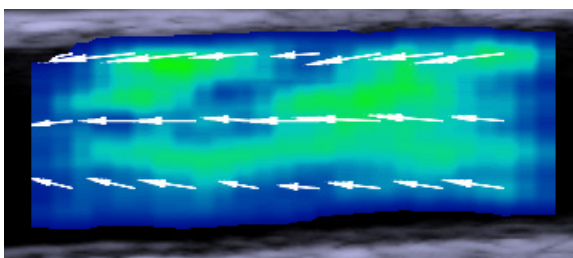

Figure 7-18. Large arrow size.

Streamlined VFI Workflow

VFI can be utilized to ease workload when determining peak systolic velocity or calculating volume flow rate.



In **B+VFI+D** mode, VFI can assist the user with:

- Doppler gate placement
- Angle correction
- Assisted Doppler steering
- Inverting the Doppler spectrum (when needed)
- Selecting the appropriate Scale/PRF (Pulse Repetition Frequency)
- Adaptively adjusting Doppler sample volume size (PW gate)
- Assisted Volume Flow Measurement

Assisted Doppler Gate Placement

Assisted Doppler gate placement is a method for selecting the optimal Doppler gate position when measuring the peak systolic velocity in arteries. The method uses VFI data to analyze where to place the Doppler gate at the highest velocity within the color box and the ROI (region of interest). The VFI data is also used to display and update flow direction, velocity, and Doppler in real-time.

To activate the assisted Doppler gate placement:

- Press **Doppler Mode**  if you are in B+VFI mode.
- or
- Press **Doppler Gate**  if you are in Triplex+VFI mode.

 Arrow aliasing	WARNING VFI-w2 Check to make sure the VFI arrows are not aliasing before you activate the assisted Doppler gate placement. Otherwise, the Doppler gate will not be positioned correctly.
---	--

Angle Correction

The angle of the flow at the position of the Doppler gate (selected either manually by the user or by the VFI data) is estimated and displayed in real-time. The estimated direction of the flow is indicated visually by the line passing through the Doppler gate (See Fig 7-20).

Assisted Doppler Steering

From the indication of the flow, the appropriate Doppler steering is selected using VFI data. Gate steering is updated dynamically. The steering angle corresponding to the angle of the flow is displayed in real-time, making it easier to monitor when the desired Doppler angle of 60° is achieved.

Inverting the Doppler Spectrum

Automatic inversion of the Doppler spectrum is activated when the gate steering changes from right to left.

Selecting the Appropriate Scale/PRF

If the manually specified Scale/PRF is too low or too high, it can be adjusted using VFI data.

To activate assisted Scale/PRF adjustment:

- Click **Auto Scale ON/OFF**: 

When assisted Scale/PRF adjustment is activated, enabling Doppler mode or pressing **Doppler Gate** will change the Scale/PRF based on the VFI data.

Pressing the **Doppler Gate** key will also adjust the Doppler baseline.

- If the initial Scale/PRF is far from correct, or the Doppler baseline is not adjusted correctly, it may be necessary to press **Doppler Gate** more than once.
- If the Doppler Gate adjustment is not satisfactory, you can revert to adjusting Scale/PRF and the Doppler baseline using **Auto**. This adjusts Scale/PRF (and Doppler baseline) using only the Doppler spectrum. However, this can cause the VFI signal to alias. Therefore, adjusting Scale/PRF using **Auto** should only be done when the Doppler gate is at the maximum velocity position.



Assisted Volume Flow Rate Estimation

Volume flow rate is an indication of the amount of blood that passes through a vessel over a specific time span, typically [ml/min]. Assisted volume flow rate estimation uses VFI data and Pulsed Wave Doppler (PWD) to calculate the volume flow rate in a vessel. Assisted volume flow rate estimation uses VFI data to outline the vessel and extend the Doppler gate to cover the entire vessel. Visual diameter markers are inserted for the user to inspect. If preferable, you can manually adjust the visual diameter markers.

To activate assisted volume flow rate estimation:

- Click **VF (real-time)**

The result of the assisted volume flow rate calculation is displayed in a real-time measurement value called VF.

 Diameter markers	<p>WARNING VFI-w3</p> <p>Check to make sure that the diameter markers correspond to the inner vessel wall and that the connecting line between the markers is perpendicular to the direction of the vessel. Otherwise, the real-time volume flow measurement may not be precise.</p>
 Doppler gate large enough	<p>WARNING VFI-w4</p> <p>Check to make sure that the Doppler gate covers the entire vessel. Otherwise, the realtime volume flow measurement may not be precise.</p>
 Doppler gate only over one vessel	<p>WARNING VFI-w5</p> <p>Check to make sure that the Doppler gate only covers one vessel. Otherwise, the real-time volume flow measurement may not be precise.</p>

Asymmetric Doppler Gate Cross

 <p>Doppler spectrum aliasing</p>	<p>WARNING VFI-w6</p> <p>Check to make sure that the Doppler spectrum does not alias. Otherwise, the real-time volume flow measurement may not be precise.</p>
--	---

The asymmetric Doppler gate cross places the POI (point of interest) at the highest velocity, and adjusts the Doppler gate to the size of the vessel. You can manually move the POI to another point in the vessel, and the asymmetric Doppler gate cross will still automatically adjust to the size of the vessel.

Outline of VFI Workflow

The screen capture in Fig 7-19 outlines the main features of the VFI workflow:

- 1 Asymmetric Doppler gate
- 2 POI

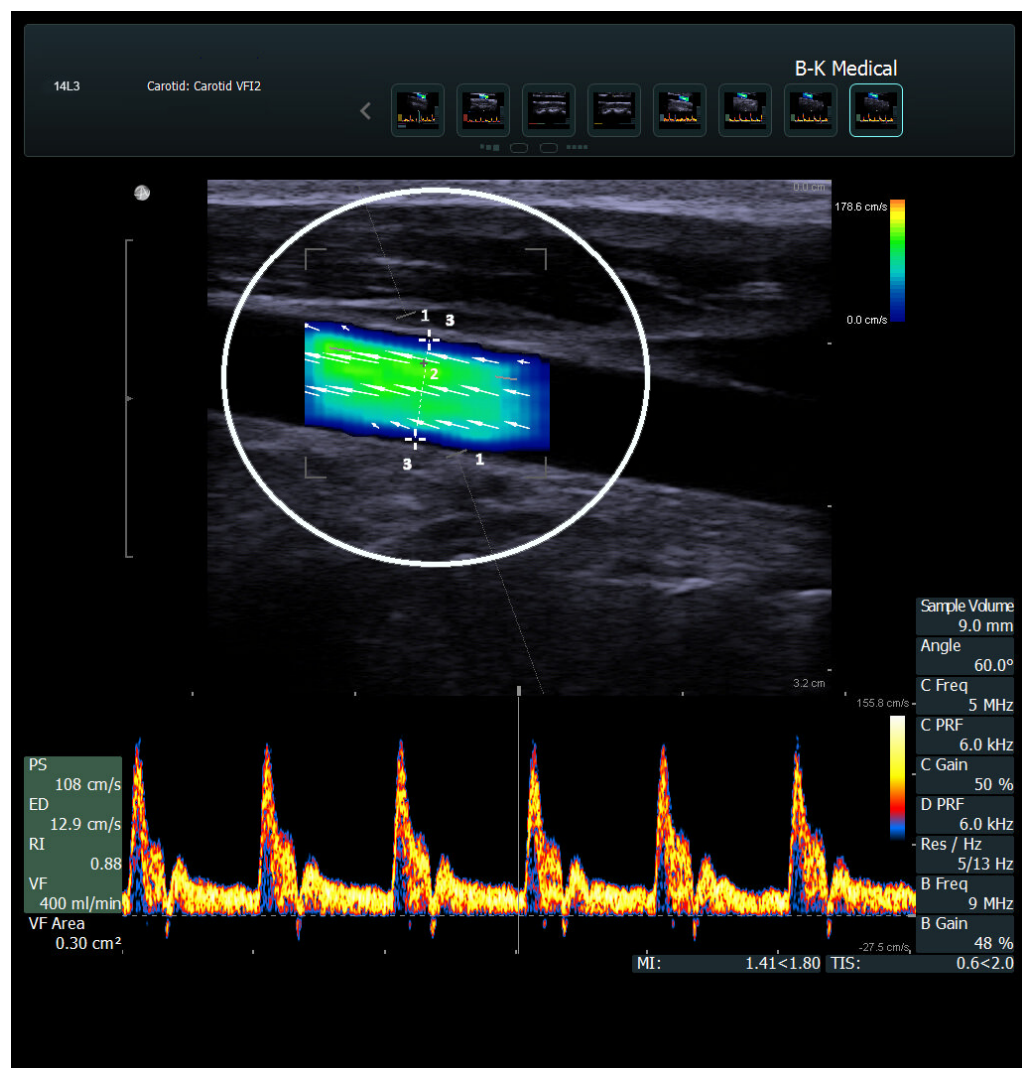

Figure 7-19. Outline of VFI workflow with 14L3 transducer.

Doppler Mode – Spectral Doppler

Doppler mode (spectral Doppler mode) imaging displays information about the spectrum of flow velocities as a function of time. It is sometimes called FFT (Fast Fourier Transform) because the information is presented as a frequency spectrum indicating velocity components.

Turning Doppler Mode On or Off

When you turn Doppler mode on, B-mode must be imaging.

To turn on Doppler mode:

- Press the **Doppler Mode** key.

The Doppler indicator, including both the Doppler line and the Doppler gate, appears superimposed on the B-mode image and the Doppler spectrum appears.

To position the Doppler gate on a larger B-mode image, press the **Doppler Gate** key and position the Doppler gate before you press the **Doppler Mode** key.

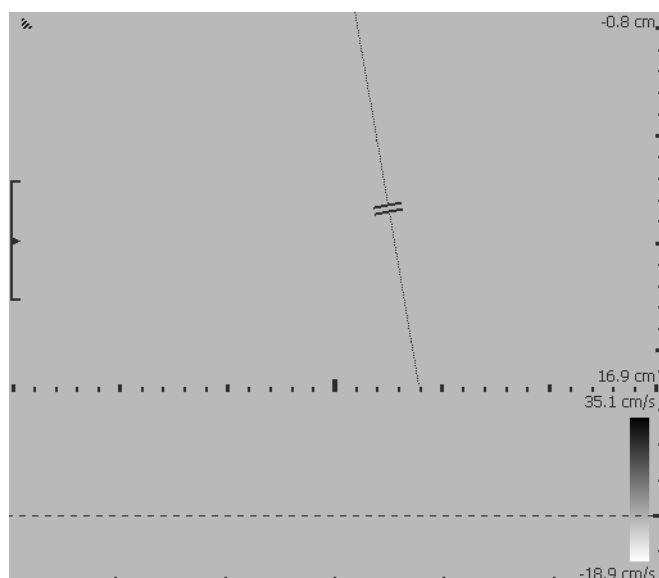

Figure 7-20. The Doppler indicator (line and gate) superimposed on a B-mode image.

Fig 7-21 shows information available in Doppler indicators.

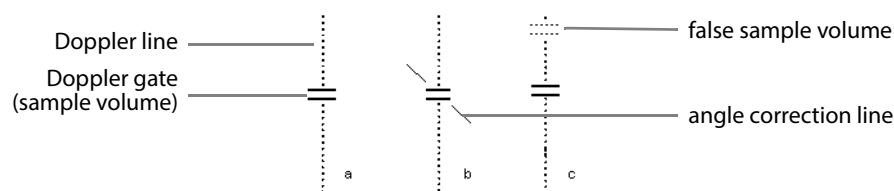

Figure 7-21. Doppler indicators (three examples).

Fig 7-21 (a) The dotted line represents the Doppler line. The lines at right angles to that show the Doppler gate.

Fig 7-21 (b) A diagonal line (relative to the Doppler line) indicates a sample volume with angle correction.

Fig 7-21 (c) The horizontal dotted lines show the false sample volume in HPRF (see page 101).

To turn off Doppler mode:

- Press the **Doppler Mode** key or the **B-Mode** key.

Adjusting the Doppler Mode Image

Doppler Indicator

When Doppler mode imaging is turned on, the Doppler indicator is superimposed on the B-mode image.

You can adjust the position and size of the Doppler gate to get information from sample volumes in various parts of the B-mode image. The image must not be frozen when you do this.

To move the Doppler gate:

- Click the Doppler indicator or press the **Doppler Gate** key and drag the gate. The sample volume line moves along with the gate.

To resize the Doppler gate:

- Point at the Doppler indicator, (or click it, or press the **Doppler Gate** key) and then press **+/-**.

Independent D-Mode/C-Mode Steering

Independent steering of PW Doppler and CFM is possible using the **Sync Steer** screen key. To enable independent steering, click **Sync Steer** under the advanced **Doppler** tab and switch the setting to **Off**.

NOTE: *This feature is only available for certain transducers and pro packages.*

Doppler Trace (Automatic Curve Tracing)

The system can automatically calculate and display a curve that traces the mean or peak values of the Doppler spectrum. See “Doppler Measurements” on page 113 for a description of the curves. You can also choose to have both the peak and mean curves displayed.

To change which curve is displayed or to turn off the display:

- Click **Trace** on the **Doppler** tab and select **Off**, **Peak**, **Mean+Peak**, or **Mean**.

To measure higher flow speeds (high range setting) in a sample volume placed deep in the tissue, HPRF (high PRF) is automatically used. When HPRF is active, the Doppler line shows the actual sample volume, and false sample volumes (shown dotted). See Fig 7-21 on page 100.

The false sample volumes should always be placed outside a vessel.

Sweep Speed

You can adjust the sweep speed to change the number of cycles of the spectrum displayed on the full time axis. The available values range from 2 (slowest) to 8 (fastest).

To select the sweep speed:

- Click **Sweep** on the advanced **Image** tab and select the required value. The time axis is updated.

M-Mode

There is no M-mode key on the keyboard.

To turn M-mode on or off:

- Click the **M-mode** subtab of the **Image** tab.

NOTE: *M-mode is only available for certain Pro Packages. The M-mode tab is visible only when M-mode is available.*

M-mode (motion mode) ultrasound is produced by slowly sweeping one line of a B-mode image across the monitor. The M-mode image illustrates a time series of images along this line.

M-mode can only be used in combination with B-mode. Selecting any other mode will turn off M-mode.

You can return to imaging with B-mode alone by pressing the **B-Mode** key.

M-mode uses the same imaging frequency and focus settings as B-mode.

NOTE: *Only a single focal zone is possible in M-mode.*

Zooming and panning do not work directly in the M-mode image. When you make changes in the B-mode image, they are applied to the M-mode image.

The M-Mode Image

When M-mode is selected, the monitor is divided into two windows (see Fig 7-22). You can adjust how the two windows are displayed.

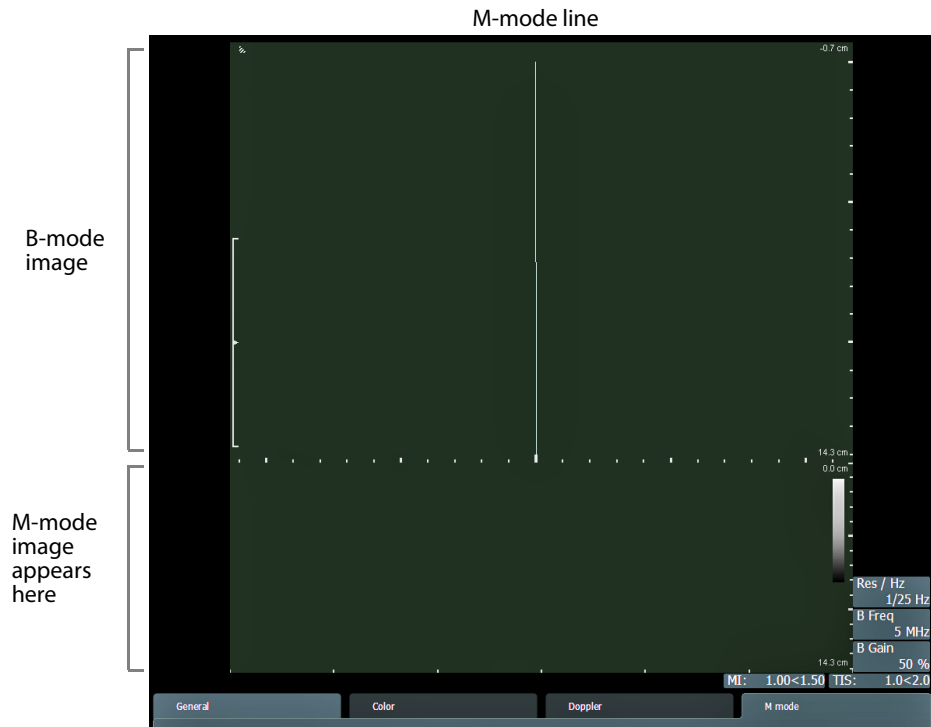

Figure 7-22. M-mode image.

M-Mode Line

The M-mode line (see Fig 7-22) shows the path of the M-mode image in the B-mode window. You can adjust the path of the image by moving the M-mode line (click it and drag).

M-Mode Image Ruler

The M-mode image ruler scales the ruler range of the B-mode image to the M-mode image. Any given value will represent the same position on both the M-mode and B-mode images.

It is not possible to change the ruler.

Saving a Preset

When you have changed the setup, you can save it as a new preset.

To save a preset:

- 1 On the **Image** tab, click **Advanced**. Then click **Save**.

The **Save Preset** window appears.

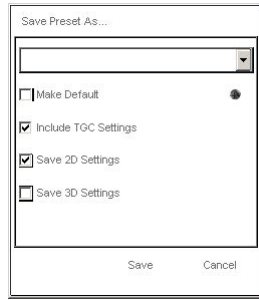

Figure 7-23. The Save Preset window.

- 2** Enter a name for the preset and select the options you want, for example, whether you want the setup to be the default for the transducer with the current Pro Package. (Puncture guide or brachy matrix settings will be saved as part of the setup.)
- 3** Click **Save**.

Chapter 8

Continuous Wave Doppler Mode

Overview

In Continuous Wave (CW) Doppler¹ mode, ultrasound is transmitted along a line as a continuous wave and analyzed as it returns. CW Doppler provides greater velocity ranges when measuring high flow regions such as flow through the cardiac valves, especially with stenosis.

Adjusting the Thermal Index Limit

Before you use CW Doppler mode, check that the TI settings are appropriate. The current TI tissue type and limit are displayed just under the BK Medical logo in the upper left corner of the monitor.

Adjusting MI

You can adjust the maximum allowed MI (mechanical index).

To adjust the MI limit:

- Click **MI** and drag the slider.

CW Doppler is a low voltage mode, so the MI will always be low.

Turning CW Doppler Mode On or Off

You must turn CW Doppler on and position the CW Doppler line before you turn on the CW spectrum.

To turn on CW Doppler mode:

Make sure that you are imaging in B-mode and the image is not frozen.

- Click **CW-Mode**.

The CW Doppler line appears superimposed on the B-mode image.

Drag the line to the position you want.

To unfreeze the CW Doppler spectrum:

- Press $\left[\frac{W}{S} \right]$

NOTE: *The B-mode image is frozen while the live CW Doppler spectrum is displayed.*

To switch between live B-mode and live CW Doppler mode:

- Press $\left[\frac{W}{S} \right]$.

1. CW Doppler on the bk3000 and bk5000 has not been licensed by Health Canada.

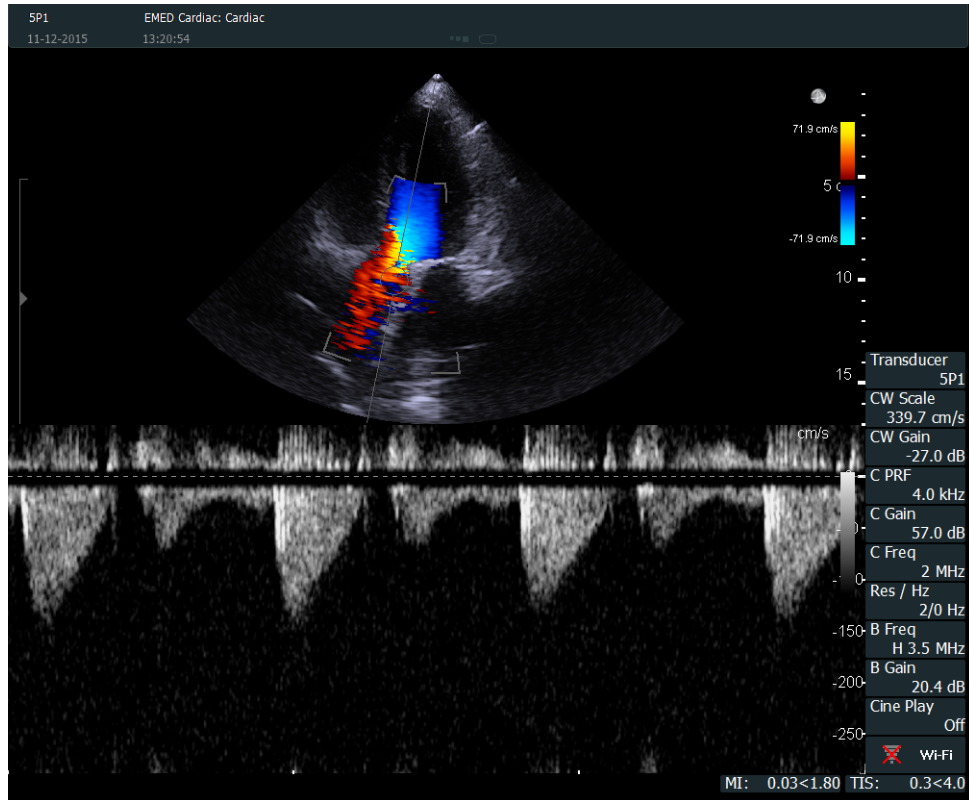

Figure 8-1. The CW Doppler line superimposed on a B-mode image.

To turn off CW Doppler mode:

- Click **CW-Mode**.

CW Doppler Line

CW Doppler information is acquired along the full length of the CW Doppler line. When CW Doppler is turned on, the CW Doppler line is superimposed on the B-mode image.

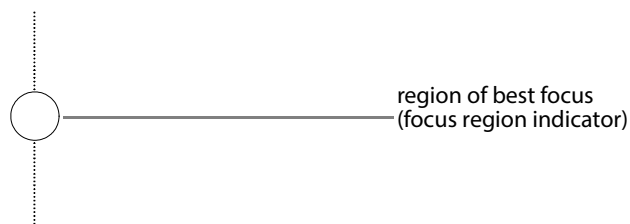

Figure 8-2. CW Doppler line.

The dotted line is the CW Doppler line. The circle indicates the region where the CW Doppler signal is best focused.

When CW Doppler mode imaging is turned on, the CW Doppler line is superimposed on the B-mode image.

You can adjust the position of the line to get information from samples in various parts of the B-mode image. Place the focus region indicator on the region of interest. The system must be imaging when you do this.

To move the CW Doppler line and focus region indicator:

- 1 Select the CW Doppler line by clicking on it or by pressing $\left[\frac{1}{f}\right]$.
- 2 Drag to the desired position. Moving the trackball to the left or right moves the line, and moving the trackball up and down moves the focus region along the line.

Audio Volume

The CW Doppler signal can be played as an audio signal as well as appearing on the monitor.

To adjust the volume of the audio signal:

- Press **[Sound ]**.

Adjusting the Doppler Mode Image

Doppler Trace (Automatic Curve Tracing)

You can have the system automatically calculate and display a curve that traces the mean or peak values of the Doppler spectrum. You can also choose to have both the peak and mean curves displayed.

To change which curve is displayed or to turn off the display:

- 1 Click **Trace** under **Image** on the right side of the monitor.
- 2 Click **Off**, **Peak**, **Mean+Peak** or **Mean** to the right of **Trace**.

NOTE: A CW Doppler signal is much weaker than a PW Doppler signal. Therefore, automatic curve tracing does not always give good results, and measurements based on the curve will not be accurate. If the automatic curve is not a good fit to the signal, you must manually draw the curve to be used for measurements.

Auto

The system can automatically adjust the Baseline and Scale to prevent aliasing and optimize the display of the Doppler spectrum.

To optimize the baseline and scale for the current Doppler spectrum:

- Press **[Auto ]**.

NOTE: The control panel (except for **Freeze** $\left[\text{⊗}\right]$) is disabled while the scale and baseline are being adjusted. This may take a few seconds.

Gain

You can adjust the gain of the CW Doppler mode image. The view must be imaging when you do this.

To adjust CW Doppler mode gain:

- Click **Gain** on the center of the monitor and drag the slider (or point at **Gain** and press +/-).

The current Doppler gain setting (a percentage) is displayed on the monitor next to **Gain**.

Scale

In CW Doppler mode, you can vary the scale of the displayed spectrum.

To adjust the velocity scale:

- Click **Scale** under **CW-Mode** on the left side of the monitor and drag the slider (or point at **Scale** and press +/-).

The vertical scale is updated to correspond to the new range of velocities.

The current setting is displayed on the monitor next to **Scale**.

NOTE: *The wall filter value will be changed automatically when you change the scale.*

Smooth

In CW Doppler mode, you can change how smooth the displayed spectrum looks.

To change the smoothness of the spectrum display:

- Click **Smooth** under **CW-Mode** on the left side of the monitor and select the degree of smoothness you want (or point at **Smooth** and press +/-).

Wall Filter

In CW Doppler mode, you can set the cutoff frequency for the wall filter.

To set the cutoff frequency for the wall filter:

- Click **Wall Filter** under **CW-Mode** on the left side of the monitor and select the value you want (or point at **Wall Filter** and press +/-).

or

- Press [**Filter** ] to step through the available values.

The current setting is displayed on the monitor next to **Wall Filter**.

Invert

In CW Doppler mode, you can invert the spectrum on the monitor.

To invert the spectrum or to return to the default:

- Press [**Inverse**] to toggle between the default and inverted spectrum coding.

The frequency axis is inverted to match the spectrum.

Baseline

In CW Doppler mode, you can reposition the baseline. The baseline separates forward flow from reversed flow, and moving the axis can help overcome aliasing problems.

To adjust the baseline:

- Press [**Baseline** \updownarrow] to move the baseline up or down.
or
- Point at the baseline and press +/-.
The frequency axis is updated to match the spectrum.

Sweep Speed

You can adjust the sweep speed to change the number of cycles of the spectrum displayed on the full time axis.

To select the sweep speed:

- Click **Sweep** on the right side of the monitor and select the submode you want (or point at **Sweep** and press +/-).
The current setting is displayed on the monitor next to **Sweep**.
The time axis is updated.

Chapter 9

Pro Packages

Before You Begin

The information in this user guide may not correspond to the Pro Packages on your system as Pro Packages can be customized.

Before reading about the Pro Packages, you should already be familiar with:

- Working with images on the system (Chapter 4, “Working with the Image”).
- Making measurements with the system (Chapter 5, “Making Measurements”).
- Documenting the image and its results (Chapter 6, “Documentation”).

The tables and formulas that the system uses for calculations are in the *Technical Data (BZ2100)*.

If You Perform a Puncture Procedure

Before you perform any puncture procedure, including therapy, make sure you have read the warnings in the Puncture and Brachytherapy section of the Safety chapter in the bk3000 & bk5000 User Guide.

	<p>WARNING P-w1</p> <p>Before you start imaging, verify that the type number or name of the transducer and the type number or description of the needle guide you are using match the number displayed on the monitor. Also make sure that the needle guide is positioned correctly. If the numbers do not match, or if the needle guide position is not correct, the puncture line on the monitor may not correspond to the true puncture path in the tissue. In case of any inconsistency, stop imaging, turn off the system, and contact your BK service representative.</p>
---	--

What Is a Pro Package?

A Pro Package is a pre-defined configuration for the layout and user interface of the monitor. There are different Pro Packages for different types of examinations.

Your choice of Pro Package determines:

- Patient information fields needed for the examination
- Specialized presets
- Layout of controls on the monitor (including which controls are available)
- Labels and bodymarks
- Reports
- Measuring tools and calculations

Presets

A preset is a pre-defined setup that optimizes the image for a particular type of imaging. It includes suitable settings for gain, frequency, etc.

The Examination Type you can select on the system is a combination of a Pro Package and a preset.

The following Pro Packages are available on the system:

- Abdomen
- Brachy
- Breast
- Cardiac
- Carotid
- Colorectal
- Gyn
- Gyn Follicles
- MSK
- Neuro (bk5000 only)
- OB
- Pediatric
- Pelvic Floor
- Small Part
- Surgery (bk5000 only)
- UGRA Anes
- Uro Abdominal
- Uro Prostate
- Uro Small Part
- Vascular

The information in the first part of this chapter applies to all Pro Packages. Any additional information that applies to certain packages is described in the following sections:

- “Using the Brachy Pro Package” starting on page 119.
- “Using the OB, Gyn, and Gyn Follicles Pro Packages” starting on page 124.

Measurements

Each Pro Package contains a set of measurements and calculations that are appropriate for a specific type of examination. Measurements vary according to the specific Pro Package, but the general instructions for making a measurement are the same.

To make a measurement:

- 1** On the **Measure and Mark** tab, click the measurement you want. (If you don't see the one you want, click **More Meas.** – visible when **Advanced** is on.)
The appropriate measuring marker or tool appears on the image.
- 2** Position the marker where you want it (or draw with the drawing tool).
If another marker is needed, it appears after you position the previous one.
- 3** Continue to position all needed markers.

After you have positioned all the markers, the result appears at the bottom left side of the monitor, see Fig 2-1 on page 15.

To redefine measurement screen keys, see Appendix D, “Redefining Screen Keys – Label, Bodymark, and Measurement”.

Doppler Measurements

Many Pro Packages contain Doppler measurements, as most vascular calculations involve making measurements on a Doppler (FFT) spectrum.

You can fit a curve to the spectrum either automatically (see “Doppler Trace (Automatic Curve Tracing)” on page 101) or manually and then make measurements on the curve.

Two curve types are generally used.

This type of curve	is a trace of...
Peak (Max)	maximum points of the spectrum (those farthest from the baseline).
Mean	mean points of the spectrum.

Table 9-1. Two types of Doppler curves.

	<p>WARNING M-w2</p> <p>Drawings of Doppler curves, manual and automatic, are meant as tools for positioning cursors so that measurements based on the curves can be calculated automatically. The General Pro Package contains no facilities for checking whether the automatic measurements are reasonable. Curves drawn on very noisy spectra may lead to misplacement of measurement cursors. Make sure that measurement cursors are positioned so that the results are reasonable. If they are not, you must adjust the position of the cursors manually.</p>
---	--

Fig 9-1 depicts a Doppler spectrum with two cycles. A cycle starts at the *start systole* (when the heart starts to contract) and ends at the *end diastole* (when the heart is resting and filled with blood). The correct placement of vascular calculation markers is indicated in the figure; their abbreviations are as follows:

- | | | | |
|-----------|---------------|-----------|------------------|
| SS | Start systole | MD | Minimum diastole |
| PS | Peak systole | ED | End diastole |
| ES | End systole | | |

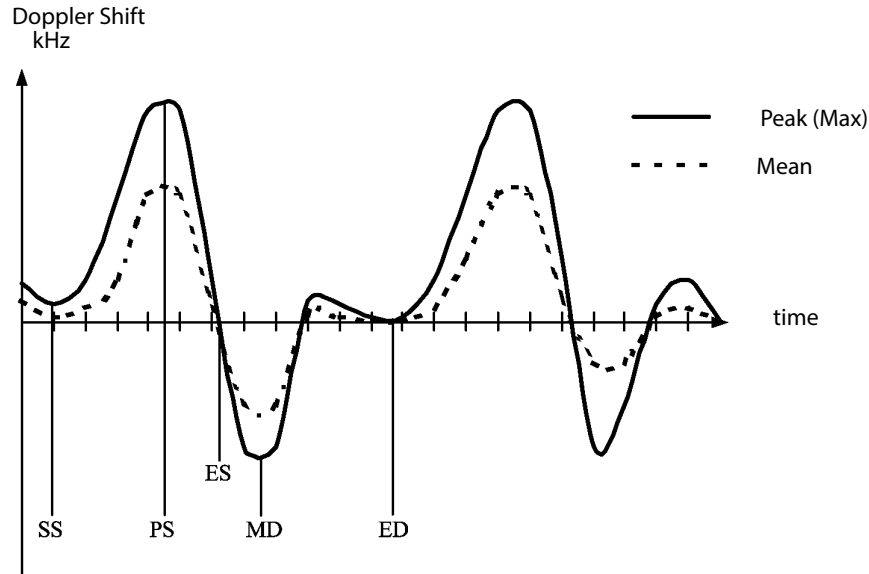

Figure 9-1. Doppler spectrum including vascular calculation markers.

The calculations and the way in which they are presented on the monitor depend on whether the Doppler angle is active or not.

Doppler Angle Active? (Yes/No)	Velocity or Frequency
No	Frequency measured at intersection of marker line and Doppler curve.
Yes	Velocity measured, and frequency parameters replaced by corresponding velocity parameters, (dF by dV, FACC by ACC, F1 and F2 by V1 and V2.)

When the Doppler angle is turned off or altered, the results are recalculated.

Stenosis

The stenosis measurement uses the area of the vessel before or after the stenosis and the area of the vessel at the stenosis (residual lumen) to calculate the degree (%) of stenosis. You can base the stenosis calculation on the distance across the vessel or the area of the vessel lumen.

To find the stenosis measurements, go to the **Measure and Mark** tab, and click **More Meas.** (**Advanced** must be on). After you select the measurement type, click on the image to place your measurement points.

Stenosis Based on Distance

The available measurements are:

- **ST Dist 1** – Measures the total lumen of the vessel.
- **ST Dist 2** – Measures the residual lumen of the vessel.

The **ST Dist** value is updated continuously on the monitor; if you move one of the markers, you reposition the markers.

Stenosis Based on Ellipses or Freehand Drawings

When you use areas to calculate stenosis, make one area measurement to measure each of the following:

- Total lumen of the vessel (use **ST Ellipse 1** or **ST Free 1**)
- Residual lumen of the vessel (use **ST Ellipse 2** or **ST Free 2**)

The result on the monitor is continuously updated while you position the second ellipse or drawing.

VF (Volume Flow)

VF (volume flow) is calculated by multiplying the time average mean velocity (TAM) by a defined cross-section of a vascular structure. The cross-section is measured on a B-mode image; the TAM is measured on a Doppler spectrum. These do not have to be measured on the same image.

You can calculate VF based on cross-section measures using a distance (VF Dist), an ellipse (VF Ell), or a circle (VF Circ).

NOTE: *VF can only be measured with the Doppler angle on.*

TAM (Time Average Mean) and TAMX (Time Average Max)

- TAM = average value (over time) of mean frequencies in the Doppler spectrum.
- TAMX = average value (over time) of the maximum frequencies in the Doppler spectrum.

You can measure TAM and TAMX in different ways:

- Automatic – you position markers on the spectrum (using the automatic curve tracing, if that is turned on), and the automatic Doppler curve is used with the markers to calculate TAM or TAMX.
- Manual – you draw several cycles of the Doppler curve manually.

TAM and TAMX can only be measured with the Doppler angle on.

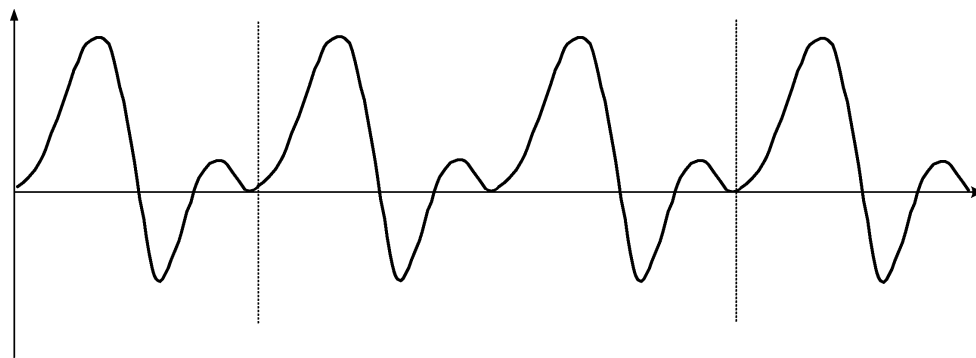

Figure 9-2. Measuring TAM on the Doppler spectrum.

To measure TAM or TAMX using the automatic Doppler curve:

- 1 Click **Auto** and make sure that **TAM** or **TAMX** is selected.
- 2 Position 2 line markers to specify the time interval (number of cycles) over which the frequency values are averaged. (See Fig 9-2.)

The TAM or TAMX value is displayed.

NOTE: Turn on the Doppler trace to make sure that the trace appears to be a good fit to the spectrum so that the basis for the automatic calculation is correct.

You can also draw a Doppler curve manually on the spectrum and use it to measure TAM or TAMX.

To measure TAM manually:

- 1 Click **TAM**.
- 2 Draw a curve that follows the mean frequencies of the spectrum, starting and ending at the same part of the cycle.

The TAM value is displayed to the left of the image.

NOTE: If you follow the procedure above, but draw the curve to outline the maximum frequencies, the value that is displayed as **TAM** is actually a TAMX value.

RI and PI (Resistance Index and Pulsatility Index)

The resistance index (Pourcelot index) is based on the peak systolic velocity (V_{max}) and the end-diastolic minimum velocity ED (V_{ed}) in a supply vessel. RI indicates the level of impedance to blood flow; a high RI suggests increased peripheral vascular resistance.

The pulsatility index represents the hemodynamic conditions in a vessel. It is based on the peak systolic velocity (V_{max}), the maximum velocity at minimum diastole ($V_{min-diast}$), and the average (V_{mean}) of the peak (max) flow velocity curve. PI describes the elasticity of the vessel combined with the level of peripheral resistance.

The A/B ratio (Stuart index) is calculated as the ratio between PS (V_{ps}) and ED (V_{ed}).

The advantage of using indices rather than absolute velocities is that the indices are independent of the insonation angle.

Index	Formula
A/B ratio	PS/ED
Resistance index	(PS-ED)/PS
Pulsatility index	(PS-MD)/Mean

Table 9-2. Formulas for the main Doppler indices.

The correct placement of markers for measuring RI and PI is indicated in Fig 9-1. “Mean” in the Pulsatility index formula is the averaged max flow velocity.

RI (Resistance Index)

To calculate RI and the A/B and B/A ratios, place one marker to measure Peak Systolic Frequency (PS) and one to measure End Diastolic Frequency (ED).

To measure RI:

- 1 Click **RI**.

- 2 Position the first marker to measure PS.
The PS measurement is displayed.
- 3 Position the second marker to measure ED.
The ED measurement is displayed.
The calculated RI value is displayed.

PI (Pulsatility Index)

You can measure PI in different ways:

- Automatic – the Doppler curve is drawn automatically and you position markers on it.
- Manual – you draw the Doppler curve manually (freehand).
- Real-time – the system calculates and displays PI automatically in real time. See “Real-Time Measurements” on page 117.

To measure PI automatically:

- 1 Click **Auto**, then make sure that **PI** is selected.
- 2 Position one marker at the *start systolic* (SS) frequency.
- 3 Position the second marker at the *end diastolic* (ED) frequency.
The PI measurement is displayed to the left of the image.

If more than one cycle is included between the time cursors, the calculated PI is an average over the cycles.

NOTE: *Make sure that the trace appears to be a good fit to the spectrum so that the basis for the automatic calculation is correct.*

To measure PI manually:

- 1 Click **PI**.
- 2 Position the marker on the *start systolic* (SS) frequency and click.
- 3 Draw a curve that traces a line along the whole maximum spectrum through the *peak systolic* (PS) frequency, the *minimum diastolic* (MD), and onto the *end diastolic* (ED) frequency.
- 4 Click.
The PI measurement is displayed.

If the traced curve covers more than one cycle, the PI is calculated as the average of each cycle.

Real-Time Measurements

The following measurements can be made and displayed in real time, so that they are continually updated during imaging:

- | | | | |
|------|------|------|--------|
| • PS | • MD | • RI | • TAM |
| • ED | • PI | • HR | • TAMX |

To turn real-time measurements on and off:

- On the **Measure and Mark** tab, click **Real-Time**.

When real-time measurements are turned on, automatic curve tracing can also be turned on. See “Doppler Trace (Automatic Curve Tracing)” on page 101. Make sure that the trace appears to be a good fit to the spectrum *so that the basis for the real-time calculation is correct.*

On the **Miscellaneous** tab of the **Measurement Setup** window, you can set the system to display the Doppler real-time calculations. See page 262.

NOTE: *You can collapse the section on the left that contains measurement results. If real-time measurements are not displayed, check to see whether the **Measurement** section is collapsed.*

NOTE: *If you freeze the image when real-time measurements are selected, the real-time results are also frozen.*

Noise Limit

You can reduce the noise (high frequency disturbances) in the data to improve the accuracy of automatically traced curves.

To reduce the noise:

- Click **Noise Limit** and drag the slider.

Low noise limits cut out less noise; high limits cut out more.

Noise Limit only appears on the monitor when automatic curve tracing is turned on.

Carotid Velocities

LICA, RICA, LCCA, RCCA, LECA, RECA, V1 and V2 are carotid velocities that are used to calculate the extent of stenosis in the carotid vessels.

The displayed velocity ratios are constantly updated as you change the measurement of either of the velocities in the ratio.

Doppler measurements that can be used to accurately assess flow-limiting stenosis are:

- Peak systolic velocity – determined at the point of maximum stenosis. The peak velocity is measured at the peak systolic point of the cardiac cycle.
- End diastolic velocity – determined at the point of maximum stenosis. The end diastolic velocity is measured at the end point of the cardiac cycle.

Carotid Measurements

Structured Reporting

You can measure velocities and ratios at three sites: proximal, mid and distal.



Figure 9-3. Carotid measurements.

Click on **Report** to access ability to **Edit Carotid Results**.

This is the worksheet where you change how the measurements are reported. See also “Using Reports” on page 136.

Calculations

The calculation formulas and accuracies, along with the tables and formulas used by the system, are in the *Technical Data (BZ2100)*.

Using the Brachy Pro Package

The Brachy Pro Package is designed for ultrasound-guided brachytherapy and cryotherapy for prostate cancer. This Pro Package helps you measure the volume of the prostate.

NOTE: *If you have the VariSeed or Live Image Transfer licenses activated, the image size is locked by default for the Brachy Pro Package. See Fig C-2 on page 247.*

NOTE: *Before you perform any puncture procedure, including brachytherapy, make sure you have read the warnings in the Puncture and Brachytherapy section of the Safety chapter in the bk3000 & bk5000 User Guide.*

For information about calculating PSAD see the Urology Pro Package chapter.

Patient Setup

The **Patient** window for this Pro Package contains the following special fields for PSA and Gleason Score parameters:

Parameter	Range allowed
PSA	0 – 1000
Gleason	2 – 10

Table 9-3. Brachy parameters in the Patient setup window.

Calculating Volumes

Organ volumes can be calculated in several ways. For the formulas used for each of these calculations, and information about their accuracy, see the *Technical Data (BZ2100)*.

NOTE: A volume calculation based on a measured ellipse is critically dependent on the axis of rotation that you choose. See page 44.

Planimetry (Contouring)

For this method, you record several parallel B-mode images that cover the organ to be measured. On each image, you draw a curve that traces the outline of the structure, thereby creating a set of parallel section measurements of the structure.

These parallel sections (the outline measurements) are used to estimate the volume of the structure based on several equally spaced slices.

The accuracy of this method depends on starting the measurements in the correct place. Start at one end of the organ, where the image shows an area of as close to 0 as possible. After each step, trace the outline of the structure on the image. The system calculates the volume of the structure between the starting point and each new image (see Fig 9-4). This is continued until the whole organ has been covered and a total volume obtained.

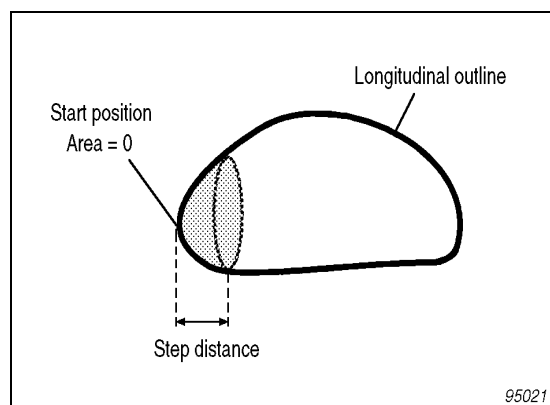

Figure 9-4. Longitudinal outline of organ showing the start position for planimetry.

Different stepping units to control the spacing between the sections are available for use with different transducers.

To use this method to calculate the volume of a particular organ, use the Planimetry (Ellipse) or Planimetry (Freehand) measurements in the submenu for that organ volume. The planimetry method is only available for the prostate and adenoma.

To make a planimetry calculation:

- 1 Record a B-mode image at the far end of the organ.
- 2 Move the transducer back one step.
- 3 Freeze the image.
- 4 On the **Measure and Mark** tab, click **Pr-Planimetry**.
- 5 Draw to outline the prostate.
- 6 Draw an outline around any other structures of interest, such as the rectal wall or ureter.
- 7 Unfreeze the image.
- 8 Repeat steps 2 through 6 until you have covered the entire organ.

The prostate volume is displayed (updated after each measurement is drawn) at the bottom of the data area to the left of the image.

To reset the volume, long press the **Measure** key.

Automatic Planimetry

Automatic planimetry uses orthogonal transverse and longitudinal B-mode area measurements to form the basis for a simulated planimetry volume calculation.

You can make automatic planimetry measurements using Ellipse or Freehand drawing.

NOTE: *For automatic planimetry calculations, the transverse outlined area must represent the shape of the organ.*

This method estimates volume by automatically performing simulated planimetry. The estimation is based on the convex outlines of two orthogonal sections – transverse and longitudinal. It is assumed that the shape of the transverse area outline represents the shape of any transverse area in the organ (see Fig 9-4). The longitudinal outline must be the largest area that can be seen, and these measurements must be made at right angles to each other and to the transducer axis, and from the same transducer position.

To perform automatic planimetry:

- 1 On the **Measure and Mark** tab, click **More Meas.** and select **Ellipse (Prostate Volume Ellipse)** from the list to make an ellipse measurement on a transverse image. (**Advanced** must be on).
- 2 Record a longitudinal image at a right angle to, and from the same transducer position as, the transverse image.
- 3 Repeat step 1 to measure the organ on the transverse image.

You can use **Ellipse** for measuring in one plane and **Freehand** in the other plane. The system calculates the volume, and results are displayed on the monitor and entered into the Urology report.

- Requirements
- The longitudinal outline must be:
 - The largest area that can be seen.

The two sections must be:

- At right angles to each other.
- At right angles to the transducer axis.
- Taken from the same transducer position.

Performing a Biopsy or Puncture Procedure (including Brachytherapy)

NOTE: It is important to verify that you are using the correct puncture guide. The number of the guide is displayed at the top of the image. Make sure the number corresponds to the guide you are using. If it doesn't, click the number on the monitor to select the proper needle guide.

When you use a transducer (such as the E14CL4b for brachytherapy, a brachytherapy needle guide matrix (brachy matrix) is superimposed on the image.

To superimpose a brachy matrix on an ultrasound image:

- Press the **Puncture Guide** key.
The default brachy matrix appears.

To set a different brachy matrix to be the default:

- After you have selected the brachy matrix you want (and made any other setup changes you want), save your settings as a new preset. Specify that you want the new setup to be your default.

To highlight the dot on a brachy matrix where you expect to see the needle:

- Click one of the dots on the brachy matrix.
A blue square appears in its place.
- To highlight a different dot, click it. The previously highlighted dot returns to normal and the new one is highlighted.

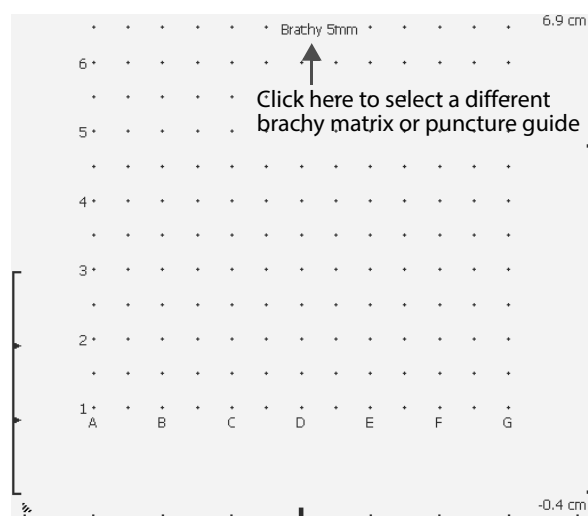

Figure 9-5. A brachy matrix on the image area.

To select a different puncture guide or brachy matrix:

- 1 Click the Type number or brachy matrix name displayed at the top of the image area.
- 2 Click the puncture guide or brachy matrix you want.

To remove the brachy matrix from the monitor:

- Press the **Puncture Guide** key.

Programmable Puncture Guide

If you are using a programmable puncture guide, you can change the setup to move it to the left or right or in or out.

Brachy Ruler with Sagittal Plane Imaging

You can set up the system so that a brachy ruler is displayed when you image in the sagittal plane with the E14CL4b transducer, in situations where a brachy matrix appears in the transverse imaging view.

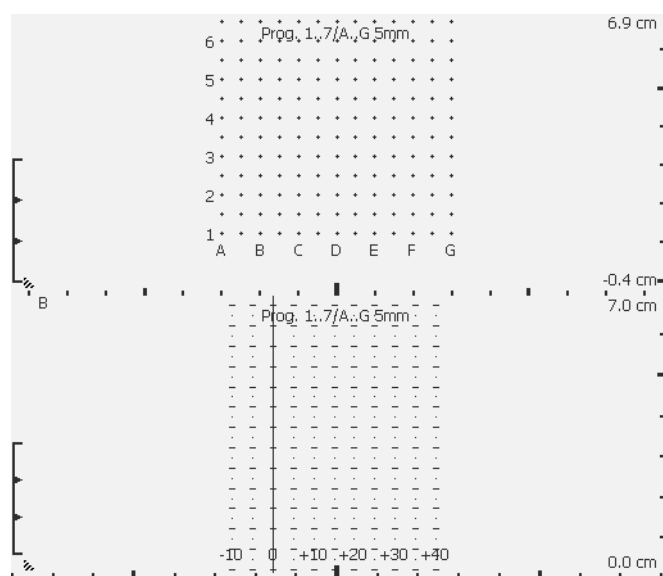

Figure 9-6. A split-screen view with transverse brachy matrix above and sagittal brachy ruler below. Ruler has vertical line to mark 0.

The sagittal brachy ruler is sometimes displayed with a 2-dimensional grid, to make it easier for you to see the horizontal position of the needle no matter where it is in the vertical direction.

To move the ruler to the left or right:

- 1 Click the zero position on the horizontal (bottom) axis.
- 2 Drag the vertical line that replaces the ruler markers.
- 3 Click when the line is positioned where you want the new zero position of the ruler.

The vertical line disappears and the ruler markers appear in their new positions.

NOTE: You can set up the system so that a vertical 0 line is always visible, along with the markers as shown in Fig 9-6.

User-Definable Brachy Matrix and Ruler

You can also define your own brachy matrix and ruler. See page 275.

Using the OB, Gyn, and Gyn Follicles Pro Packages

The OB, Gyn and Gyn Follicles¹ Pro Packages are designed for use in obstetrical and gynecological ultrasound applications.

Gestational Age and Expected Date of Confinement

You can calculate the gestational age (GA) and expected date of confinement (EDC) from measurements on the ultrasound image, or from clinical parameters such as date of last menstrual period. You can also use the results of an earlier examination instead of the last menstrual period date to estimate the GA and EDC.

Enter the information you want to use in the **Patient** window.

Patient Setup

The **Patient** window for this Pro Package contains the following special fields:

Field	Enter this information
Last Mens. Date	Date of last menstrual period (abbreviated LMP in reports).
Prev. Exam. Date	Date of exam with reference data.
Ref. Data Method	Method to use for making clinical estimates of GA or EDC (CRL, BPD, FL, AC, or HC).
Reference Data	Data to use for making clinical estimates of GA or EDC.
Menopause	Month/year of menopause.
Length of Cycle	Number of days of menstrual cycle.

Table 9-4. Special fields in Patient window for OB, Gyn and Gyn Follicles Pro Packages.

Making Measurements

For detailed instructions for using the measuring tools, see “Measurements and Calculations” starting on page 39.

If the result of a measurement is outside the allowed range of values, this is indicated on the monitor:

>>>> too high

<<<< too low

If this happens, you may have made a mistake in your measurement or you may be trying to use a measurement that is inappropriate (for example, for the GA).

NOTE: *It is not possible to base a CI measurement on an HC measurement that is made with any measuring tool other than an ellipse.*

1. This system is not market cleared by the FDA for IVF use in the USA.

Nuchal Translucency

Nuchal translucency measurements require special training. See Caution NT-c1 in the Measurements section of the Safety chapter in the *bk3000 & bk5000 User Guide*.

Calculation Methods

General Information

This Pro Package contains measuring tools that can be used to calculate gestational age (GA), fetal weight (FW), and expected date of confinement (EDC). The calculations are based on measurements of the ultrasound image such as biparietal diameter (BPD) or abdominal circumference (AC).

Unless otherwise noted, in this chapter GA is expressed in days, FW in grams (g), and distances are in millimeters (mm).

NOTE: *Ovary and uterus volume measurements use the HWL factor specified on the Miscellaneous tab of the Measurements setup window. See page 273.*

Follicle Diameter Measurements

You can measure the (average) diameter of a follicle using one, two, or three diameters (**FD1**, **FD2**, or **FD3**).

Obstetrics Reports

Obstetrics reports can contain the results of clinical calculations of GA and EDC, as well as calculations based on measurements of the ultrasound image.

For more information about editing, printing, and saving reports, see “Reports” on page 67.

Curves in Reports

If you enter information in the **Patient** window about a previous measurement (CRL, BPD, FL, AC, or HC) or the date of the last menstrual period, the report includes reference curves for the current measurements.

The **Curve Setup** window (see Fig C-19 on page 270) contains a list of all available curves (including any user-defined ones). Some curves also have associated percentile curves – these will be displayed along with the main curve.

Each curve is on a separate page of the report. Click **Next Page** and **Previous Page** on the report to see the various curves. If you delete a measurement from a report, the curve associated with that measurement is also deleted.

Example of an OB Report with Curves

Here is an example of a report. A previous BPD measurement was entered in the **Patient** window to be used as a basis for the curves.

NOTE: *The reports on the system will not look exactly like the one illustrated here.*

Obstetrics Report							16:29:46	1/1
Jane Doe, NoID								
	Measurements			Mean	GA	EDC		
BPD - Campbell	80.4 mm	75.0 mm	78.9 mm	78.1 mm	30w 0d	13-01-2010		
AC - Campbell	250 mm	258 mm	248 mm	252 mm	29w 2d	18-01-2010		
FL - Campbell	57.1 mm	57.2 mm	57.4 mm	57.2 mm	30w 1d	12-01-2010		
	Clinical	Ultrasound						
GA:		29w 6d						
EDC:		14-01-2010						
	Other Measurements			Mean				
APD	109 mm	72.0 mm		72.7 mm	84.6 mm			
ATD	49.6 mm	92.1 mm		85.0 mm	75.6 mm			
Remarks:								

Figure 9-7. First page of an OB report.

In Fig 9-8, note that the gestational age assumed for the second (current) examination is based only on the gestational age estimated at the first examination plus the elapsed time. The current measurements do not affect it.

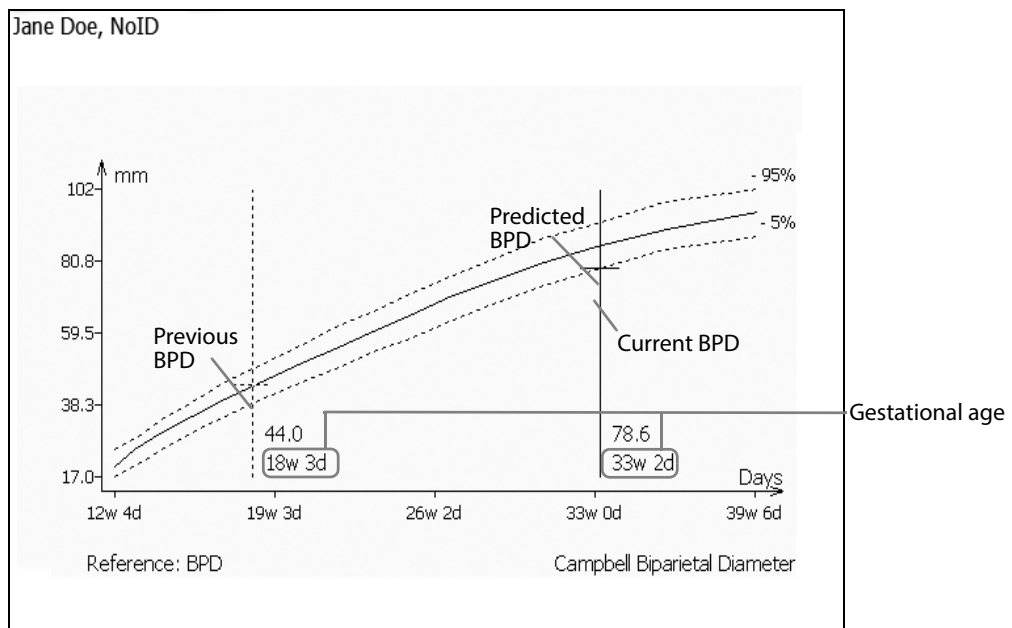

Figure 9-8. Campbell BPD curve in OB report.

Fig 9-9 shows the position of the AC measured today compared to AC reference curves based on the BPD measured previously.

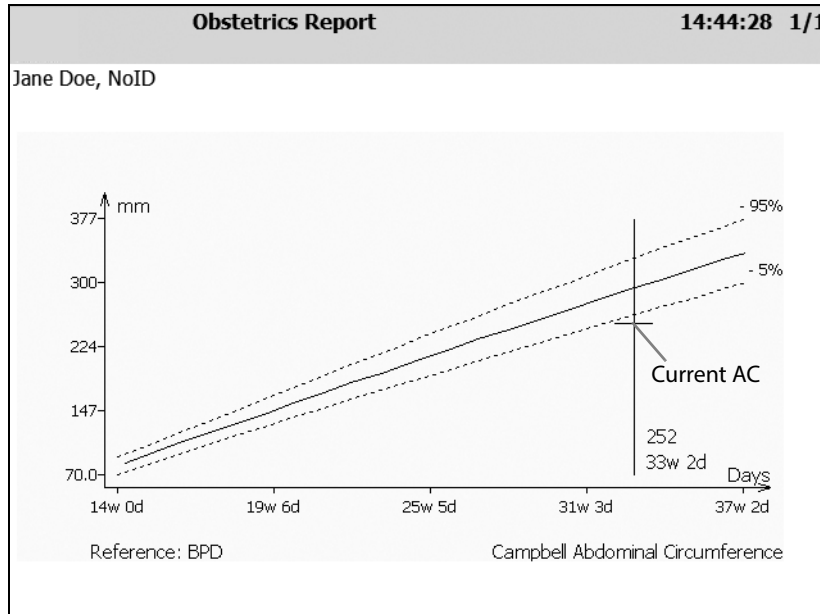

Figure 9-9. Campbell AC curve in OB report.

Fig 9-10 shows the position of the FL measured today compared to FL reference curves based on the BPD measured previously.

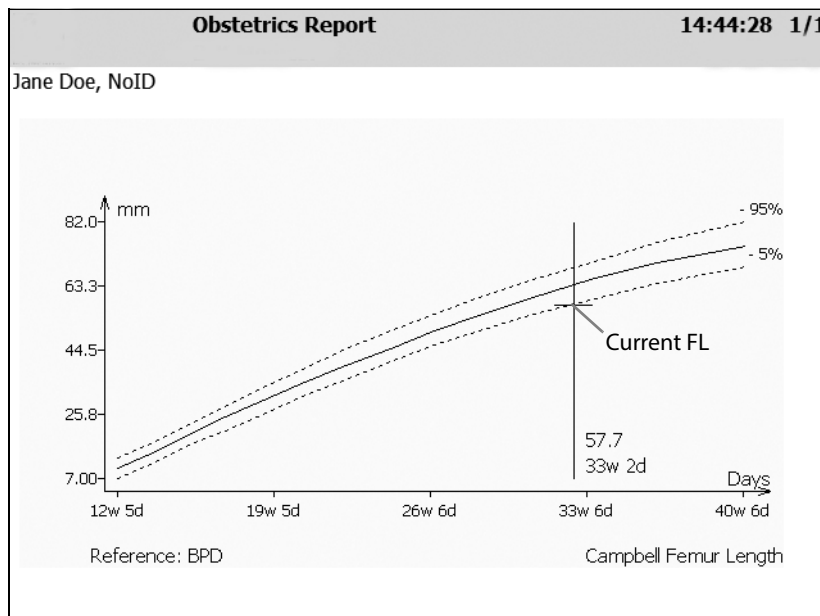

Figure 9-10. Campbell FL curve in OB report.

The report page shown in Fig 9-11 shows how much the fetal weight measured today deviates from the fetal weight expected for today's gestational age. Today's gestational age is predicted from the previously measured BPD and the elapsed time.

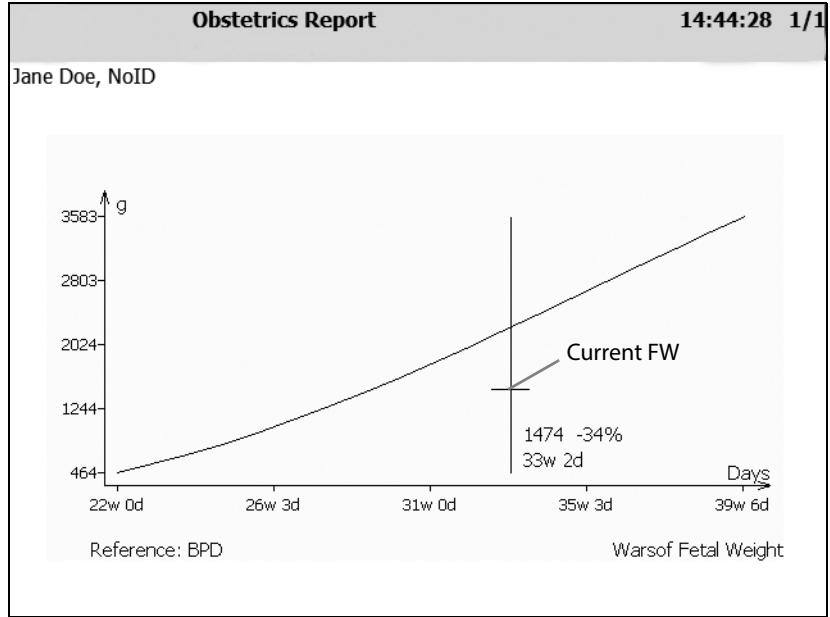

Figure 9-11. Warsof fetal weight curve in OB report.

Chapter 10

Vascular Pro Package

This Pro Package contains information useful for basic Vascular Imaging including:

- Peripheral arteries
- Peripheral veins

Carotid measurement information can be found under “Carotid Velocities” on page 118

Important:

Read *Getting Started with bk3000 & bk5000* for basic controls.

Read transducer user guides for more information before doing biopsies.

Read *Care and Cleaning* for sterilization instructions.

Read *bk3000 & bk5000 User Guide* before using the system.

Contents

- Presets
- Setting up the Patient – Patient ID
- Imaging Controls
- Annotations – Labels and Bodymarks
- Measurements and Calculations
- Using Reports
- Capturing and Documenting Images
- Customization Examples
- Vascular Measurement Abbreviations
- Where to Find More Information

Presets

Once you have selected your transducer, click the **Vascular Pro Package** and select the appropriate preset. These will vary with each transducer.

Setting up the Patient – Patient ID

You must have a patient ID in order to save images

- 1 Press **Patient** on the keyboard or click **Enter Patient** on the monitor.
- 2 Enter data in the **Patient** window.
- 3 Click **Start Exam** (below the **Patient** window).



The screenshot shows a 'Patient' window with the following fields:

Patient ID	Last Name
20140729113141	
First Name	Middle Name
Accession Number	Birth Date
Sex	Operator
Perf. Physician	Ref. Physician
Patient Comment	

Figure 10-1. Patient window.

If two or more transducers are connected, the system will always change to default preset/pro package when you change transducers.

Imaging Controls

B-Mode (2D)

Imaging starts in B-mode.

To return to imaging with B-mode alone after you have been using it in combination with other modes, press the **B-Mode** key on the keyboard.

Gain:

- Adjust gain by *turning* the **B-Mode** key on the keyboard (when the image is not frozen) or clicking **Gain** on the monitor and selecting a value. You can also use the **+/-** key on the keyboard to change the value of the **Gain** screen key (slider).

Different gain at different image depths: adjusting the TGC curve:

- Move the **TGC** sliders on the keyboard to the right or left to adjust the TGC curve (differential gain).

The shape of the TGC curve is temporarily displayed to the right of the image as a curved vertical line.

Split Screen

To use split screen:

- 1 To split the screen so you can see two images, press the **Split Screen** key on the keyboard.
- 2 Image and freeze.
- 3 Press **Split Screen** again, image in the second screen.
- 4 Freeze.
- 5 To go back to full screen, press the **Split Screen** key for more than 1 second.

Color Mode (CFM)

To use Color mode:

- 1 Press **Color Mode** key on keyboard, or click **Color** tab on monitor. Color box is active (blue color) and can be moved with trackball.
- 2 To resize color box and keep default shape use **+ /-** key.
- 3 To change the shape (for example, narrow the width), click a corner of the box and drag the corner. Click when you are finished.

Color gain:

- Adjust color gain by *turning* **Color Mode** key or clicking **Gain** on monitor and selecting a value. You can also use the **+ /-** key on the keyboard to change the value of the **Gain** screen key.

Scale:

- Change PRF with scale keyboard button or screen scale controls.

Vector Flow Imaging

To use VFI - Vector Flow Imaging¹:

- 1 On the **Color** tab, click the **Submode** screen key.
- 2 Click **VFI** to select it as the submode.

NOTE: You must have a license from BK Medical to use VFI. VFI is only available for some transducers.

Color Maps:

- To change the colors that are assigned to different flow velocities, click the color bar on image area and click the color bar that you want.

Doppler Mode

To use Doppler mode:

- 1 Press the **Doppler Mode** key on keyboard, or click **Doppler** tab on monitor. Doppler sample gate is active (blue). Move with trackball.
- 2 Adjust size of Doppler gate with **+/-** key
- 3 Adjust gain by turning **Doppler Mode** key or using the **Gain** screen control.
- 4 To adjust volume, PRF, baseline, sweep speed, use keys on keyboard or click **Advanced** on the **Doppler** tab to use screen controls.

Auto

Click **Auto** to have the system adjust baseline and PRF automatically. The adjustment requires a few vascular cycles before the adjustment is complete.

1. Vector Flow Imaging on the bk3000 and bk5000 has not been licensed by Health Canada.

Volume Flow

To use Volume Flow:

- 1 In PW Doppler, click on **VF (auto)**¹ measurement. Calipers appear to measure the diameter of the vessel, then vertical measurement lines appear on the Doppler spectral trace.
- 2 Place the first one at the beginning of a cardiac cycle and then place the second one farther along the spectral trace to include at least two cardiac cycles. Volume flow rate appears in ml/min.

NOTE: *If your system has a license for VFI, then start Color Mode and when you click on **Doppler**, the system will automatically do the following,*

- steer the color box
 - find the highest volume in the area imaged
 - angle correctly to give you a Doppler spectral trace.
- 3 Press the **Doppler Gate** key to update the VFI information.

To get automatic volume flow calculations:

- 4 Click on **VF (real time)** and your system will automatically measure vessel diameter and TAM and give you a volume flow result in ml/min.

Annotations – Labels and Bodymarks

Labels and bodymarks are activated from the **Measure and Mark** tab that appears when you freeze the image.

NOTE: *When an annotation screen key is colored (different from the default color), it means that clicking it will cause a drop-down menu to be displayed.*

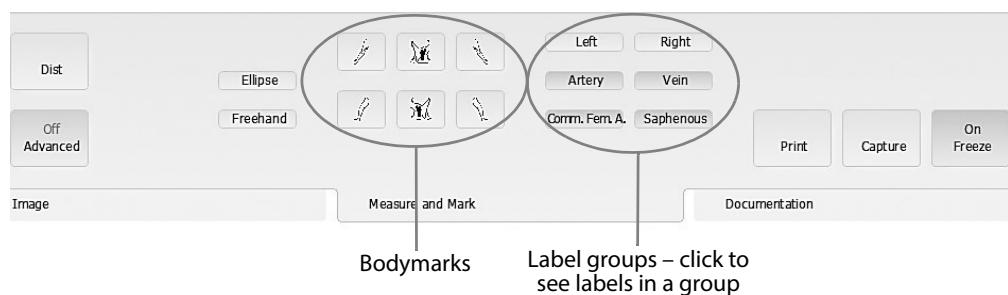

Figure 10-2. Measure and Mark tab in the Vascular Pro Package.

1. VF (auto) means Volume Flow based on Auto TAM, where TAM is Time Average Mean.

Labels

To select a label:

- 1 Make sure the image is frozen. On the **Measure and Mark** tab, click the label you want or click a label group (blue screen control) and then click the label (in the list that appears).

The label appears on the image.

- 2 Use the trackball to move the label and then click when it is in the correct position.

Type and edit your own labels on screen:

- 1 Type the text you want for the label.
You can move the label while you are typing it.
- 2 Click to accept the label text and position.

To move or edit a label:

- 1 To move a label that is on the image, click the label to select it, and use the trackball to move it.
- 2 To edit a label on the image, click the label (label turns blue).
- 3 Use backspace to move through the label and edit it. You can also use the arrow keys on the keyboard to move the cursor while editing.

To remove a label:

- Long click the label you want to remove (point at it and press the **Select** key for more than 1 second) or unfreeze.

As a default, the system erases all annotations on unfreeze.

Aligning labels:

- **Horizontally:** Press the space bar on the keyboard after you type the label.
- **Vertically:** Press the **Return** key after you type the label.

Bodymarks

The following vascular bodymarks are available:

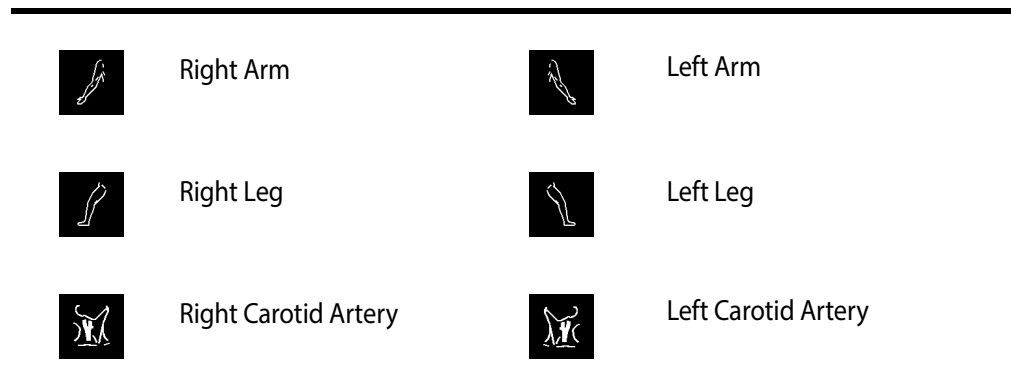

Figure 10-3. Vascular bodymarks.

To place a bodymark on the image:

- 1 Freeze the image.
- 2 On the **Measure and Mark** tab, click the bodymark you want. (If you don't see the one you want, click **More Bodymarks** – visible when **Advanced** is On.)
The bodymark appears on the monitor with an imaging plane indicator.
- 3 Drag and click the imaging plane indicator to position it; use the +/- key to rotate it.
- 4 Click to set the position.

To move a bodymark:

- 1 Click on or near it, so that the frame around it turns blue.
- 2 Drag it to the position you want, and click again.

Setting default position:

- 1 Position bodymark on image.
- 2 Click **Advanced** and then click on circle on top right of bodymark.
- 3 Click **Settings...**
- 4 Click **Set as Default Position**.



Measurements and Calculations

Measurement abbreviations are listed and defined at the end of this chapter.

Using the Calculation Package

2D Measurements



Figure 10-4. Measure and Mark tab. 2D Measurements.

Choose the vessel you are interested in:

- 1 Freeze the image and click the top tab for your area of interest, for example **Right Leg Veins**.
- 2 Click **Vessel/Diameter** and choose a blood vessel from the drop-down menu.

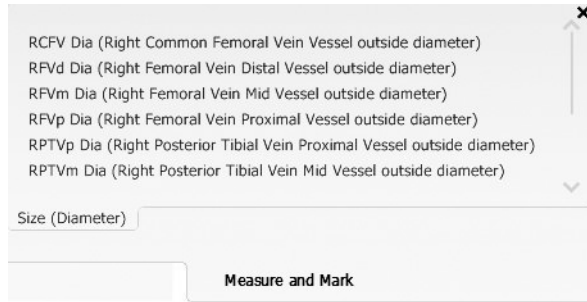

Figure 10-5. Vessel/Diameter drop-down menu.

Measure the vessel diameter:

- 1 Place first cursor and click.
- 2 Place second cursor and click.

The measurement is displayed on the monitor and the name of the vessel is copied to a result list. As a default, for leg vein vessels, the result list appears on the upper right side of the monitor.

Check boxes can be used to record the state of the blood vessel:

COMP.	Compression
SPONT.	Spontaneous
PHASIC	Phasic
AUGM.	Augmentation
REFLUX	Reflux



Figure 10-6. Result List

This information can be recorded in a report.

Doppler Measurements

Leg Veins (Peripheral Vein preset)

- 1 In Doppler mode, freeze the image with the Doppler spectrum.



Figure 10-7. Measure and Mark tab. Peripheral Vein preset.

- 2 Click the top tab for your area of interest, for example **Right Leg Veins**.
- 3 To measure vessel closure time (VCT), click the screen key for the blood vessel and measurement (for example, **RFV VCT**.)
- 4 Place first cursor at beginning of reflux and click.
- 5 Place second cursor at end of reflux and click.
Vessel closure time is displayed.

Leg Arteries (Peripheral arteries preset)

- 1 In Doppler mode, freeze the image with the Doppler spectrum.



Figure 10-8. Measure and Mark tab. Peripheral Arteries preset.

- 2 Click the top tab for your area of interest, for example **Right Leg Arteries**.
- 3 To measure peak systolic velocity (PS), click the screen key for the blood vessel and measurement (for example, RFA PS).
- 4 Place cursor at peak systole and click.
Peak systolic velocity (PS) is displayed.

Using Reports

Setting up a report:

- 1 On the **Documentation** tab, click **Report**.

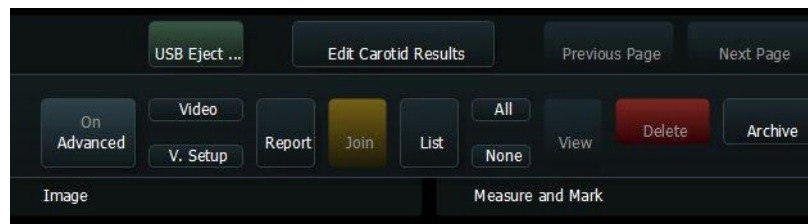

Figure 10-9. The editing tab for reports.

- 2 Click the editing tab for the results you want in your report .
- 3 Set up the way you want the measurements to be displayed in the report.

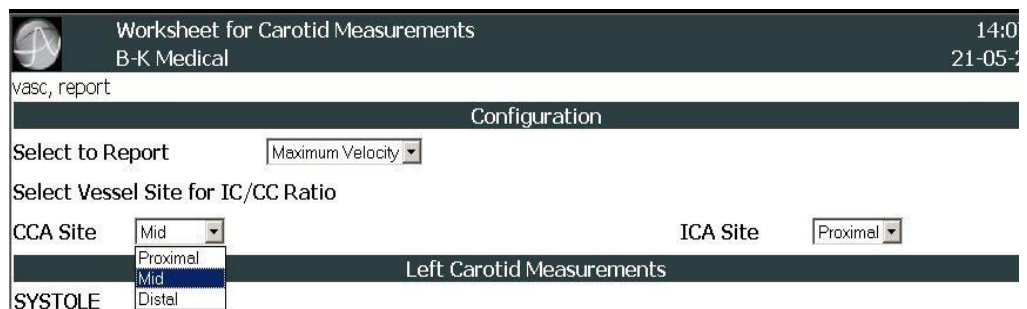

Figure 10-10. Edit report sheet for Carotid Measurements.

Making and printing a report:

- 1 When you have finished making measurements, click on any thumbnail images you want in the report. They will appear on the second page of the report.
- 2 Click **Report** on the **Documentation** tab.

Carotid Measurements			
Left Side		Right Side	
		RCCAm PS	59.5 cm/s
		RICAp PS	57.3 cm/s
		RCCAm ED	13.6 cm/s
		RICAp ED	20.2 cm/s
LICA/LCCA (PS)	NA	RICA/RCCA (PS)	0.96
LICA/LCCA (ED)	NA	RICA/RCCA (ED)	1.49

Figure 10-11. Part of a carotid report.

Comments put in the **Patient** window appear in the report.

You can type up to 4 lines of remarks on the first page of the report.

- 3 Edit the report if you need to. You can edit in the report itself or on the editing tab for the report. To change a measurement, click the number (measurement). In the figure below, that means click on 57.3.

Right Carotid Measurements				
SYSTOLE	Peak Systole 1	Peak Systole 2	Peak Systole 3	For Report
RCCAm PS	59.5			59.5 cm/s
RICAp PS	57.3			57.3 cm/s
RICA/RCCA				0.96

Update
Delete
Cancel

Editing window that appears if you click 57.3.

Figure 10-12. Editing a measurement on a report.

A small window opens. In this window, you can:

- Type a new value (in the blue area) and click **Update** (measurement is updated).
- Click **Delete** (measurement is deleted).
- Click **Cancel** (measurement is unchanged).

- 4 Click **Print** to print the report before saving it.
- 5 Click **Save** (on the right, below the report) to save the report.

NOTE: Reports can be saved as documents or captured as images but cannot be printed directly from the thumbnails. In either case, open the thumbnail to print from the monitor.

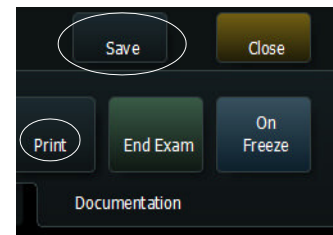

Figure 10-13. To **Save** or **Print** a report.

Capturing and Documenting Images

Cine Review

To use cine review:

- 1 Freeze image.
- 2 Turn **B-Mode** key to scroll back through imaging.

or

Click **Cine Play** on the right side of the monitor and press the +/- key to turn it on and off.

Capturing Images

Capturing Frozen Images

Saving (capturing) images to system hard disk:

- 1 Freeze the image.
- 2 Click **Capture**.

Thumbnail of saved image appears in the document browser at the top of the monitor.

Capturing Clips (Unfrozen Images)

To capture clips:

- 1 Click **Capture** to start recording.
Capture control is red during recording.
- 2 Click **Capture** again to stop recording.

Thumbnail of image appears at top of monitor. (Play arrow is displayed on the thumbnail.)

Copying and Archiving

Copying or Archiving Images and Clips

To copy or archive images and clips:

- 1 Select thumbnail images.
- 2 On **Documentation** tab, select where to send the images.

Printing

Print images
displayed on
monitor

Printing Images Displayed on the Monitor

To print an image displayed on the monitor:

- Press the **Print** key on the keyboard.

You can customize how the **Print** key works.

To specify which printer the key will print to:

- 1 Make sure the image is not frozen.
- 2 Click **Advanced**, then **Customize**.
- 3 Click the **Keys/Menus** tab and in the **Assignments** pane in the window, find **Print**.
- 4 Click **Print** and select a printer in the drop-down menu that appears.

A change in key assignment only affects the particular Pro Package that is selected in the left pane on the tab.

Printing from Thumbnail Images

To print thumbnail images (including archived ones) without opening them:

- 1 Click the thumbnails you want to print (to select them).
- 2 On the **Documentation** tab, click **Print**.
- 3 Click the printer you want on the drop-down menu that appears.
The images are printed.

To open a thumbnail image and then print it:

- 1 Double-click the thumbnail image to open it.
- 2 On the **Measure and Mark** tab, click **Print**.
The default setting is for a black and white USB printer.

To set a different printer as default for the Print screen key:

- 1 Press **Fn+C** on the keyboard.
- 2 Click the little circle that appears on the top left corner of the **Print** screen key.
- 3 Scroll through the list that appears and click the printer you want.
- 4 Click the **x** in the top right corner of the list menu to close the menu and save your changes.

See Appendix E, “Configuring the bk3000 and bk5000” for more details.

Customization Examples

New Presets

Saving a new preset:

- 1 Make sure image is not frozen and is in B-mode.

- 2 Click **Advanced**.
- 3 Click **Save...**
The changed parameters are saved.
- 4 Name the new preset.
You can set it to be a default preset.
- 5 Click **Save**.
The new preset now appears under the Pro Package that you were using when you started to save the preset.

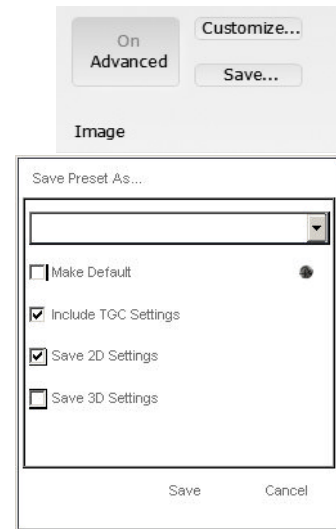

Figure 10-14. Saving a new preset

Default Pro Packages and Presets

If two or more transducers are connected, the system will always change to default preset/pro package when you change transducers.

You can change the default Pro Package and preset for a transducer.

Setting the default Pro Package and preset:

- 1 Activate the chosen transducer.
- 2 Make sure the image is not frozen, go to the **Image** tab and click **Advanced**.
- 3 Click **Customize**.
- 4 Click the **Pro/Setup** tab if it is not open.
- 5 In the table, scroll down the list of Pro Packages to find **Vascular**.
- 6 In this Pro Package, in the column for the chosen transducer, click the preset you want to be the default.
- 7 Click **Set Pro Package as Default** and **Set Preset as Default** (if you are changing both).
- 8 Click **Close**.

NOTE: User-defined presets will not have an icon associated with them.

Making a New Screen Key

To make a new screen key:

- 1 Press **Fn+C** and click on available space (one with little circles).

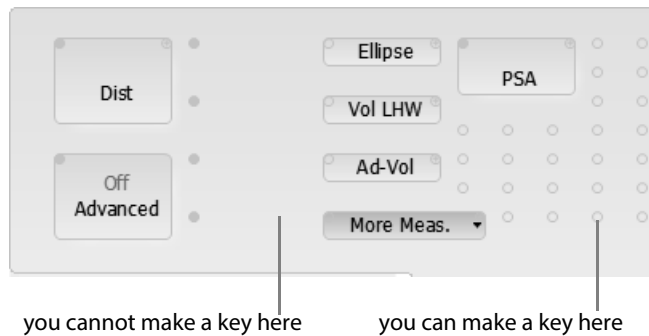

- 2 Select the key name (for example, **Labels clear all**) from the drop-down menu that appears.
- 3 Press **Fn+C** to save your new configuration and leave Configuration Mode.

Customizing Labels and Bodymarks Using Advanced Mode

Important: Save changes by going out of advanced screen (click **Advanced** so it is Off) and clicking **Save**.

Autocomplete labels:

Choose which labels you want to autocomplete as you type to save time.

- 1 Freeze the image.
- 2 Make sure that **Advanced** is On, then click **More Labels** to display a list of labels.
- 3 Select the ones you want to autocomplete by clicking the circle to the left of the label.

Now when you click **More Labels**, you will only get the shortened list that will autocomplete.

Quickly redefine a label/bodymark screen key:

- 1 Click on circle top right of screen key.
- 2 See the drop-down menu of possible choices.
- 3 Select the label or bodymark you want by clicking on the circle next to it in the list.

Keeping labels on screen when unfreezing image:

- 1 Make sure the image is not frozen.
- 2 Click **Advanced**, then **Customize**.
- 3 Click the **Labels/Marks** tab, and then, in the window that appears, the **Miscellaneous** tab.
- 4 Uncheck **Clear Labels on Unfreeze**.

Vascular Measurement Abbreviations

Leg Vein Measurements

Abbreviation	Long Name
RCFV VCT	Right Common Femoral Vein Valve Closure Time
RSFJ VCT	Right Saphenofemoral Junction Valve Closure Time
RFVp VCT	Right Femoral Vein Proximal Valve Closure Time
RFVm VCT	Right Femoral Vein Mid Valve Closure Time
RFVd VCT	Right Femoral Vein Distal Valve Closure Time
RPrnlVp VCT	Right Peroneal Vein Proximal Valve Closure Time
RPrnlVm VCT	Right Peroneal Vein Mid Valve Closure Time
RPrnlVd VCT	Right Peroneal Vein Distal Valve Closure Time
RPTVp VCT	Right Posterior Tibial Vein Proximal Valve Closure Time
RPTVm VCT	Right Posterior Tibial Vein Mid Valve Closure Time
RPTVd VCT	Right Posterior Tibial Vein Distal Valve Closure Time
RPopV VCT	Right Popliteal Vein Valve Closure Time
IVC VCT	Inferior Vena Cava Valve Closure Time
RGN VCT	Right Gastrocnemius Vein Valve Closure Time
RSL VCT	Right Soleal Vein Valve Closure Time
REIV VCT	Right External Iliac Vein Valve Closure Time
RCIV VCT	Right Common Iliac Vein Valve Closure Time
RLS VCT	Right Lesser Saphenous Vein Valve Closure Time
RPerf-H VCT	Right Hunterian Perforating Vein Valve Closure Time
RPerf-C VCT	Right Cockett's Perforating Vein Valve Closure Time
RPerf-B VCT	Right Boyd's Perforating Vein Valve Closure Time
RGSV VCT	Right Great Saphenous Vein Valve Closure Time
RGSV-C VCT	Right Great Saphenous Vein of Calf Valve Closure Time
RGSV-T VCT	Right Great Saphenous Vein of Thigh Valve Closure Time
RATV VCT	Right Anterior Tibial Vein Valve Closure Time
RPFVp VCT	Right Profunda Femoris Vein Valve Closure Time
LCFV VCT	Left Common Femoral Vein Valve Closure Time
LSFJ VCT	Left Saphenofemoral Junction Valve Closure Time
LFVp VCT	Left Femoral Vein Proximal Valve Closure Time
LFVm VCT	Left Femoral Vein Mid Valve Closure Time

LFVd VCT	Left Femoral Vein Distal Valve Closure Time
LPrnIVp VCT	Left Peroneal Vein Proximal Valve Closure Time
LPrnIVm VCT	Left Peroneal Vein Mid Valve Closure Time
LPrnIVd VCT	Left Peroneal Vein Distal Valve Closure Time
LPTVp VCT	Left Posterior Tibial Vein Proximal Valve Closure Time
LPTVm VCT	Left Posterior Tibial Vein Mid Valve Closure Time
LPTVd VCT	Left Posterior Tibial Vein Distal Valve Closure Time
LPopV VCT	Left Popliteal Vein Valve Closure Time
IVC VCT	Inferior Vena Cava Valve Closure Time
LGN VCT	Left Gastrocnemius Vein Valve Closure Time
LSL VCT	Left Soleal Vein Valve Closure Time
LEIV VCT	Left External Iliac Vein Valve Closure Time
LCIV VCT	Left Common Iliac Vein Valve Closure Time
LLS VCT	Left Lesser Saphenous Vein Valve Closure Time
LPerf-H VCT	Left Hunterian Perforating Vein Valve Closure Time
LPerf-C VCT	Left Cockett's Perforating Vein Valve Closure Time
LPerf-B VCT	Left Boyd's Perforating Vein Valve Closure Time
LGSV VCT	Left Great Saphenous Vein Valve Closure Time
LGSV-T VCT	Left Great Saphenous Vein of Thigh Valve Closure Time
LGSV-C VCT	Left Great Saphenous Vein of Calf Valve Closure Time
LATV VCT	Left Anterior Tibial Vein Valve Closure Time
LPFVp VCT	Left Profunda Femoris Vein Valve Closure Time

Artery Measurements

Abbreviation	Long Name
Aod PS	Aorta Distal Peak Systole
Aom PS	Aorta Mid Peak Systole
Aop PS	Aorta Proximal Peak Systole
RFAAd PS	Right Femoral Artery Distal Peak Systole
RFAm PS	Right Femoral Artery Mid Peak Systole
RFAp PS	Right Femoral Artery Proximal Peak Systole
RBGAp PS	Right Bypass Graft Proximal Anastomosis Peak Systole
RBGAd PS	Right Bypass Graft Distal Anastomosis Peak Systole
RCIA PS	Right Common Iliac Artery Peak Systole
REIA PS	Right External Iliac Artery Peak Systole

RCFA PS	Right Common Femoral Artery Peak Systole
RDPA PS	Right Dorsalis Pedis Artery Peak Systole
RBGI PS	Right Bypass Graft Inflow Peak Systole
RBGO PS	Right Bypass Graft Outflow Peak Systole
RPFAP PS	Right Profunda Femoris Artery Peak Systole
RPopA PS	Right Popliteal Artery Peak Systole
RPTAd PS	Right Posterior Tibial Artery Distal Peak Systole
RPTAm PS	Right Posterior Tibial Artery Mid Peak Systole
RPTAp PS	Right Posterior Tibial Artery Proximal Peak Systole
Aod PS	Aorta Distal Peak Systole
Aom PS	Aorta Mid Peak Systole
Aop PS	Aorta Proximal Peak Systole
LFAAd PS	Left Femoral Artery Distal Peak Systole
LFAm PS	Left Femoral Artery Mid Peak Systole
LFAp PS	Left Femoral Artery Proximal Peak Systole
LBGAp PS	Left Bypass Graft Proximal Anastomosis Peak Systole
LBGAd PS	Left Bypass Graft Distal Anastomosis Peak Systole
LCIA PS	Left Common Iliac Artery Peak Systole
LEIA PS	Left External Iliac Artery Peak Systole
LCFA PS	Left Common Femoral Artery Peak Systole
LDPA PS	Left Dorsalis Pedis Artery Peak Systole
LBGI PS	Left Bypass Graft Inflow Peak Systole
LBGO PS	Left Bypass Graft Outflow Peak Systole
LPFAP PS	Left Profunda Femoris Artery Peak Systole
LPopA PS	Left Popliteal Artery Peak Systole
LPTAd PS	Left Posterior Tibial Artery Distal Peak Systole
LPTAm PS	Left Posterior Tibial Artery Mid Peak Systole
LPTAp PS	Left Posterior Tibial Artery Proximal Peak Systole

Where to Find More Information

For more information about different topics, you may want to refer to the following chapters:

- Layout of controls on the monitor and how to use the workflow tabs (Chapter 2, “The User Interface”).
- Names of screen controls and what they do (Chapter 3, “Controls on the Monitor”).
- Working with images (Chapter 4, “Working with the Image”).
- Making measurements (Chapter 5, “Making Measurements”).
- Documenting the image and results (Chapter 6, “Documentation”).
- Using different imaging modes (Chapter 7, “Imaging Modes”).
- List of all measurement abbreviations with full name (Appendix B, “Measurement Abbreviations”).
- Setting up and Customizing the System (including creating custom keys on the keyboard) (Appendix C, “Setting Up and Customizing Your System”).
- Redefining screen keys and configuring the appearance of on-screen information, keys, input fields, etc. (Appendix D, “Redefining Screen Keys – Label, Bodymark, and Measurement” and Appendix E, “Configuring the bk3000 and bk5000”).

The tables and formulas that the system uses for calculations are in the *Technical Data (BZ2100)* on the *User Documentation CD*.

Chapter 11

Cardiac Pro Package

This Pro Package contains information useful for basic Cardiac Imaging including:

- Basic Cardiac imaging
- Emergency medicine cardiac imaging (FATE)

Important:

- Please see *Getting Started with bk3000 & bk5000* for basic controls.
- Read transducer user guides for more information before doing biopsies.
- Read *Care and Cleaning* for sterilization instructions.
- Read *bk3000 & bk5000 User Guide* before system use.

Contents

- Presets
- Setting up the Patient – Patient ID
- Imaging Controls
- Annotations – Labels and Bodymarks
- Measurements and Calculations
- Using Reports
- Capturing and Documenting images
- Customization Examples
- FATE – Focus Assessed Transthoracic Echocardiography
- Where to Find More Information

Presets

Once you have selected your transducer, click the **Cardiac Pro Package** and select **Cardiac** preset.

If two or more transducers are connected, the system will always change to default preset/pro package when you change transducers.

Setting up the Patient – Patient ID

You must have a patient ID in order to save images.

- 1 Press **Patient** on keyboard or click **Enter Patient** on the monitor.
- 2 Enter data in the **Patient** window.
- 3 Click **Start Exam** (below the **Patient** window).

Patient ID	Last Name
20140729113141	
First Name	Middle Name
Accession Number	Birth Date
Sex	Operator
Perf. Physidan	Ref. Physician
Patient Comment	

Figure 11-1. Patient window

Imaging Controls

B Mode (2D)

Imaging starts in B-mode.

To return to imaging with B-mode alone after you have been using it in combination with other modes, long press the **B-Mode** key on the keyboard.

Transducer Orientation

5P1 Transducer¹

- Sag – Transducer mark to right shoulder
- Trans – Mark to left shoulder

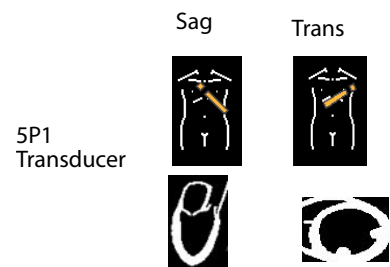

M-Mode

The M-mode tabs have an On/Off function. Click the tab to turn M-mode on and again to turn it off.

To use M-mode:

- 1 Click **M-Mode** tab on monitor. (You can create a custom M-Mode key on the keyboard (see “Creating a Custom Keyboard Key for M-Mode” starting on page 159).
M-Mode cursor is active (blue color) and can be moved with the trackball.
- 2 Adjust gain using **Doppler** key on the keyboard or **M-Gain** screen key.
- 3 Click **Sweep** screen key to adjust sweep speed.
- 4 Freeze the image in order to make measurements.
- 5 Unfreeze to restart M-Mode. Click the M-Mode cursor to reposition it with the trackball.
- 6 To exit M-mode, click the **M-Mode** tab.

1. The 5P1 transducer has not been licensed by Health Canada.

Color Mode (CFM)

To use Color mode:

- 1 Press **Color Mode** key on keyboard, or click **Color** tab on monitor. Color box is active (blue color) and can be moved with trackball.
- 2 To resize the color box and keep the default shape, use the **+ /-** key.
- 3 To decrease the color box width, click to deactivate the size cursor, then click on a corner of the box and drag the corner. (The cursor changes to a double arrow to show that you can change the shape.)
- 4 Click when you are finished changing the color box.

Color gain:

- Adjust color gain by *turning* the **Color Mode** key or clicking **Gain** on monitor and selecting a value. You can also use the **+ /-** key on the keyboard to change the value of the **Gain** screen key.

Scale:

- Change PRF with the **Scale** keyboard key or **Scale** screen key.

Doppler Mode

To use Doppler mode:

- 1 Press **Doppler Mode** key on keyboard, or click **Doppler** tab on monitor. Doppler sample gate is active (blue). Move with trackball.
- 2 Adjust size of Doppler gate with the **+/-** key
- 3 Adjust gain by turning **Doppler Mode** key or using the **Gain** screen control.
- 4 Press the **Doppler Angle** key to activate the Doppler angle control, then adjust the angle with the **+/-** key or trackball.
- 5 To adjust volume, PRF, baseline, sweep speed, use keys on keyboard or click **Advanced** on the **Doppler** tab to use screen controls.

Auto Control of Baseline and Scale

Click **Auto** to have the system adjust baseline and scale (PRF) automatically. The adjustment requires a few vascular cycles before the adjustment is complete.

Spectral Doppler Mode

Pulsed Wave Doppler (PW)

Default is update mode, which means that when you first press the **Doppler Mode** key you get a live 2D image but no spectral Doppler.

To get a live spectral Doppler tracing:

- 1 Press the **Update** key (above the **Doppler Mode** key).

You toggle between 2D and Doppler using the **Update** key. The **Undo** key is set for update mode as well, so you can use this instead of the hard update key.

*You may go to triplex mode (live 2D and Doppler spectral trace) with a long press on the **Update** key.*

- 2 Save this as a preset if desired.

Continuous Doppler (CW) (Cardiac Pro package only)

You will only see the soft button for **CW** after you have started Doppler mode and update mode.

To start Continuous Doppler:

- 1 Click the **CW** soft button.

To see live CW spectral trace:

- 2 Press the **Update** key.
There is only update mode in CW available, no triplex mode.
- 3 Press the **Doppler** key to go back to **PW**.

Annotations

Labels and bodymarks are activated from the **Measure and Mark** tab that appears when you freeze the image.

Labels

To select a label:

- 1 Make sure the image is frozen. On the **Measure and Mark** tab, click the label you want or click a label group (blue screen control) and then click the label (in the list that appears).
The label appears on the image.
- 2 Use the trackball to move the label and then click when it is in the correct position.

Type and edit your own labels on screen:

- 1 Type the text you want for the label.
You can move the label while you are typing it.
- 2 Click to accept the label text and position.

To move or edit a label:

- 1 To move a label that is on the image, click the label to select it, and use the trackball to move it.
- 2 To edit a label on the image, click the label (label turns blue).
- 3 Use backspace to move through the label and edit it. (You can also use the arrow keys on the keyboard to move the cursor while editing.)

To remove a label:

- Long click the label you want to remove (point at it and press the **Select** key for more than 1 second) or unfreeze.
As a default, the system erases all annotations on unfreeze.

Aligning labels:

- **Horizontally**: Press the space bar on the keyboard after you type the label.
- **Vertically**: Press the **Return** key after you type the label.

Bodymarks

To place a bodymark on the image:

- 1 Freeze the image.
- 2 On the **Measure and Mark** tab, click the bodymark you want. (If you don't see the one you want, click **More Bodymarks** – visible when **Advanced** is On.)
The bodymark appears on the monitor with an imaging plane indicator.
- 3 Drag and click the imaging plane indicator to position it; and use the **+/-** key to rotate it.
- 4 Click to set the position.

To move a bodymark:

- 1 Click on or near it, so that the frame around it turns blue.
- 2 Drag it to the position you want, and click again.

Setting default position:

- 1 Position bodymark on image.
- 2 Click **Advanced** and then click on circle on top right of bodymark.
- 3 Click **Settings...**
- 4 Click **Set as Default Position**.



Measurements and Calculations

Basic Cardiac Measurements

- LVV (Left Ventricular Volume)
EF (Ejection Fraction)
- PFV (Peak Flow Velocity)
PG (Pressure Gradient)
- VTI (Velocity Time Integral)
PG (Pressure Gradient)
MPG (Mean Pressure Gradient)
- HR (Heart Rate)

LVV (Left Ventricular Volume)

M-Mode

To measure LVV in M-mode:

- 1 Freeze the M-mode image, and on the **Measurement** tab, under **LV**, click **LV All**.

A measurement cursor appears to prompt you.

- 2 Measure the following:

- IVS d (Interventricular Septum in diastole)
- LVD d (Left Ventricular Diameter in diastole)
- LVPW d (Left Ventricular Posterior Wall in diastole)

The cursor changes to prompt you.

- 3 Measure the following:

- IVS s (Interventricular Septum in systole)
- LVD s (Left Ventricular Diameter in systole)
- LVPW s (Left Ventricular Posterior Wall in systole)

Calculations appear automatically on the screen for:

- EdV (End Diastolic Volume)
- EsV (End Systolic Volume)
- LVM (Left Ventricular Mass)
- FS (Fractional Shortening)
- EF (Ejection Fraction)
- SV (Stroke Volume)

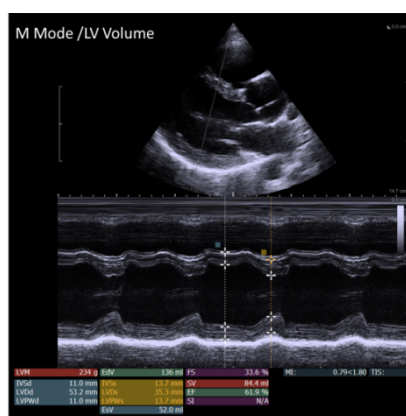

Figure 11-2. M-Mode/LV Volume measurements.

- 4 If you want to calculate BSA (Body Surface Area), click **BSA** and enter patient height and weight (in metric units) in the text box that appears. (Height and weight can also be entered in the **Patient Window**.)
- 5 Click **OK** and the calculation will be displayed on the screen.

- 6 Click **Cancel** (on the screen) to end the measurement or press **Enter** on the keyboard to make more calculations.

B-Mode

To measure LV Volume in B-mode:

- 1 Freeze the image and use the **B-Mode** key to scroll to End Diastolic phase.
- 2 To measure EdV (End Diastolic Volume):
 - Click **LV** tab
 - Click **EdV** screen key
 - Measure LVLd (Left Ventricular Length during diastole)

The cursor will change to freehand.

- 3 Position the cursor on LV and trace the internal dimensions.
- 4 When you are finished, click (press **Select** key).

EdV is calculated.

- 5 Use the **B-Mode** key to scroll to End Systole.

- 6 Click EsV (End Systolic Volume).

- 7 Measure LVLs (Left Ventricular Length during systole).

The cursor will change to freehand.

- 8 Position the cursor on LV and trace the internal dimensions.

- 9 When you are finished, click (press **Select** key).

Calculations will be shown automatically on the screen for:

- EdV (End Diastolic Volume)
- EsV (End Systolic Volume)
- EF (Ejection Fraction)
- SV (Stroke Volume)

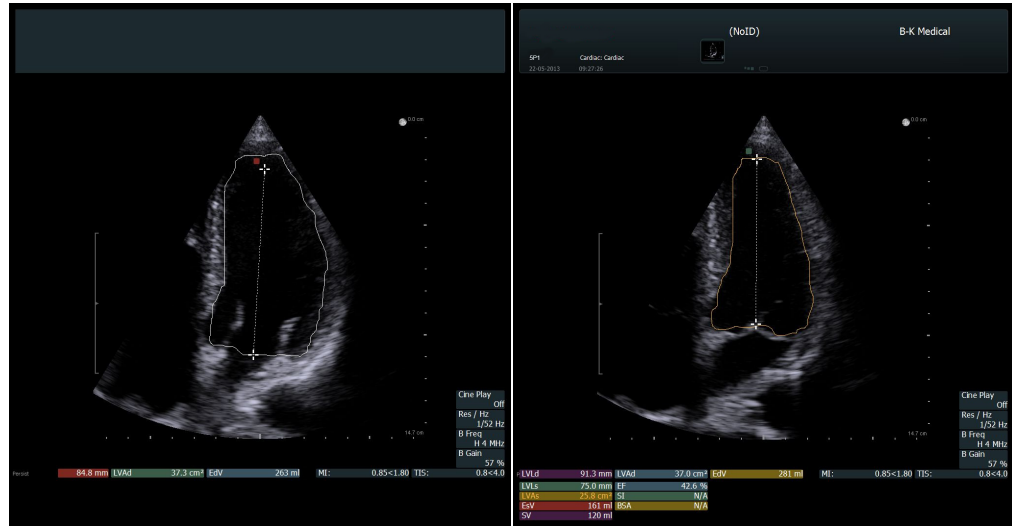

Figure 11-3. LV Diastole (left) and LV Systole (right).

NOTE: To remeasure, erase all measurements (long press on **Measure** key) and start the measurements again.

Doppler Measurements

PFV (Peak Flow Velocity):

- 1 Freeze Doppler spectrum.
- 2 Click tab for chosen valve, for example, **Aortic Valve**.
- 3 Click **PFV AV**.
- 4 Place cursor at peak velocity.
- 5 Click (press **Select**) to finish measurement.

System automatically calculates:

- PFV (Peak Flow Velocity) (cm/sec)
- PG (Pressure Gradient) (mm Hg)

VTI (Velocity Time Integral):

- 1 Freeze Doppler spectrum.
Measurement line appears.
- 2 Place line at beginning of Doppler waveform.
Another measurement line appears.
- 3 Place this line at the end of the Doppler waveform.
A cursor appears.
- 4 Place cursor at Doppler baseline at first line and use trackball to trace waveform to second line.
- 5 Click **Select** to finish the measurement.
- 6 System will automatically calculate:
 - ET (Ejection Time) (ms)
 - VTI (Velocity time Integral) (cm)

- PFV (Peak Flow Velocity) (cm/sec)
- PG (Pressure Gradient) (mm Hg)
- MPG (Mean Pressure Gradient) (mm Hg)

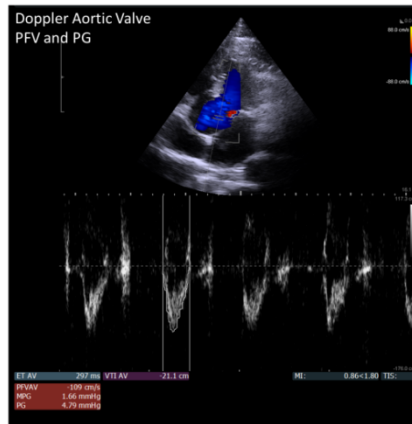

Figure 11-4. Doppler Aortic Valve PFV and PG measurements.

HR (Heart Rate)

In M-mode:

- 1 In advanced screen, freeze M Mode image. Click **LV** tab.
- 2 Click **HR (3)**. (You can choose **HR** keys to measure 1-10 beats: Click the right circle and choose from drop-down list.)
- 3 Place first cursor line at the beginning of a cardiac cycle (use the trackball) and click (press **Select**) to set its position.
- 4 Drag second cursor line to the end of the number of cycles you are measuring, (for example, three with HR (3)).

HR is displayed, averaged over the number of cycles you have selected.

In Doppler mode:

- On the **Measure and Mark** tab, click **Real Time**.
HR is displayed. It is averaged over 8 beats.

or

- Create a **Measurement D Mode** screen key using **Fn+C** on the keyboard: Select **HR** (with the desired number of beats to measure) and rename it.

Cardiac Output

- 1 Click **CO** (Cardiac Output) and measure the diameter for LVOT in B-mode.

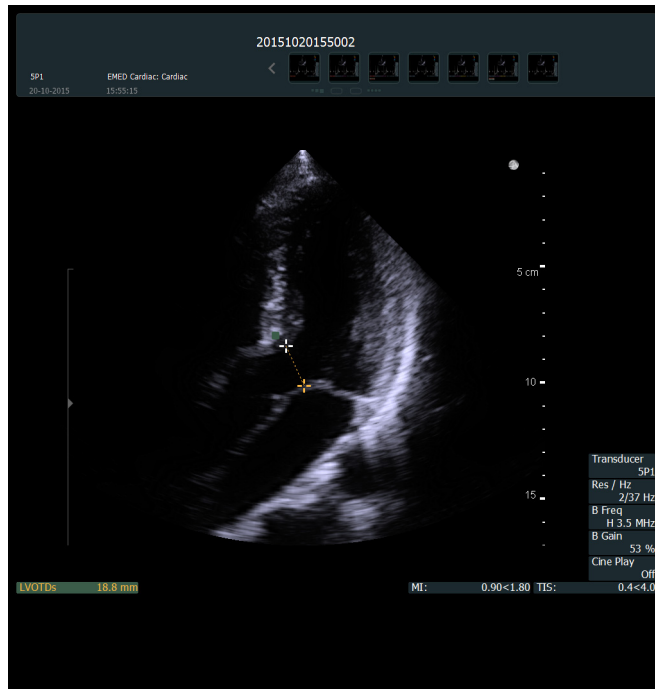

Figure 11-5. B-mode LVOT measurement.

- 2 Click **Color** and/or **Doppler**.
- 3 On the **LV** tab, click **CO**.

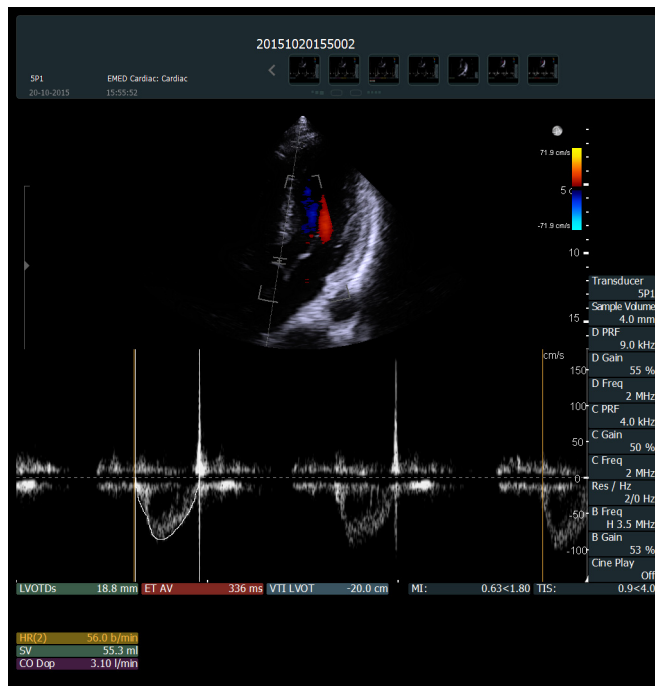

Figure 11-6. Cardiac Output measurement.

- 4 Measure the ET AV (Ejection Time Aorta Valve).
- 5 Measure the VTI LVOT (Velocity Time Integral Left Ventricle Outflow Tract).
- 6 Measure the HR over two cycles.
- 7 The CO measurement will show up labeled **CO Dop**.

Using Reports

Making and printing a report:

- 1 When you have finished making measurements, click on any thumbnail images you want in the report. They will appear on the second page of the report.
- 2 Click **Report** on the **Documentation** tab.
Comments put in the **Patient** window appear in the report.
You can type in up to 4 lines of remarks on the first page of the report.
- 3 Click **Print** to print the report before saving it.
- 4 Click **Save** (on the right, below the report) to save the report.

NOTE: Reports can be saved as documents or captured as images but cannot be printed directly from the thumbnails. In either case, open the thumbnail to print from the monitor.

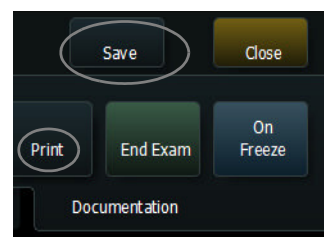

Figure 11-7. To **Save** or **Print** a report.

Capturing and Documenting Images

Cine Review

To use cine review:

- 1 Freeze image.
- 2 Turn **B-Mode** key to scroll back through imaging.

or

Click **Cine Play** on the right side of the monitor and press the **+/-** key to turn it on and off.

Capturing Images

Capturing Frozen Images

Saving (capturing) images to system hard disk:

- 1 Freeze the image.
- 2 Press **Capture** key on keyboard or click **Capture** on **Measure and Mark** tab.
Thumbnail of saved image appears in the document browser at the top of the monitor.

Capturing Clips (Unfrozen Images)

To capture clips:

- 1 Click **Capture** to start recording.
Capture control is red during recording.
- 2 Click **Capture** again to stop recording.
Thumbnail of image appears at top of monitor. (Play arrow is displayed on the thumbnail.)

Copying and Archiving

Copying or Archiving Images and Clips

To copy or archive images and clips:

- 1 Select thumbnail images.
- 2 On **Documentation** tab, select where to send the images.

Printing Images

Printing Images Displayed on the Monitor

To print an image displayed on the monitor:

- Press the **Print** key on the keyboard.

You can customize how the Print key works.

To specify which printer the key will print to:

- 1 Make sure the image is not frozen.
- 2 Click **Advanced**, then **Customize**.
- 3 Click the **Keys/Menus** tab and in the **Assignments** pane in the window, find **Print**.
- 4 Click **Print** and select a printer on the drop-down menu that appears.

A change in key assignment only affects the particular Pro Package that is selected in the left pane on the tab.

Printing from Thumbnail Images

To print thumbnail images (including archived ones) without opening them:

- 1 Click the thumbnails you want to print (to select them).
- 2 On the **Documentation** tab, click **Print**.
- 3 Click the printer you want on the drop-down menu that appears.
The images are printed.

To open a thumbnail image and then print it:

- 1 Double-click the thumbnail image to open it.
- 2 On the **Measure and Mark** tab, click **Print**.

The default setting is for a black and white USB printer.

To set a different printer as default for the Print screen key:

- 1 Press **Fn+C** on the keyboard.
- 2 Click the little circle that appears on the top left corner of the **Print** screen key.
- 3 Scroll through the list that appears and click the printer you want.
- 4 Click the **x** in the top right corner of the list menu to close the menu and save your changes.

See Appendix E, “Configuring the bk3000 and bk5000” for more details.

Customization Examples

Creating a Custom Keyboard Key for M-Mode

You may want to make a user-defined key so you can quickly access M-Mode.

To create a custom M-Mode key:

- 1 Make sure the image is not frozen.
- 2 Click **Advanced**, then **Customize**.
- 3 Click the **Keys/Menus** tab.
- 4 Select the key you want to use, for example, **P1**.
- 5 In the **Assignments** pane in the window, click **M-Mode**.
- 6 Click **Save** and **Close**.

Customizing Labels and Bodymarks Using Advanced Mode

Important: Save changes by going out of advanced screen (click **Advanced** so it is Off) and clicking **Save**.

Autocomplete labels:

Choose which labels you want to autocomplete as you type to save time.

- 1 Freeze the image.
- 2 Make sure that **Advanced** is On, then click **More Labels** to display a list of labels.
- 3 Select the ones you want to autocomplete by clicking the circle to the left of the label.

Now when you click **More Labels**, you will only get the shortened list that will autocomplete.

Quickly redefine a label/bodymark screen key:

- 1 Click on circle top right of screen key.
- 2 See a drop-down menu of possible choices.
- 3 Select the label or bodymark you want by clicking on the circle next to it in the list.

Keeping labels on screen when unfreezing image:

- 1 Make sure the image is not frozen.
- 2 Click **Advanced**, then **Customize**.
- 3 Click the **Labels/Marks** tab, and then, in the window that appears, the **Miscellaneous** tab.
- 4 Uncheck **Clear Labels on Unfreeze**.

FATE (Focus Assessed Transthoracic Echocardiography)

FATE is a form of specialized cardiac imaging for emergency medicine use, developed in Denmark.

Preset

For FATE, you use the **Cardiac FATE** preset in the Cardiac Pro Package. This preset has:

- Increased width for a quick overview
- M-mode measurements only

FATE Measurements

MSS (Mitral Septal Separation)

MSS is used as an M-mode echocardiographic indicator of normal or abnormal left ventricular ejection fraction.

Parasternal Long Axis View- M-Mode line through RV, IVS, MV end point

To measure:

- 1 In M-mode, click **Mitral Valve**.
- 2 Measure the distance between MV e-point and IVS in systole.
MSS calculation appears.

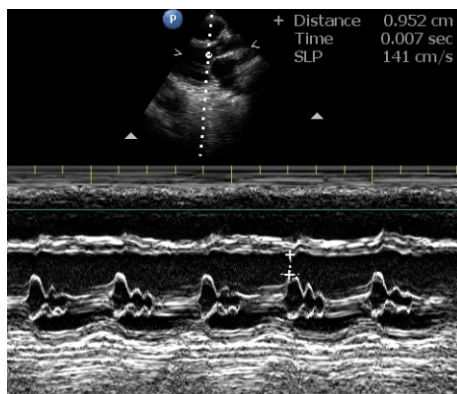

Figure 11-8. MSS measurement.

MAPSE Mitral Annular Plane Systolic Excursion

MAPSE is assessed with M-mode in apical four-chamber view, placing the M-mode beam on the lateral mitral annulus. Measurement takes place from the end of diastole, until maximal expansion in systole.

To measure MAPSE:

- 1 On the **Measure and Mark** tab, under **Mitral Valve**, click **MAPSE**.
- 2 Place the cross at the highest systolic excursion.
- 3 Click **MAPSE** again.
- 4 Place the next cross at the lowest diastolic excursion.

The vertical distance is now measured between the two crosses.

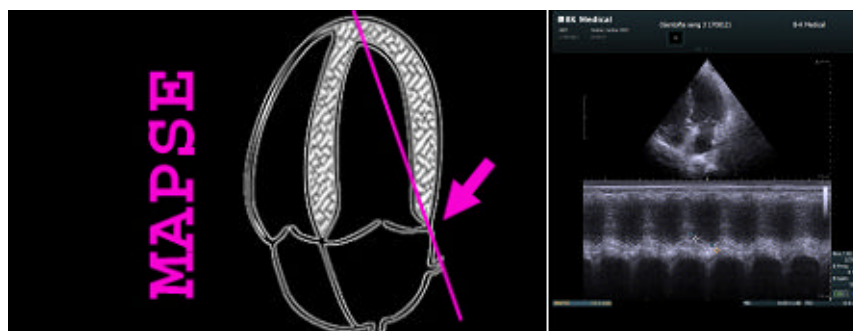

Figure 11-9. Measuring MAPSE in the FATE preset.

TAPSE Tricuspid Annular Plane Systolic Excursion

TAPSE can be assessed with M-mode, in the apical four-chamber view, placing the M-mode beam on the lateral Tricuspid annulus, measuring the distance of tricuspid annular movement between end diastole to end systole.

To measure TAPSE:

- 1 On the **Measure and Mark** tab, under **Tricuspid Valve**, click **TAPSE**.
- 2 Place the cross at the highest systolic excursion.
- 3 Click **TAPSE** again.
- 4 Place the next cross at the lowest diastolic excursion.

The vertical distance is now measured between the two crosses.

Where to Find More Information

For more information about different topics, you may want to refer to the following chapters:

- Layout of controls on the monitor and how to use the workflow tabs (Chapter 2, “The User Interface”).
- Names of screen controls and what they do (Chapter 3, “Controls on the Monitor”).
- Working with images (Chapter 4, “Working with the Image”).
- Making measurements (Chapter 5, “Making Measurements”).
- Documenting the image and results (Chapter 6, “Documentation”).
- Using different imaging modes (Chapter 7, “Imaging Modes”).
- List of all measurement abbreviations with full name (Appendix B, “Measurement Abbreviations”).
- Setting up and Customizing the System (including creating custom keys on the keyboard) (Appendix C, “Setting Up and Customizing Your System”).
- Redefining screen keys and configuring the appearance of on-screen information, keys, input fields, etc. (Appendix D, “Redefining Screen Keys – Label, Bodymark, and Measurement” and Appendix E, “Configuring the bk3000 and bk5000”).

The tables and formulas that the system uses for calculations are in the *Technical Data (BZ2100)* on the *User Documentation CD*.

Chapter 12

Urology Prostate Pro Package

This Pro Package contains information useful for basic urology imaging, including prostate imaging.

Important:

- Please see *Getting Started with bk3000 & bk5000* for basic controls.
- Read transducer user guides for more information before doing biopsies.
- Read *Care and Cleaning* for sterilization instructions.
- Read *bk3000 & bk5000 User Guide* before system use.

Contents

- Diagnostic Presets
- Setting up the Patient – Patient ID
- Imaging Controls
- Annotations – Labels and Bodymarks
- Measurements and Calculations
- User Reports
- Capturing and Documenting Images
- Customization Examples
- Links to Additional Information

Diagnostic Presets

Once you have selected your transducer, click the **Urology Prostate Pro Package** and select the appropriate preset. These will vary with each transducer.

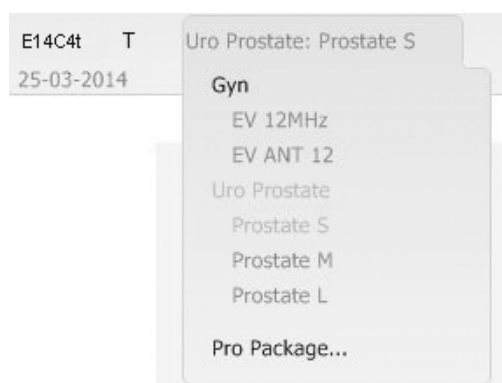

Triplane Prostate (E14C4t)

- Prostate Small = 12 Mhz.
- Prostate Medium = 9 Mhz.
- Prostate Large = 6 Mhz.

Figure 12-1. Preset drop-down menu.

Setting up the Patient – Patient ID

You must have a patient ID in order to save images.

- 1 Press **Patient** on the keyboard or click **Enter Patient** on the monitor.
- 2 Enter data in the **Patient** window.
- 3 Click **Start Exam** (below the **Patient** window).

NOTE: *It is recommended to enter the PSA (Prostate Specific Antigen) before you image. You can also enter PSA at the bottom of the screen.*



The screenshot shows a patient information form with the following fields:

Patient ID	20140729113141		Last Name	
First Name			Middle Name	
Accession Number			Birth Date	
Sex			Operator	
Perf. Physician			Ref. Physician	
Patient Comment				

Figure 12-2. Patient window

Imaging Controls

B Mode (2D)

Imaging starts in B-mode.

To return to imaging with B-mode alone after you have been using it in combination with other modes, press the **B-Mode** key on the keyboard.

Overall Gain:

- Adjust gain by *turning* the **B-Mode** key on the keyboard (when the image is not frozen) or clicking **Gain** on the monitor and selecting a value. You can also use the **+/-** key on the keyboard to change the value of the **Gain** screen key (slider).

Different gain at different image depths: adjusting the TGC curve:

- Move the **TGC** sliders on the keyboard to the right or left to adjust the TGC curve (differential gain).

The shape of the TGC curve is temporarily displayed to the right of the image as a curved vertical line.

Split Screen

Linked Split/Dual is enabled as a default setting on all Pro Packages. During split screen imaging, the Linked Split/Dual function automatically transfers screen-A image parameters to screen-B (and vice versa). Color and power mode can be in only one screen.

To use split screen:

- 1 To split the screen, press the **Split Screen** key on the keyboard. 
- 2 Image in screen-A.
- 3 Click screen-B to transfer the parameters from screen-A.
- 4 Freeze.
- 5 To go back to full screen, press the **Split Screen** key for more than 1 second.

To Change Transducer Planes

There are three ways to change transducer planes:

- 1 Press the **Plane** key on the keyboard to toggle through planes. 
- 2 Press the buttons on the transducer.
- 3 Click **Current Plane (T)** on the screen and select the desired plane from the drop down menu.





Biopsy

To display a puncture line on the image for biopsy guidance:

Press the **Biopsy** key on the keyboard:  or click **Biopsy** on the **Image** tab.

Remember to check that the needle guide number displayed on the monitor matches the number printed on the needle guide. To change the displayed needle guide, click the needle guide number on the screen for a drop down list of needle guides.

 <p>Verify transducer type number</p>	<p>WARNING P-w1</p> <p>Before you start imaging, verify that the type number of the transducer or the description of the puncture attachment you are using match the number displayed on the monitor. Also make sure that the needle guide is positioned correctly. If the numbers do not match, or the needle guide position is not correct, the puncture line on the monitor may not correspond to the true puncture path in the tissue. In case of any inconsistency, stop imaging, turn off the system, and contact your local BK Medical representative.</p>
--	--

 Verify puncture guide type number	WARNING P-w2 Verify that the type number of the puncture guide displayed on the monitor corresponds to the puncture guide that you are actually using. If the number is incorrect, the puncture line on the monitor may not correspond to the true puncture path in the tissue.
---	---

 Watch the needle tip	WARNING P-w4 The puncture line on the image is an indication of the expected needle path. The needle tip echo should be monitored at all times so any deviation from the desired path can be corrected.
--	---

NOTE: *If the image depth is set very low (to see tissue close to the transducer with high magnification), the needle tip echo can be outside the displayed image area. To see the needle tip in this case, zoom out so the full needle path is visible or pan the image to the side (to keep the high magnification).*

 Offset changes	WARNING P-w3 Changes you make to the offset of a programmable puncture guide or brachy matrix will affect ALL programmable puncture guides and brachy matrixes. This could lead to incorrect puncture lines or matrix positions for a different guide than the one you wanted to change.
--	--

Annotations – Labels and Bodymarks

Labels and bodymarks are activated from the **Measure and Mark** tab that appears when you freeze the image.

Labels

To select a label:

- 1 Make sure the image is frozen. On the **Measure and Mark** tab, click the label you want or click a label group (blue screen control) and then click the label (in the list that appears).
The label appears on the image.
- 2 Use the trackball to move the label and then click when it is in the correct position.

Type and edit your own labels on screen:

- 1 Type the text you want for the label.
You can move the label while you are typing it.
- 2 Click to accept the label text and position.

Customizing Labels and Bodymarks Using Advanced Mode

Important: Save changes by going out of advanced screen (click **Advanced** so it is Off) and clicking **Save**.

Autocomplete labels:

Choose which labels you want to autocomplete as you type to save time.

- 1 Freeze the image.
- 2 Make sure that **Advanced** is On, then click **More Labels** to display a list of labels.
- 3 Select the ones you want to autocomplete by clicking the circle to the left of the label.

Now when you click **More Labels**, you will only get the shortened list that will autocomplete.

Quickly redefine a label/bodymark screen key:

- 1 Click on circle top right of screen key.
- 2 See a drop-down menu of possible choices.
- 3 Select the label or bodymark you want by clicking on the circle next to it in the list.

Keeping labels on screen when unfreezing image:

- 1 Make sure the image is not frozen.
- 2 Click **Advanced**, then **Customize**.
- 3 Click the **Labels/Marks** tab, and then, in the window that appears, the **Miscellaneous** tab.
- 4 Uncheck **Clear Labels on Unfreeze**.

To move or edit a label:

- 1 To move a label that is on the image, click the label to select it, and use the trackball to move it.
- 2 To edit a label on the image, click the label (label turns blue).
- 3 Use backspace to move through the label and edit it. (You can also use the arrow keys on the keyboard to move the cursor while editing.)

To remove a label:

- Long click the label you want to remove (point at it and press the **Select** key for more than 1 second) or unfreeze.

As a default, the system erases all annotations on unfreeze

Aligning labels:

- **Horizontally:** Press the space bar on the keyboard after you type the label.
- **Vertically:** Press the **Return** key after you type the label.

Bodymarks

To place a bodymark on the image:

- 1 Freeze the image.
- 2 On the **Measure and Mark** tab, click the bodymark you want.
The bodymark appears on the monitor with an imaging plane indicator.
- 3 Drag and click the imaging plane indicator to position it; and use the +/- key to rotate it.
- 4 Click to set the position.

To move a bodymark:

- 1 Move the cursor to just outside the bodymark to select the bodymark frame (turns yellow).
- 2 Click to activate the bodymark outline (turns blue).
- 3 Drag it to the position you want, and click again to finish.

Setting default position:

- 1 Position bodymark on image.
- 2 Click **Advanced** and then click on circle on top right of bodymark.
- 3 Click **Settings...**
- 4 Click **Set as Default Position**.



Measurements and Calculations

Automatic Measurement of Prostate Volume

To measure prostate volume (width, height and length):

- 1 Freeze the image and click **Pr Vol.**.
The width (W) cursor appears automatically.
- 2 Position the first cursor and click.
- 3 Position the second cursor and click.
The height (H) cursor appears automatically.
- 4 Repeat measurement.
If you are not in simultaneous biplane mode, unfreeze the image and change transducer planes.
- 5 Click **Pr Vol.** again.
Length (L), the last set of measurements, appears automatically.
- 6 Repeat measurement.
- 7 When you have finished measuring, the volume calculation appears automatically.

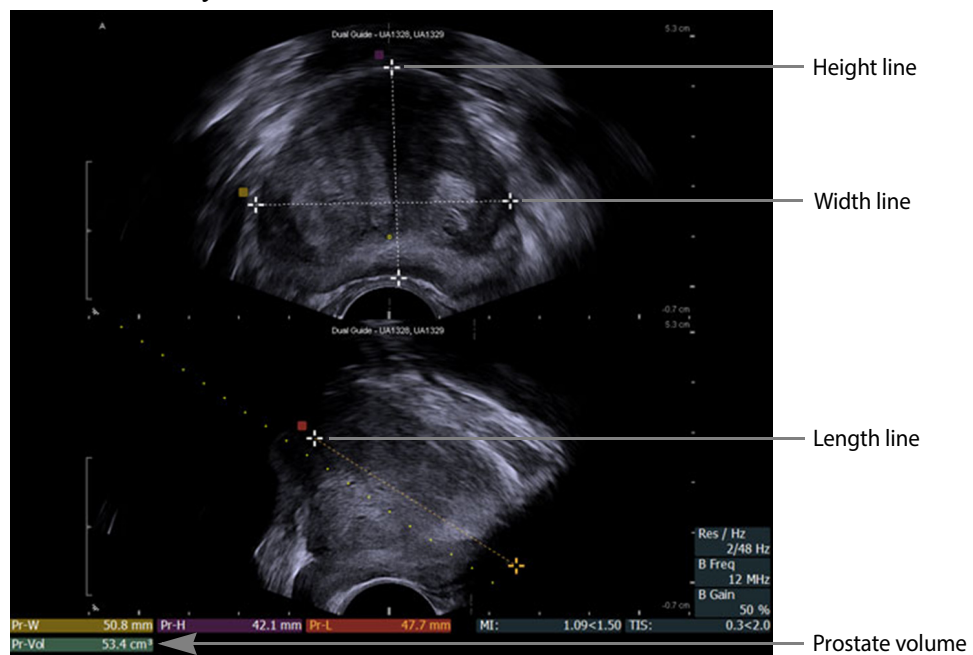



Figure 12-3. Prostate volume in split screen view

PSAD measurements:

The PSAD (Prostate Specific Antigen Density) will be calculated after the PSA has been entered and prostate volume has been measured.

NOTE: You can change the order of measurement from *WHL* to *LHW* by clicking **Vol LHW**.

To erase measurements:

- Press the **Measure**:  or the **Calculate** key:  for more than one second.
or
- Click on an individual measurement for more than one second.

User Reports

Making and printing a report:

- 1 When you have finished making measurements, click on any thumbnail images you want in the report. They will appear on the second page of the report.
- 2 Click **Report** on the **Documentation** tab.
Comments put in the **Patient** window appear in the report.
You can type in up to 4 lines of remarks on the first page of the report.
- 3 Click **Print** to print the report before saving it.
- 4 Click **Save** (on the right, below the report) to save the report.

NOTE: Reports can be saved as documents or captured as images but cannot be printed directly from the thumbnails. In either case, open the thumbnail to print from the monitor.

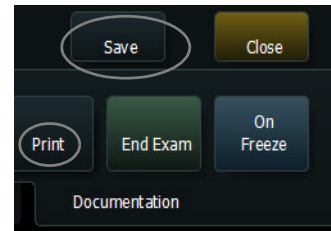

Capturing and Documenting Images

Cine Review

To use cine review:

- 1 Freeze image.
- 2 Turn **B-Mode** key to scroll back through imaging.
or
Click **Cine Play** on the right side of the monitor and press the **+/-** key to turn it on and off.

Capturing Images

Capturing Frozen Images

Saving (capturing) images to system hard disk:

- 1 Freeze the image.
- 2 Press **Capture** key on keyboard or click **Capture** on **Measure and Mark** tab.
Thumbnail of saved image appears in the document browser at the top of the monitor.

Capturing Clips (Unfrozen Images)

To capture clips:

- 1 Click **Capture** to start recording.
Capture control is red during recording.
- 2 Click **Capture** again to stop recording.
Thumbnail of image appears at top of monitor. (Play arrow is displayed on the thumbnail.)

Copying and Archiving

Copying or Archiving Images and Clips

To copy or archive images and clips:

- 1 Select thumbnail images.
- 2 On **Documentation** tab, select where to send the images.

Printing Images

Printing Images Displayed on the Monitor

To print an image displayed on the monitor:

- Press the **Print** key on the keyboard.

You can customize how the Print key works.

To specify which printer the key will print to:

- 1 Make sure the image is not frozen.
- 2 Click **Advanced**, then **Customize**.
- 3 Click the **Keys/Menus** tab and in the **Assignments** pane in the window, find **Print**.
- 4 Click **Print** and select a printer in the drop-down menu that appears.

A change in key assignment only affects the particular Pro Package that is selected in the left pane on the tab.

Printing from Thumbnail Images

To print thumbnail images (including archived ones) without opening them:

- 1 Click the thumbnails you want to print (to select them).
- 2 On the **Documentation** tab, click **Print**.
- 3 Click the printer you want from the drop-down menu that appears.
The images are printed.

To open a thumbnail image and then print it:

- 1 Double-click the thumbnail image to open it.
- 2 On the **Measure and Mark** tab, click **Print**.

The default setting is for a black and white USB printer.

To set a different printer as default for the Print screen key:

- 1 Click on the **Documentation** tab.
- 2 Press **Fn+C** on the keyboard.
- 3 Click the little circle that appears on the top left corner of the **Print** screen key.
- 4 Scroll through the list that appears and click the printer you want.
- 5 Click the **x** in the top right corner of the list menu to close the menu and save your changes.

See Appendix E, “Configuring the bk3000 and bk5000” for more details.

Customization Examples

New Presets

Saving a new preset:

- 1 Make sure image is not frozen.
- 2 Click **Advanced**.
- 3 Click **Save...**

The changed parameters are saved.

- 4 Name the new preset.
You can set it to be a default preset.

- 5 Click **Save**.
The new preset now appears under the Pro Package that you were using when you started to save the preset.

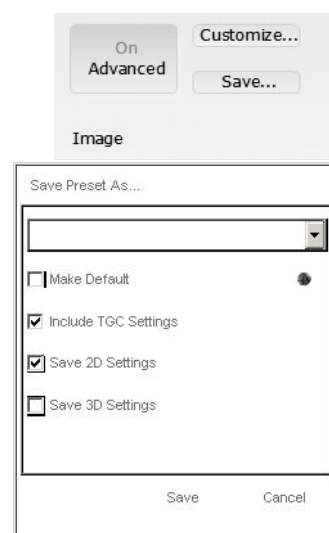

Figure 12-4. Saving a new preset

Default Pro Packages and Presets

You can change the default Pro Package and preset for a transducer.

Setting the default Pro Package and preset:

- 1 Activate the chosen transducer.
- 2 Make sure the image is not frozen, go to the **Image** tab and click **Advanced**.
- 3 Click **Customize**.
- 4 Click the **Pro/Setup** tab if it is not open.
- 5 In the table, scroll down the list of Pro Packages to find the one you want to set as default.

- 6 In this Pro Package, in the column for the chosen transducer, click the preset you want to be the default.
- 7 Click **Set Pro Package as Default** and **Set Preset as Default** (if you are changing both).
- 8 Click **Close**.

NOTE: *User-defined presets will not have an icon associated with them.*

Where to Find More Information

For more information about different topics, you may want to refer to the following chapters:

- Layout of controls on the monitor and how to use the workflow tabs (Chapter 2, “The User Interface”).
- Names of screen controls and what they do (Chapter 3, “Controls on the Monitor”).
- Working with images (Chapter 4, “Working with the Image”).
- Making measurements (Chapter 5, “Making Measurements”).
- Documenting the image and results (Chapter 6, “Documentation”).
- Using different imaging modes (Chapter 7, “Imaging Modes”).
- List of all measurement abbreviations with full name (Appendix B, “Measurement Abbreviations”).
- Setting up and Customizing the System (including creating custom keys on the keyboard) (Appendix C, “Setting Up and Customizing Your System”).
- Redefining screen keys and configuring the appearance of on-screen information, keys, input fields, etc. (Appendix D, “Redefining Screen Keys – Label, Bodymark, and Measurement” and Appendix E, “Configuring the bk3000 and bk5000”).

The tables and formulas that the system uses for calculations are in the *Technical Data (BZ2100)*.

Chapter 13

Surgery Pro Package

This chapter is valid for bk5000 only.

This Pro Package contains information useful for basic Surgery Imaging including:

- surgery measurements

Important:

- Read *Getting Started with bk3000 & bk5000* for basic controls.
- Read transducer user guides for more information before doing biopsies.
- Read *Care and Cleaning* for sterilization instructions.
- Read *bk3000 & bk5000 User Guide* before system use.

Contents

- Diagnostic Presets
- Setting up the Patient - Patient ID
- Imaging Controls
- Annotations - Labels and Bodymarks
- Measurements and Calculations
- Using Reports
- Capturing and Documenting Images
- Customization Examples
- Where to Find More Information

Diagnostic Presets

Once you have selected your transducer, click the **Surgery Pro Package** and select the appropriate preset. This will vary with the individual transducer.

If two or more transducers are connected, the system will always change to default preset/pro package when you change transducers.

Setting up the Patient – Patient ID

You must have a patient ID in order to save images.

- 1 Press **Patient** on keyboard or click **Enter Patient** on the monitor.
- 2 Enter data in the **Patient** window.
- 3 Click **Start Exam** (below the **Patient** window), or press the **Freeze** button on the keyboard.



The screenshot shows a patient information form with the following fields:

Patient ID	Last Name
20140729113141	
First Name	Middle Name
Accession Number	Birth Date
Sex	Operator
Perf. Physidan	Ref. Physician
Patient Comment	

Figure 13-1. Patient window

Imaging Controls

B-Mode (2D)

Imaging starts in B-mode.

To return to imaging with B-mode alone after you have been using it in combination with other modes, press the **B-Mode** key on the keyboard.

Overall Gain:

- Adjust gain by *turning* the **B-Mode** key on the keyboard (when the image is not frozen) or clicking **Gain** on the monitor and selecting a value. You can also use the **+/-** key on the keyboard to change the value of the **Gain** screen key (slider).

Different gain at different image depths: adjusting the TGC curve:

- Move the **TGC** sliders on the keyboard to the right or left to adjust the TGC curve (differential gain).

The shape of the TGC curve is temporarily displayed to the right of the image as a curved vertical line.

Split Screen

To use split screen:

- 1 To split the screen so you can see two images, press the **Split Screen** key on the keyboard.
- 2 Image and freeze.
- 3 Press **Split Screen** again, image in the second screen.
- 4 Freeze.
- 5 To go back to full screen, press the **Split Screen** key for more than 1 second.

Biopsy

To display a puncture line on the image for biopsy guidance:

- Press the **Biopsy** key on keyboard:  or click **Biopsy** on the **Image** tab.

(Remember to check that the needle guide number displayed on the monitor matches the number printed on the needle guide.)

 Verify transducer type number	WARNING P-w1 Before you start imaging, verify that the type number of the transducer or the description of the puncture attachment you are using match the number displayed on the monitor. Also make sure that the needle guide is positioned correctly. If the numbers do not match, or the needle guide position is not correct, the puncture line on the monitor may not correspond to the true puncture path in the tissue. In case of any inconsistency, stop imaging, turn off the system, and contact your local BK Medical representative.
--	---

 Verify puncture guide type number	WARNING P-w2 Verify that the type number of the puncture guide displayed on the monitor corresponds to the puncture guide that you are actually using. If the number is incorrect, the puncture line on the monitor may not correspond to the true puncture path in the tissue.
---	---

 Watch the needle tip	WARNING P-w4 The puncture line on the image is an indication of the expected needle path. The needle tip echo should be monitored at all times so any deviation from the desired path can be corrected.
--	---

NOTE: *If the image depth is set very low (to see tissue close to the transducer with high magnification), the needle tip echo can be outside the displayed image area. To see the needle tip in this case, zoom out so the full needle path is visible or pan the image to the side (to keep the high magnification).*

 Offset changes	WARNING P-w3 Changes you make to the offset of a programmable puncture guide or brachy matrix will affect ALL programmable puncture guides and brachy matrixes. This could lead to incorrect puncture lines or matrix positions for a different guide than the one you wanted to change.
--	--

Color Mode (CFM)

To use Color mode:

- 1 Press **Color Mode** key on keyboard, or click **Color** tab on monitor.
Color box is active (blue color) and can be moved with trackball.
- 2 To resize color box and keep default shape use **+ /-** key.
- 3 To change the shape (for example, narrow the width), click a corner of the box and drag the corner. Click when you are finished.

Color gain:

- Adjust color gain by *turning* **Color Mode** key or clicking **Gain** on monitor and selecting a value. You can also use the **+/-** key on the keyboard to change the value of the **Gain** screen key.

Scale

- Change PRF with **Scale** key on the keyboard or **Scale** screen key.

Doppler Mode

To use Doppler mode:

- 1 Press **Doppler Mode** key on keyboard, or click **Doppler** tab on monitor. Doppler sample gate is active (blue). Move with trackball.
- 2 Adjust size of Doppler gate with **+/-** key.
- 3 Adjust gain by turning **Doppler Mode** key or using the **Gain** screen control.
- 4 Press **Doppler Angle** key to activate the Doppler angle control, then adjust the angle with **+/-** key or trackball.
- 5 To adjust volume, PRF, baseline, sweep speed, use keys on keyboard or click **Advanced** on the **Doppler** tab to use screen controls.

Auto

Click **Auto** to have the system adjust baseline and PRF automatically. The adjustment requires a few vascular cycles before the adjustment is complete.

Elastography

See the section on Elastography in Chapter 7, “Imaging Modes” on page 88.

Annotations – Labels and Bodymarks

Labels and bodymarks are activated from the **Measure and Mark** tab that appears when you freeze the image.

NOTE: *When an annotation screen key is colored (different from the default color), it means that clicking it will cause a drop-down list to be displayed.*

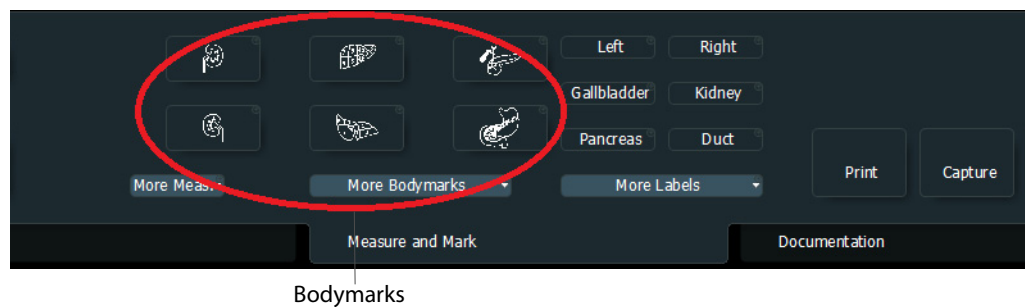

Figure 13-2. Measure and Mark tab in the Surgery Pro Package.

Labels

To select a label:

- 1 Make sure the image is frozen. On the **Measure and Mark** tab, click the label you want or click a label group (blue screen control) and then click the label (in the list that appears).
The label appears on the image.
- 2 Use the trackball to move the label and then click when it is in the correct position.

Type and edit your own labels on screen:

- 1 Type the text you want for the label.
You can move the label while you are typing it.
- 2 To accept the label text and position, click.

To move or edit a label:

- 1 To move a label that is on the image, click the label to select it, and use the trackball to move it.
- 2 To edit a label on the image, click the label (label turns blue).
- 3 Use backspace to move through the label and edit it. (You can also use the arrow keys on the keyboard to move the cursor while editing.)

To remove a label:

- Click (long) the label you want to remove (point at it and press the **Select** key for more than 1 second) or unfreeze.
As a default, the system erases all annotations on unfreeze

Default label position:

Unless you define a default position, a label is placed where the cursor is on the image.

To set a default position for system labels (labels that you click to select):

- 1 Position label on image.
- 2 Click **Advanced** and then click on circle on top right of label.
- 3 Click **Settings...**
- 4 Click **Set as Default Position**.

To set a default position for typed labels (labels that you type on the monitor):

- 1 Click on the image where you want the default label position to be.
- 2 In **Customize** (advanced unfrozen screen) click **Label**, then **Mark/Misc**.
- 3 Click **Always insert labels at default position**.
Typed labels will now always appear at the default position.

Aligning labels:

- **Horizontally:** Press the space bar on the keyboard after you type the label.
- **Vertically:** Press the **Return** key after you type the label.

Bodymarks

To place a bodymark on the image:

- 1 Freeze the image.
- 2 On the **Measure and Mark** tab, click the bodymark you want
The bodymark appears on the monitor with an imaging plane indicator.
- 3 Drag and click the imaging plane indicator to position it; and use the +/- key to rotate it.
- 4 Click to set the position.

To move a bodymark:

- 1 Click it or click near it, so that a frame around it turns blue.
- 2 Drag it to the position you want, and click again.

Setting default position:

- 1 Position bodymark on image.
- 2 Click **Advanced** and then click on circle on top right of bodymark.
- 3 Click **Settings...**
- 4 Click **Set as Default Position**.



Measurements and Calculations

Distance

To measure a distance:

- 1 Press the **Measure** key on the keyboard
or
on the **Measure and Mark** tab, click **Dist.**
- 2 Position the first cursor and click.
- 3 Position the second cursor and click.
Measurement is displayed on the monitor below the image.
- 4 For multiple measurements, repeat the steps.

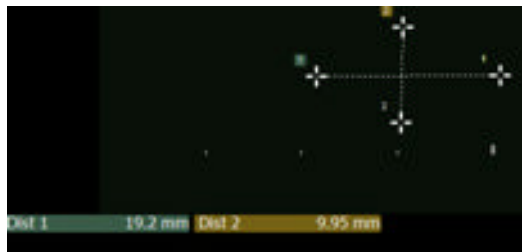

Freehand Measurements – Area and Circumference

To measure the area and circumference:

- 1 On the **Measure and Mark** tab, click **Freehand**.

- 2 Move the marker to the start position and click.
- 3 Use the trackball to move the marker to trace the desired area.
- 4 Click when you are finished (back at the starting point).
Area and circumference are calculated and displayed on the monitor below the image.

Volume

When you calculate volume using this method, the height, width, and length measurements must all be made at right angles to each other. Therefore, you must use 2 images to measure volume.

To calculate a volume:

- 1 On the **Measure and Mark** tab, click **Volume**.
A marker appears to use for measuring **Width**.
- 2 Use the trackball to move the marker to the start position and click.
- 3 Position the second marker and click to finish the **Width** measurement.
- 4 Unfreeze and change imaging plane. Freeze image.
- 5 Repeat the first steps (clicking **Volume** each time) to measure **Height** and **Length**.
- 6 **Volume** is calculated and displayed.

Using Reports

Making and printing a report:

- 1 When you have finished making measurements, click on any thumbnail images you want in the report. They will appear on the second page of the report.
- 2 Click **Report** on the **Documentation** tab.
Comments put in the **Patient** window appear in the report.
You can type in up to 4 lines of remarks on the first page of the report.
- 3 Click **Print** to print the report before saving it.
- 4 Click **Save** (on the right, below the report) to save the report.

NOTE: Reports can be saved as documents or captured as images but cannot be printed directly from the thumbnails. In either case, open the thumbnail to print from the monitor.

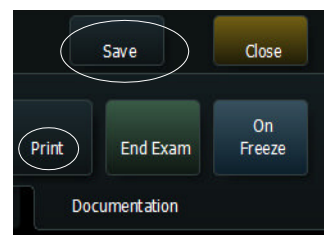

Capturing and Documenting Images

Cine Review

To use cine review:

- 1 Freeze image.

- 2 Turn **B-Mode** key to scroll back through imaging.
or
Click **Cine Play** on the right side of the monitor and press the **+/-** key to turn it on and off.

The Document Browser

Captured images are displayed as thumbnails in the document browser at the top of the monitor.

Using the document browser:

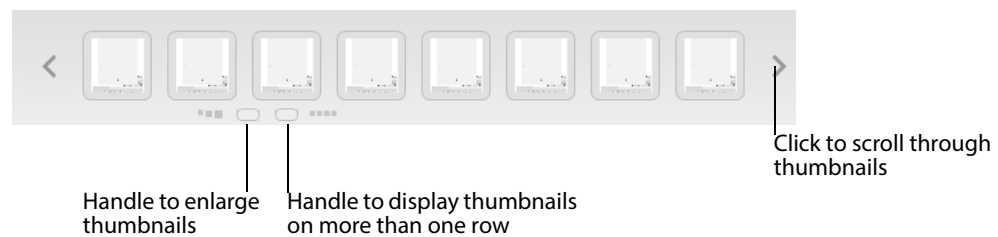

Figure 13-3. The handles and scroll arrows in the document browser.

Capturing Images

Capturing Frozen Images

Saving (capturing) images to system hard disk:

- 1 Freeze the image.
- 2 Press **Capture** key on keyboard or click **Capture** on **Measure and Mark** tab.
Thumbnail of saved image appears in the document browser at the top of the monitor.

Capturing Clips (Unfrozen Images)

To capture clips:

- 1 Click **Capture** to start recording.
Capture control is red during recording.
- 2 Click **Capture** again to stop recording.
Thumbnail of image appears at top of monitor. (Play arrow is displayed on the thumbnail.)

Copying and Archiving

Copying or Archiving Images and Clips

To copy or archive images and clips:

- 1 Select thumbnail images.
- 2 On **Documentation** tab, select where to send the images.

Printing Images

Printing Images Displayed on the Monitor

To print an image displayed on the monitor:

- Press the **Print** key on the keyboard.

You can customize how the Print key works.

To specify which printer the key will print to:

- 1 Make sure the image is not frozen.
- 2 Click **Advanced**, then **Customize**.
- 3 Click the **Keys/Menus** tab and in the **Assignments** pane in the window, find **Print**.
- 4 Click **Print** and select a printer in the drop-down menu that appears.

A change in key assignment only affects the particular Pro Package that is selected in the left pane on the tab.

Printing from Thumbnail Images

To print thumbnail images (including archived ones) without opening them:

- 1 Click the thumbnails you want to print (to select them).
- 2 On the **Documentation** tab, click **Print**.
- 3 Click the printer you want from the dropdown list that appears.
The images are printed.

To open a thumbnail image and then print it:

- 1 Double-click the thumbnail image to open it.
- 2 On the **Measure and Mark** tab, click **Print**.
The default setting is for a black and white USB printer.

To set a different printer as default for the Print screen key:

- 1 Press **Fn+C** on the keyboard.
- 2 Click the little circle that appears on the top left corner of the **Print** screen key.
- 3 Scroll through the list that appears and click the printer you want.
- 4 Click the **x** in the top right corner of the list menu to close the menu and save your changes.

See Appendix E, “Configuring the bk3000 and bk5000” on page 293 for more details.

Customization Examples

New Presets

Saving a new preset:

- 1 Make sure image is not frozen.
- 2 Click **Advanced**.
- 3 Click **Save...**
The changed parameters are saved.
- 4 Name the new preset.
You can set it to be a default preset.
- 5 Click **Save**.
The new preset now appears under the Pro Package that you were using when you started to save the preset.

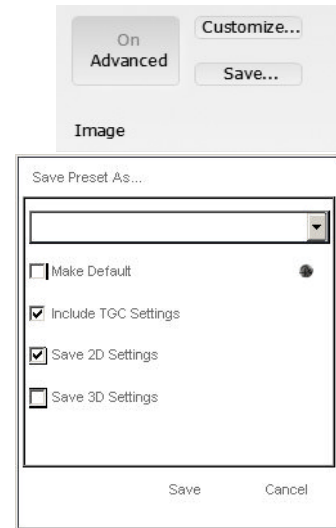

Default Pro Packages and Presets

You can change the default Pro Package and preset for a transducer.

Setting the default Pro Package and preset:

- 1 Activate the chosen transducer.
- 2 Make sure the image is not frozen, go to the **Image** tab and click **Advanced**.
- 3 Click **Customize**.
- 4 Click the **Pro/Setup** tab if it is not open.
- 5 In the table, scroll down the list of Pro Packages to find the one you want to set as default.
- 6 In this Pro Package, in the column for the chosen transducer, click the preset you want to be the default.
- 7 Click **Set Pro Package as Default** and **Set Preset as Default** (if you are changing both).
- 8 Click **Close**.

NOTE: *User-defined presets will not have an icon associated with them.*

Making a New Screen Key

To make a new screen key:

- 1 Press **Fn+C** and click on available space (one with little circles)



- 2 Select the key name (for example, **Labels clear all**) from the drop-down list that appears.
- 3 Press **Fn+C** to save your new configuration and leave Configuration Mode.

Customizing Labels and Bodymarks Using Advanced Mode

Important: Save changes by going out of advanced screen (click **Advanced** so it is Off) and clicking **Save**.

Autocomplete labels:

Choose which labels you want to autocomplete as you type to save time.

- 1 Freeze the image.
- 2 Make sure that **Advanced** is On, then click **More Labels** to display a list of labels.
- 3 Select the ones you want to autocomplete by clicking the circle to the left of the label.

Now when you click **More Labels**, you will only get the shortened list that will autocomplete.

Quickly redefine a label/bodymark screen key:

- 1 Click on circle top right of screen key.
- 2 See a drop-down list of possible choices.
- 3 Select the label or bodymark you want by clicking on the circle next to it in the list.

Keeping labels on screen when unfreezing image:

- 1 Make sure the image is not frozen.
- 2 Click **Advanced**, then **Customize**.
- 3 Click the **Labels/Marks** tab, and then, in the window that appears, the **Miscellaneous** tab.
- 4 Uncheck **Clear Labels on Unfreeze**.

Where to Find More Information

Before reading about the Pro Packages, you should already be familiar with the system, but for more information about different topics, you may want to refer to the following chapters:

- Layout of controls on the monitor and how to use the workflow tabs (Chapter 2, “The User Interface”)
- Names of screen controls and what they do (Chapter 3, “Controls on the Monitor”)
- Working with images (Chapter 4, “Working with the Image”)
- Making measurements (Chapter 5, “Making Measurements”)
- Documenting the image and results (Chapter 6, “Documentation”)
- Using different imaging modes (Chapter 7, “Imaging Modes”)
- List of all measurement abbreviations with full name (Appendix B, “Measurement Abbreviations”)
- Setting up and Customizing the System (including creating custom keys on the keyboard) (Appendix C, “Setting Up and Customizing Your System”)
- Redefining screen keys and configuring the appearance of on-screen information, keys, input fields, etc. (Appendix D, “Redefining Screen Keys – Label, Bodymark, and Measurement” and Appendix E, “Configuring the bk3000 and bk5000”)

The tables and formulas that the system uses for calculations are in the *Technical Data (BZ2100)*

Chapter 14

Neuro Pro Package

This chapter is valid for bk5000 only.

This Pro Package contains information useful for basic brain imaging including:

- Burr-hole imaging (N11C5s¹ transducer)
- Craniotomy imaging (N13C5¹ transducer)

Important:

Please see *Getting Started with bk3000 & bk5000* for basic controls.

Read transducer user guides for more information before doing biopsies.

Read *Care and Cleaning* for sterilization instructions.

Read *bk3000 & bk5000 User Guide* before system use.

Contents

- Diagnostic Presets
- Setting up the Patient – Patient ID
- Imaging Controls
- Annotations – Labels and Bodymarks
- Measurements and Calculations
- Using Reports
- Capturing and Documenting Images
- Customization Examples
- Links to Additional Information

Diagnostic Presets

Once you have selected your transducer, click the **Neuro Pro Package** and select the appropriate preset. This will vary with each transducer.

Burr-hole transducer (N11C5s)

Craniotomy transducer (N13C5)

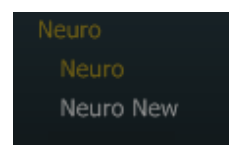

If two or more transducers are connected, the system will always change to default preset/pro package when you change transducers.

1. The N11C5s and N13C5 transducers have not been licensed by Health Canada for bk5000.

Setting up the Patient – Patient ID

You must have a patient ID in order to save images.

- 1 Press **Patient** on keyboard or click **Enter Patient** on the monitor.
- 2 Enter data in the **Patient** window.
- 3 Click **Start Exam** (below the **Patient** window).

20140729113141	
First Name	Middle
Accession Number	Birth D
Sex	Operat
Perf. Physician	Ref. Pl
Patient Comment	

Imaging Controls

B Mode (2D)

Imaging starts in B-mode.

To return to imaging with B-mode alone after you have been using it in combination with other modes, press the **B-Mode** key on the keyboard.

Overall Gain:

- Adjust gain by *turning* the **B-Mode** key on the keyboard (when the image is not frozen) or clicking **Gain** on the monitor and selecting a value. You can also use the **+/-** key on the keyboard to change the value of the **Gain** screen key (slider).

Different gain at different image depths: adjusting the TGC curve:

- Move the **TGC** sliders on the keyboard to the right or left to adjust the TGC curve (differential gain).

The shape of the TGC curve is temporarily displayed to the right of the image as a curved vertical line.

Split Screen

To use split screen:

- 1 To split the screen so you can see two images, press the **Split Screen** key on the keyboard.
- 2 Image and freeze.
- 3 Press **Split Screen** again, image in the second screen.
- 4 Freeze.
- 5 To go back to full screen, press the **Split Screen** key for more than 1 second.

Biopsy

To display a puncture line on the image for biopsy guidance:

- Press the **Biopsy** key on keyboard:  or click **Biopsy** on the **Image** tab.

(Remember to check that the needle guide number displayed on the monitor matches the number printed on the needle guide.)

 Verify transducer type number	WARNING P-w1 Before you start imaging, verify that the type number of the transducer or the description of the puncture attachment you are using match the number displayed on the monitor. Also make sure that the needle guide is positioned correctly. If the numbers do not match, or the needle guide position is not correct, the puncture line on the monitor may not correspond to the true puncture path in the tissue. In case of any inconsistency, stop imaging, turn off the system, and contact your local BK Medical representative.
--	---

 Verify puncture guide type number	WARNING P-w2 Verify that the type number of the puncture guide displayed on the monitor corresponds to the puncture guide that you are actually using. If the number is incorrect, the puncture line on the monitor may not correspond to the true puncture path in the tissue.
---	---

 Watch the needle tip	WARNING P-w4 The puncture line on the image is an indication of the expected needle path. The needle tip echo should be monitored at all times so any deviation from the desired path can be corrected.
--	---

NOTE: *If the image depth is set very low (to see tissue close to the transducer with high magnification), the needle tip echo can be outside the displayed image area. To see the needle tip in this case, zoom out so the full needle path is visible or pan the image to the side (to keep the high magnification).*

 Offset changes	WARNING P-w3 Changes you make to the offset of a programmable puncture guide or brachy matrix will affect ALL programmable puncture guides and brachy matrixes. This could lead to incorrect puncture lines or matrix positions for a different guide than the one you wanted to change.
--	--

Color Mode (CFM)

To use Color mode:

- 1 Press **Color Mode** key on keyboard, or click **Color** tab on monitor.
Color box is active (blue color) and can be moved with trackball.
- 2 To resize color box and keep default shape use **+ /-** key.
- 3 To change the shape (for example, narrow the width), click a corner of the box and drag the corner. Click when you are finished.

Color gain:

- Adjust color gain by *turning* **Color Mode** key or clicking **Gain** on monitor and selecting a value. You can also use the **+/-** key on the keyboard to change the value of the **Gain** screen key.

Scale

- Change PRF with **Scale** key on the keyboard or **Scale** screen key.

Doppler Mode

To use Doppler mode:

- 1 Press **Doppler Mode** key on keyboard, or click **Doppler** tab on monitor. Doppler sample gate is active (blue). Move with trackball.
- 2 Adjust size of Doppler gate with **+/-** key.
- 3 Adjust gain by turning **Doppler Mode** key or using the **Gain** screen control.
- 4 Press **Doppler Angle** key to activate the Doppler angle control, then adjust the angle with **+/-** key or trackball.
- 5 To adjust volume, PRF, baseline, sweep speed, use keys on keyboard or click **Advanced** on the **Doppler** tab to use screen controls.

Auto

Click **Auto** to have the system adjust baseline and PRF automatically. The adjustment requires a few vascular cycles before the adjustment is complete.

Elastography

See the section on Elastography in Chapter 7, “Imaging Modes” on page 88.

Annotations – Labels and Bodymarks

Labels and bodymarks are activated from the **Measure and Mark** tab that appears when you freeze the image.

NOTE: *When an annotation screen key is colored (different from the default color), it means that clicking it will cause a drop-down list to be displayed.*

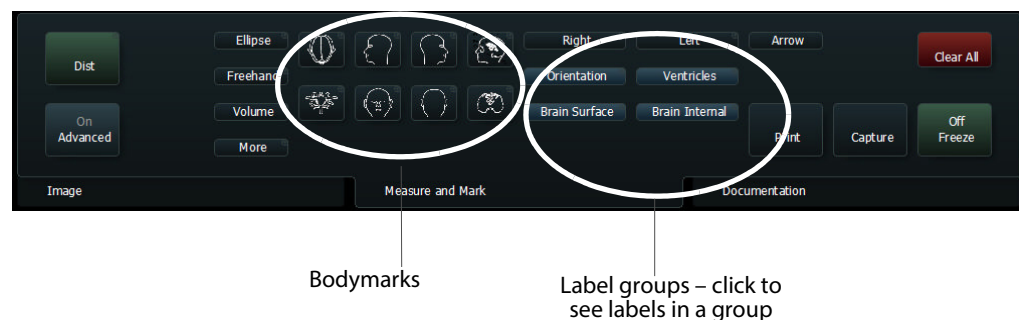

Figure 14-1. Measure and Mark tab in the Neuro Pro Package.

Labels

Existing labels are grouped, with a screen key for each group.

To select a label:

- 1 Make sure the image is frozen. On the **Measure and Mark** tab, click the label you want or click a label group (blue screen control) and then click the label (in the list that appears).
The label appears on the image.
- 2 Use the trackball to move the label and then click when it is in the correct position.

Type and edit your own labels on screen:

- 1 Type the text you want for the label.
You can move the label while you are typing it.
- 2 To accept the label text and position, click.

To move or edit a label:

- 1 To move a label that is on the image, click the label to select it, and use the trackball to move it.
- 2 To edit a label on the image, click the label (label turns blue).
- 3 Use backspace to move through the label and edit it. (You can also use the arrow keys on the keyboard to move the cursor while editing.)

To remove a label:

- Click (long) the label you want to remove (point at it and press the **Select** key for more than 1 second) or unfreeze.
As a default, the system erases all annotations on unfreeze

Default label position:

Unless you define a default position, a label is placed where the cursor is on the image.

To set a default position for system labels (labels that you click to select):

- 1 Position label on image.
- 2 Click **Advanced** and then click on circle on top right of label.
- 3 Click **Settings...**
- 4 Click **Set as Default Position**.

To set a default position for typed labels (labels that you type on the monitor):

- 1 Click on the image where you want the default label position to be.
- 2 In **Customize** (advanced unfrozen screen) click **Label**, then **Mark/Misc**.
- 3 Click **Always insert labels at default position**.
Typed labels will now always appear at the default position.

Aligning labels:

- **Horizontally:** Press the space bar on the keyboard after you type the label.
- **Vertically:** Press the **Return** key after you type the label.

Bodymarks

The following bodymarks are available in the Neuro Pro Package:









	Circle of Willis		Sagittal Head with Ventricles
	Coronal Brain		Sagittal Right Head
	Frontal Head		Sagittal Left Head
	Posterior Head		Vertex

Figure 14-2. Neuro bodymarks.

To place a bodymark on the image:

- 1 Freeze the image.
- 2 On the **Measure and Mark** tab, click the bodymark you want
The bodymark appears on the monitor with an imaging plane indicator.
- 3 Drag and click the imaging plane indicator to position it; and use the **+/-** key to rotate it.
- 4 Click to set the position.

To move a bodymark:

- 1 Click it or click near it, so that a frame around it turns blue.
- 2 Drag it to the position you want, and click again.

Setting default position:

- 1 Position bodymark on image.
- 2 Click **Advanced** and then click on circle on top right of bodymark.
- 3 Click **Settings...**
- 4 Click **Set as Default Position**.



Measurements and Calculations

Distance

To measure a distance:

- 1 Press the **Measure** key on the keyboard
or
on the **Measure and Mark** tab, click **Dist.**
- 2 Position the first cursor and click.
- 3 Position the second cursor and click.
Measurement is displayed on the monitor below the image.
- 4 For multiple measurements, repeat the steps.

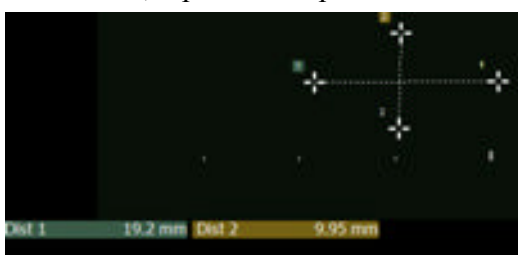

Freehand Measurements – Area and Circumference

To measure the area and circumference:

- 1 On the **Measure and Mark** tab, click **Freehand**.
- 2 Move the marker to the start position and click.
- 3 Use the trackball to move the marker to trace the desired area.
- 4 Click when you are finished (back at the starting point).
Area and circumference are calculated and displayed on the monitor below the image.

Volume

When you calculate volume using this method, the height, width, and length measurements must all be made at right angles to each other. Therefore, you must use 2 images to measure volume.

To calculate a volume:

- 1 On the **Measure and Mark** tab, click **Volume**.
A marker appears to use for measuring **Width**.
- 2 Use the trackball to move the marker to the start position and click.
- 3 Position the second marker and click to finish the **Width** measurement.
- 4 Unfreeze and change imaging plane. Freeze image.
- 5 Repeat the first steps (clicking **Volume** each time) to measure **Height** and **Length**.
- 6 **Volume** is calculated and displayed.

Using Reports

Making and printing a report:

- 1 When you have finished making measurements, click on any thumbnail images you want in the report. They will appear on the second page of the report.
- 2 Click **Report** on the **Documentation** tab.
Comments put in the **Patient** window appear in the report.
You can type in up to 4 lines of remarks on the first page of the report.
- 3 Click **Print** to print the report before saving it.
- 4 Click **Save** (on the right, below the report) to save the report.

NOTE: Reports can be saved as documents or captured as images but cannot be printed directly from the thumbnails. In either case, open the thumbnail to print from the monitor.

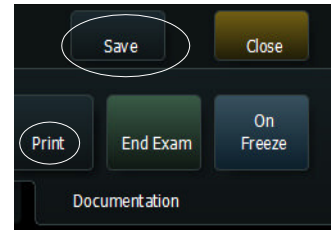

Capturing and Documenting Images

Cine Review

To use cine review:

- 1 Freeze image.
 - 2 Turn **B-Mode** key to scroll back through imaging.
- or

Click **Cine Play** on the right side of the monitor and press the **+/-** key to turn it on and off.

The Document Browser

Captured images are displayed as thumbnails in the document browser at the top of the monitor.

Using the document browser:

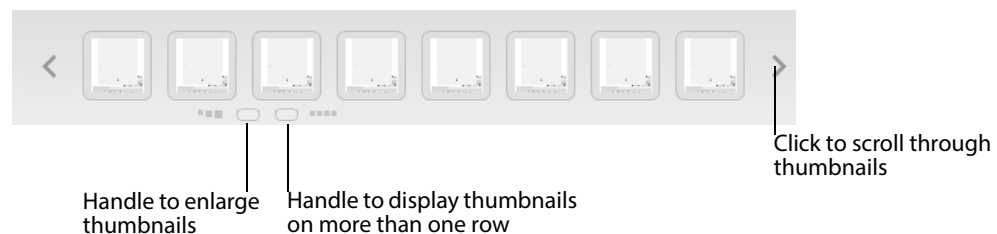

Figure 14-3. The handles and scroll arrows in the document browser.

Capturing Images

Capturing Frozen Images

Saving (capturing) images to system hard disk:

- 1 Freeze the image.
- 2 Press **Capture** key on keyboard or click **Capture** on **Measure and Mark** tab. Thumbnail of saved image appears in the document browser at the top of the monitor.

Capturing Clips (Unfrozen Images)

To capture clips:

- 1 Click **Capture** to start recording.
Capture control is red during recording.
- 2 Click **Capture** again to stop recording.
Thumbnail of image appears at top of monitor. (Play arrow is displayed on the thumbnail.)

Copying and Archiving

Copying or Archiving Images and Clips

To copy or archive images and clips:

- 1 Select thumbnail images.
- 2 On **Documentation** tab, select where to send the images.

Printing Images

Printing Images Displayed on the Monitor

To print an image displayed on the monitor:

- Press the **Print** key on the keyboard.

You can customize how the Print key works.

To specify which printer the key will print to:

- 1 Make sure the image is not frozen.
- 2 Click **Advanced**, then **Customize**.
- 3 Click the **Keys/Menus** tab and in the **Assignments** pane in the window, find **Print**.
- 4 Click **Print** and select a printer in the drop-down menu that appears.

A change in key assignment only affects the particular Pro Package that is selected in the left pane on the tab.

Printing from Thumbnail Images

To print thumbnail images (including archived ones) without opening them:

- 1 Click the thumbnails you want to print (to select them).
- 2 On the **Documentation** tab, click **Print**.
- 3 Click the printer you want from the dropdown list that appears.
The images are printed.

To open a thumbnail image and then print it:

- 1 Double-click the thumbnail image to open it.
- 2 On the **Measure and Mark** tab, click **Print**.
The default setting is for a black and white USB printer.

To set a different printer as default for the Print screen key:

- 1 Press **Fn+C** on the keyboard.
- 2 Click the little circle that appears on the top left corner of the **Print** screen key.
- 3 Scroll through the list that appears and click the printer you want.
- 4 Click the **x** in the top right corner of the list menu to close the menu and save your changes.

See Appendix E, “Configuring the bk3000 and bk5000” for more details.

Customization Examples

New Presets

Saving a new preset:

- 1 Make sure image is not frozen.
- 2 Click **Advanced**.
- 3 Click **Save...**
The changed parameters are saved.
- 4 Name the new preset.
You can set it to be a default preset.
- 5 Click **Save**.
The new preset now appears under the Pro Package that you were using when you started to save the preset.

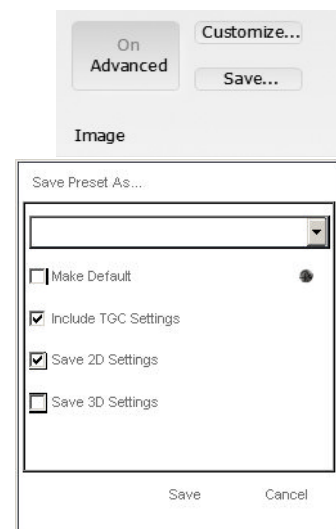

Default Pro Packages and Presets

You can change the default Pro Package and preset for a transducer.

Setting the default Pro Package and preset:

- 1 Activate the chosen transducer.
- 2 Make sure the image is not frozen, go to the **Image** tab and click **Advanced**.
- 3 Click **Customize**.
- 4 Click the **Pro/Setup** tab if it is not open.
- 5 In the table, scroll down the list of Pro Packages to find the one you want to set as default.
- 6 In this Pro Package, in the column for the chosen transducer, click the preset you want to be the default.
- 7 Click **Set Pro Package as Default** and **Set Preset as Default** (if you are changing both).
- 8 Click **Close**.

NOTE: User-defined presets will not have an icon associated with them.

Making a New Screen Key

To make a new screen key:

- 1 Press **Fn+C** and click on available space (one with little circles)

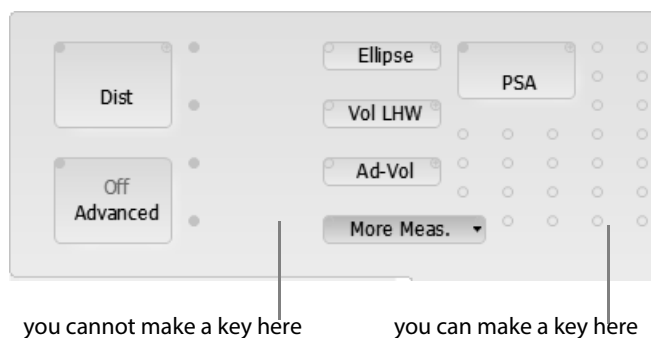

- 2 Select the key name (for example, **Labels clear all**) from the drop-down list that appears.
- 3 Press **Fn+C** to save your new configuration and leave Configuration Mode.

Customizing Labels and Bodymarks Using Advanced Mode

Important: Save changes by going out of advanced screen (click **Advanced** so it is Off) and clicking **Save**.

Autocomplete labels:

Choose which labels you want to autocomplete as you type to save time.

- 1 Freeze the image.
- 2 Make sure that **Advanced** is On, then click **More Labels** to display a list of labels.
- 3 Select the ones you want to autocomplete by clicking the circle to the left of the label.

Now when you click **More Labels**, you will only get the shortened list that will autocomplete.

Quickly redefine a label/bodymark screen key:

- 1 Click on circle top right of screen key.
- 2 See a drop-down list of possible choices.
- 3 Select the label or bodymark you want by clicking on the circle next to it in the list.

Keeping labels on screen when unfreezing image:

- 1 Make sure the image is not frozen.
- 2 Click **Advanced**, then **Customize**.
- 3 Click the **Labels/Marks** tab, and then, in the window that appears, the **Miscellaneous** tab.
- 4 Uncheck **Clear Labels on Unfreeze**.

Where to Find More Information

Before reading about the Pro Packages, you should already be familiar with the system, but for more information about different topics, you may want to refer to the following chapters:

- Layout of controls on the monitor and how to use the workflow tabs (Chapter 2, “The User Interface”)
- Names of screen controls and what they do (Chapter 3, “Controls on the Monitor”)
- Working with images (Chapter 4, “Working with the Image”)
- Making measurements (Chapter 5, “Making Measurements”)
- Documenting the image and results (Chapter 6, “Documentation”)
- Using different imaging modes (Chapter 7, “Imaging Modes”)
- List of all measurement abbreviations with full name (Appendix B, “Measurement Abbreviations”)
- Setting up and Customizing the System (including creating custom keys on the keyboard) (Appendix C, “Setting Up and Customizing Your System”)
- Redefining screen keys and configuring the appearance of on-screen information, keys, input fields, etc. (Appendix D, “Redefining Screen Keys – Label, Bodymark, and Measurement” and Appendix E, “Configuring the bk3000 and bk5000”)

The tables and formulas that the system uses for calculations are in the *Technical Data (BZ2100)*.

Chapter 15

3D Imaging

Introduction to 3D Ultrasound

The basic concept of 3D¹ ultrasound is to collect a data set of 2D ultrasound images (black & white or color) while tracking and storing the location of each individual 2D image. The data set is then reconstructed into a single 3D volume that can be displayed on the monitor and manipulated. The reconstructed 3D volume can be rotated, sliced, rendered, or displayed in multiplane cross-sections.

Imaging Modes

On bk3000 and bk5000, you can use 3D with B-mode, Color mode, or Power mode imaging. However, you cannot use 3D with the following modes and functions:

- Doppler mode (spectral PW Doppler)
- M-mode
- Color mode using Velocity submodule
- B Color

NOTE: *Turning on one of these modes or functions while you are using 3D will turn off 3D. If you are already using one of these modes, turning on 3D will turn the mode or function off, and turning off 3D will not turn it on again.*

NOTE: *Acquiring a 3D volume with some color maps may result in faulty colors for some pixels. To avoid this, the system selects a default pure grayscale instead.*

Making measurements on a 3D cube is not the same as making measurements on a 2D image, as described in Chapter 5, “Making Measurements”.

3D License

The 3D function of the bk3000 and bk5000 can be purchased as an option. For more information, see the bk3000 and bk5000 Product Data sheets that accompany this user guide.

To run the 3D software, you must have a license from BK Medical. For information about activating the 3D option, see “Licenses” on page 282.

Password Protection

If your patient archiving system is password protected (see page 66), you cannot use the 3D system unless you are logged in.

In an emergency, you can put the system into an Emergency state and acquire 3D data sets, but you cannot save them with any patient ID other than **EmergencyID**. See “Emergency State” on page 66.

1. 3D imaging on bk5000 is not licensed by Health Canada.

Controlling Transducer Movement

The 2D images in the data set are imaged with the transducer in different positions. The transducer can be moved in the following way:

- With a system-controlled positioning device (external or built into the transducer)
- Untracked freehand (see warning below).

System-Controlled Positioning

If the transducer is moved with a system-controlled positioning device, you can make measurements on the reconstructed 3D volume. There are various system-controlled positioning devices you can use:

- The built-in 3D mover in the 20R3 transducer
- The magnetic wheel mover for the E14C4t and E14CL4b transducers

The 20R3 Transducer

The 20R3 transducer has a built-in mover for 3D acquisition. For information about setting up and attaching this transducer, see the 20R3 transducer user guide.

The Magnetic Wheel Mover

The magnetic wheel mover (UA 0513) is designed for use with the E14C4t and E14CL4b transducers. The mover is a system-controlled positioner that rotates the transducer about its long axis to produce a fanned data set or pulls the transducer back to produce a set of parallel images. The magnetic wheel mover must be used with the connector adapter (UA 2356), which connects to a transducer socket.

For information about setting it up, using it and caring for it, including important safety warnings, see the magnetic wheel mover user guide.

Untracked Freehand Acquisition

Untracked linear and fan acquisitions (freely moving the transducer while you acquire a 3D data set) are allowed with any transducer. However, certain combinations of motion and transducer will not produce a sensible 3D volume.

Imaging Direction

You must select the imaging direction icon that corresponds to the direction you plan to move the transducer. See “Setting the Mover and Imaging Direction” on page 203. The icon you choose gives the system information about how to reconstruct the 3D volume. If there is a mismatch, the resulting volume can be mirrored.

After you acquire the image, you must check the reconstructed volume to make sure that it is a correct representation of the data.

Measurements Not Accurate

	<p>WARNING 3D-w2</p> <p>You cannot make accurate measurements on a 3D data set acquired using the untracked freehand method.</p>
---	---

If you start to make a measurement on a 3D data set acquired using the untracked freehand method, a warning appears in red on the monitor to remind you that the measurement will not be accurate.

3D Imaging Overview

The 3D imaging process has the following steps:

- Preparations – see page 202
- Adjust settings – see page 203
- Acquisition – see page 204
- Viewing – see page 204
- Working with the 3D image – see page 206
- Save, Capture and Close – see page 214

To acquire a 3D image:

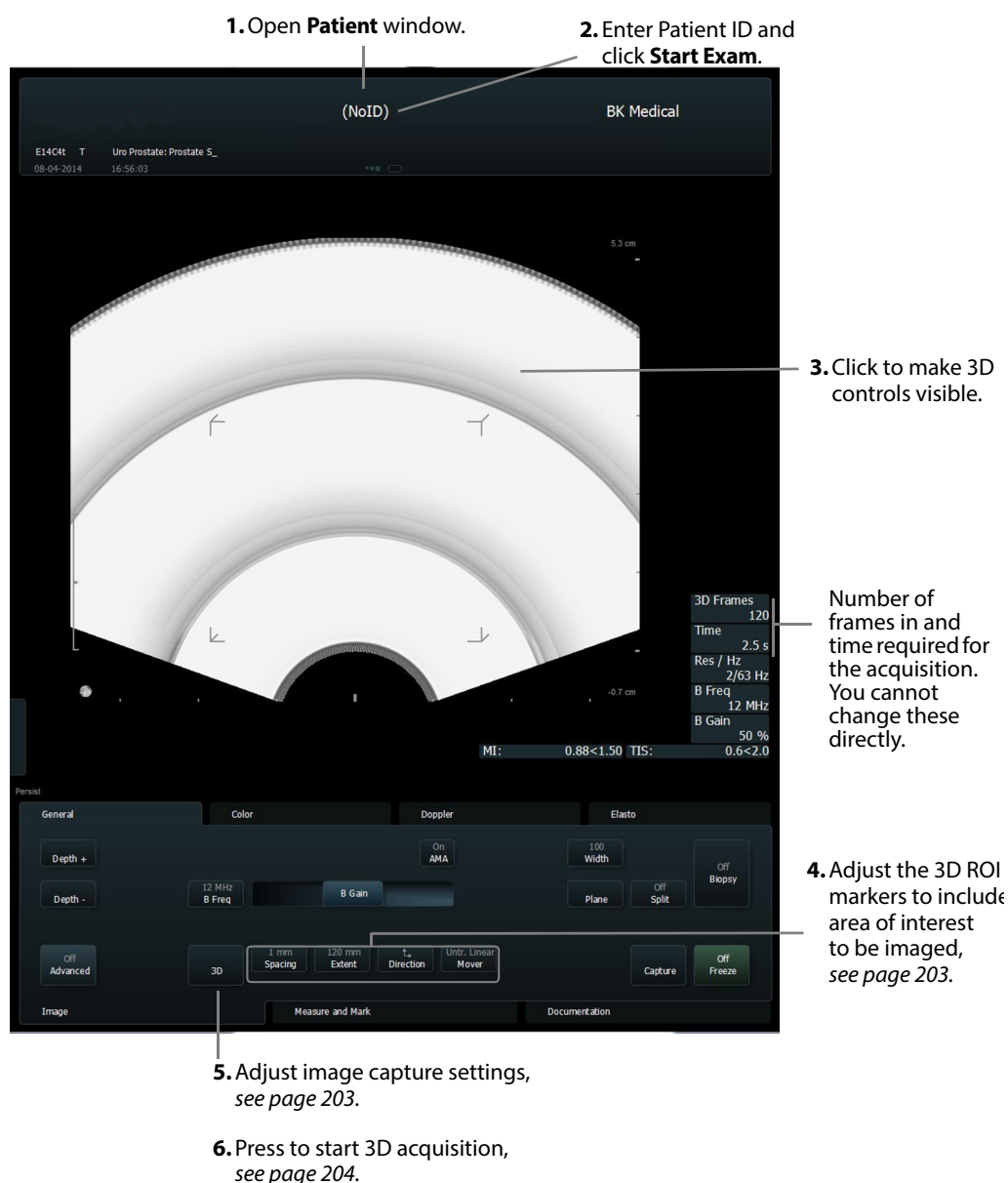

Figure 15-1. Basic overview of first steps.

Preparations

Before you start the 3D image acquisition:

- 1 Check all the connections. Connect the mover, if needed.
- 2 Choose the preset you want.
- 3 Optimize the 2D image.

NOTE: You cannot turn on 3D if the image is frozen.

NOTE: You cannot acquire 3D data sets unless you have entered a patient ID. If you have not entered a valid patient ID, you will be prompted to do so. The default patient ID is the current time and date.

Adjusting the Image Capture Settings

ROI (3D Region of Interest)

When you turn 3D on, 3D ROI markers (see Fig 15-1) appear in the image area to indicate the area that will be captured in the 3D data set.

NOTE: You cannot press the **Zoom** key to activate the 3D ROI box. The **Zoom** key continues to work in the normal way for the 2D image.

To move the 3D ROI box to a different part of the image, click inside the box to select it and drag it with the trackball. Click to release the cursor when the box is where you want it.

To resize the box (increase or decrease the area covered by the 3D acquisition), press +/- when the box is selected.

You can also resize the box by clicking one of the corners (selecting it) and then dragging the corner.

3D Capture Settings

You can set various 3D capture settings on the **Image** tab.

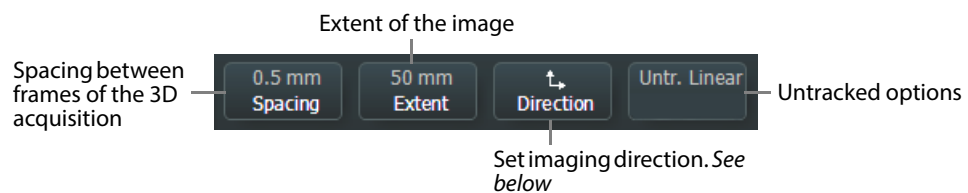

Figure 15-2. 3D image capture settings.

Setting the Mover and Imaging Direction

Movers with fixed direction

With certain movers, the imaging direction is fixed, and you cannot change it.

Select direction for other movers

For other movers, you set the direction that the mover will move by selecting the appropriate imaging direction icon.





Note: When you choose a mover, the system will change the 2D image orientation if a change is necessary to ensure that the 3D volume is reconstructed correctly. You are notified if this occurs.

Untracked freehand

Before you acquire an untracked freehand data set, it is essential to select the appropriate imaging direction icon so that the 3D volume will be reconstructed correctly. Be especially careful if you have changed the orientation (either up/down or left/right) of the 2D image (changed its orientation). In this case, the system will not make any automatic adjustments of orientation before 3D acquisition. The effect of a flipped 2D image on the resulting 3D volume can be confusing, so we recommend that you do *not* change the default orientation of the 2D image before acquiring a 3D data set.

You must select the imaging direction to match the direction that the transducer will move during acquisition.

NOTE: *If the patient is not lying on his or her back, be very careful when you choose the imaging direction because the directions are defined relative to a patient lying face-up.*

Direction	
	Clockwise (fanned)
	Counterclockwise (fanned)
	Inferior to Superior or Right to Left* (linear or pullback)
	Superior to Inferior or Left to Right* (linear or pullback)

* The directions are defined relative to a patient lying on his or her back.

Table 15-1. 3D imaging directions.

Acquisition

To start a 3D acquisition:

- Press the **3D** key.

or

- Click **3D**.

A progress bar appears during acquisition. The **3D** tab appears when you have acquired and/or are looking at the 3D cube.

NOTE: *During 3D acquisition, most keys and on-screen controls are disabled. You can use only the **Freeze** function (monitor or control panel), and the **3D** and **Cancel** keys.*

To stop a 3D acquisition before it is finished:

- Click **Stop** next to the progress bar.

or

- Press the **3D** or **Cancel** or **Freeze** key on the keyboard.

After you have acquired a 3D data set, it is displayed as a volume in the image area. You can select various ways of viewing the volume, and you can use various tools and settings to enhance the image.

Viewing a 3D Data Set

On the **3D General** tab, there are different **View** and **Preset** controls. These are described in detail later in this chapter:

Select between 6 different **Data Presentation Views**, see page 208

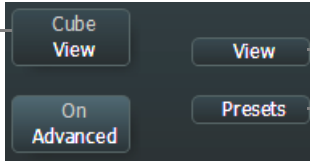

Select between **User Views** specific to individual volumes, see page 208

Select between **User Presets** for enhanced viewing of volumes, see below

NOTE: Imaging is frozen when any view of the 3D volume is displayed.

Enhancing a 3D View

When a 3D view is displayed, you can use various options on the **3D** tab to enhance the appearance of the 3D volume and make it easier to see the structures you are interested in:

- **Brightness**
- **Contrast**
- **Hue** – Click this to open a window where you can select a hue (color) to color the gray scale part of the volume.
- **Zoom**

Presets

After you have set **Brightness**, **Contrast**, **Hue**, and **Zoom**, and any Render settings, you can save your settings as a **Preset**; see Fig 15-3.

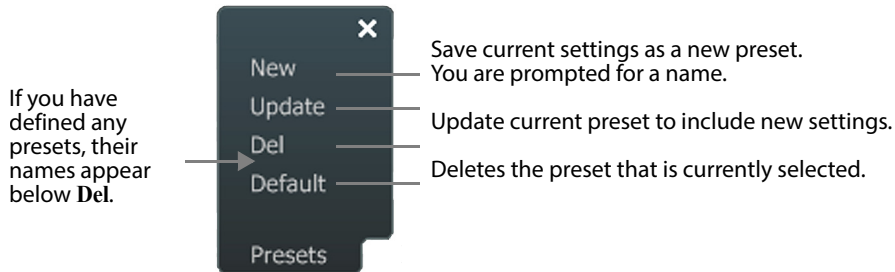

Figure 15-3. Options under Presets on the 3D tab.

3D Layout Options

When you view the acquired volume, you can change the layout of the monitor using the following options on the **3D Misc.** tab.

- **Orientation** – Turns the orientation marker on and off. The orientation marker is positioned on the first frame in the volume.
- **Wire Frame** – Shows or hides the wire frame on the volume.
- **Measure** (only in Cube view) – Shows or hides the measurement lines or boundaries on the volume, the **Measurement** menu (on the right side of the monitor), and **Measurement** results (on the left side of the monitor).

Working with the 3D Image

Manipulating the Volume

You can use the trackball and the **Select** key to manipulate the volume in various ways. The form of the cursor is different, depending on what you are doing.

Rotating



To rotate a volume in any direction:

- 1 Point outside the volume.
The cursor looks like this:
- 2 Hold the **Select** key down while you drag the cursor and rotate the volume.

You can also rotate the intersecting planes view in the 4-Up and 6-Up views.

Moving a Plane In and Out of the Volume

You can move a selected plane in and out of the volume to “slice” the volume so that a plane inside the original volume is displayed as a face of the transformed volume. This new face is called a “cut plane”. The cut plane can be parallel to a one of the original faces of the volume or at an angle (tilted) relative to the axes of the volume.



To slice the volume:

- 1 Move the cursor onto one of the volume faces.
The cursor looks like this:
- 2 Hold the **Select** key down while you drag the cursor to move the plane through the volume until the cut face you want is visible.
- 3 To restore parts of the volume that you have sliced away, drag the cut plane back through the volume.

Tilting a Plane

You can tilt a plane to see views that are not parallel to one of the original faces of the volume. (This often creates additional planes.)



To tilt a plane:

- 1 Click the edge of a plane to select it.
The cursor looks like this , and the wire frame around the plane becomes red.
- 2 Hold the **Select** key down while you drag the cursor to tilt the cut plane.
You can then move the tilted cut plane in and out (slice) as described before.

Moving the Volume

To move the volume:

- 1 Move the cursor so that it is inside the volume.
- 2 Hold down the **Shift** key and the **Select** key.
The cursor looks like a hand.

- 3 Drag the volume to the position you want, while holding the **Shift** key and the **Select** key down.
- 4 Click when the volume is where you want it.

Animating the Volume

To make the volume rotate automatically forward and back:

- On the **3D Misc.** tab, click **Play**.
The volume rotates.

To stop the rotation, click **Play** again.

On the **3D Misc.** tab you can click to adjust the following animation parameters (**Advanced** must be on):

- **Speed**
- **Span** – the extent of the rotation

Aligning, Splitting, or Deleting a Face

You can turn the volume so that a particular plane is facing you. You can also delete a cut plane or split a plane to create a tilted cut plane.

If you point at a plane of the volume and press the **+** side of the **+/-** key, a popup menu appears.

Click	Result
Delete Face	The plane disappears.
Align Face	The volume moves so that the plane is facing you.
Split Face	The selected face splits into two to create a tilted cut plane.

Annotating a 3D View

As with 2D images, you can annotate a 3D view with a label or arrow. You cannot use a bodymark.

You can add as many labels or arrows to a 3D view as you want. When you have finished, you can save the annotated image as a view that you name. You can save the image both as a 2D snapshot and as a 3D cube.

To add a label to a 3D view:

- 1 On the **3D General** tab, click **Label**.
A writing cursor appears.
- 2 Move the cursor to where you want the label.
- 3 Type the label.
- 4 Click. (You can drag the label to reposition it before you click; however, after you click, you cannot edit the label, only delete it.)
You can add additional labels.

- 5 When you have added all the labels you want, click **Label** again.
- 6 A window appears for you to name the view with the annotation. You can update the current view to include the annotation, or you can give it a new name.

To add an arrow to a 3D view:

- 1 On the **3D General** tab, click **Arrow**.
The cursor appears on the 3D volume with an arrow.
- 2 Press **+/-** to change the orientation of the arrow.
The tail of the arrow moves in a clockwise direction with each press.
- 3 Drag the arrow to where you want it and click.
An arrow is placed on the image.
- 4 You can add another arrow.
- 5 When you have added all the arrows you want, click **Arrow** again.
- 6 A window appears for you to name the view with the annotation. You can update the current view to include the annotation, or you can give it a new name.

NOTE: After you have positioned an annotation on the image and clicked, you cannot edit the annotation or move it. You can only delete it. To delete an annotation, click **Undo**. The most recent annotation is deleted. You can click **Undo** several times to remove more than one annotation. You can also click **Clear All** to remove them all.

User Views

After you enhance the 3D view and annotate it, you can save it as a User View. Settings for volume rotation and slicing, zoom level and annotations are saved in a User View. A User View is specific to a 3D volume.

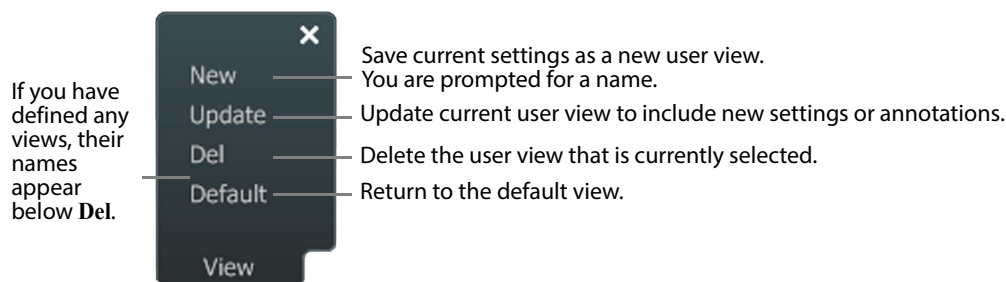
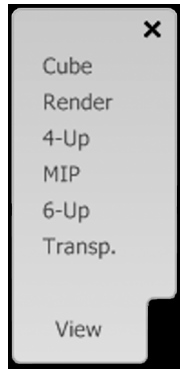

Figure 15-4. Options for User Views.

The 6 Data Presentation Views

There are 6 different ways you can view the 3D data set:



Cube – see below

Render – see page 211

4-Up – see page 213

MIP (Maximum Intensity Projection) – see page 213

6-Up – see page 214

Transparency – see page 213

Cube View

This is a texture-mapped representation of the volume. It is the default view.

Making Measurements in a Cube View

In a Cube view, you can measure the length, area and volume of a pathology, if you have used a system-controlled positioning device to acquire the data set. (You cannot make accurate measurements on data sets acquired using untracked freehand. See the warning on page 201.)

NOTE: *Making measurements on a 3D cube is not the same as making measurements on a 2D image, as described in Chapter 5, “Making Measurements”. After you have clicked to position a point to make a 3D measurement, you cannot move the point. You can only complete the measurement (if it requires more points) and then delete the measurement and make a new one.*

To make a 3D measurement:

- 1 Click the type of measurement you want on the **3D General** tab.
- 2 Click to position the points of the measurement. See Table 15-2.

When you click (or double-click, in the case of a polygon) the final point for the measurement, a number appears next to the lines you have drawn. The number is used to label the measurement results.

The results appear under the image.

Measurement	What to Do	Result
Distance	Click to position 2 points. A line connects them.	Distance between the points.
Angle	Click to position 3 points. Two intersecting lines appear.	Angle between the lines.
Area	Click points on the perimeter of the area. A polygon appears. The number of sides in the polygon increases with each click. When you have come to the last point, <i>double-click</i> to indicate that it is the final point in the polygon. You must click the points in order so that the polygon does not intersect itself – see note below.	Area of the polygon.
Volume	See instructions on page 210.	Volume calculated from polygons drawn on slices of the volume.

Table 15-2. Measurements on a 3D data set.

NOTE: You must click the points in order around the polygon perimeter. You cannot move a point once you have positioned it. If you backtrack, the polygon will intersect itself. If this happens, or if you have made another mistake in drawing the polygon, you must delete the entire measurement (click **Undo**) and start over. If you are in the middle of a volume measurement, the entire volume measurement is deleted, not just the current polygon.

Deleting Measurements

To delete a measurement:

- Click **Undo**.
The most recent measurement is deleted.

You can click **Undo** several times to remove more than one measurement.

To remove all measurements:

- Click **Clear All**.

Measuring Volumes

You measure a volume by drawing polygons around the area of interest on slices taken throughout the Cube. The method for drawing polygons is not the same as for 2D images.

To make a volume measurement on a 3D Cube:

- 1 Click **Volume** on the **3D General** tab.
- 2 Click **Step** and set the distance between slices of the cube that will be used for the volume measurements.

- 3 Draw a polygon around the area of interest by clicking points on the perimeter. When you have come to the last point, *double-click* to indicate that it is the final point in the polygon. See note above about clicking the points in order.
- 4 Click **Next** to move through the volume by the chosen step size or **Prev** to go to the previous step.
- 5 Outline the area of interest in the new slice.
- 6 Repeat steps 3, 4, and 5 for each slice until the area of interest is no longer visible (the volume measurement is completed).
The system updates the accumulated volume (in cm³) as each polygon is completed.
- 7 Click **Volume** again to finish the volume measurement.

NOTE: For information about accuracy of measurements on acquired and reconstructed planes, see the *bk3000 & bk5000 User Guide*.

	<p>WARNING 3D-w1</p> <p>Measurements obtained with the 3D system and used in diagnosis must be carefully and thoughtfully performed to ensure accurate quantitative assessment. Before you perform a calculation, make sure that all necessary calibrations and measurements are made.</p> <p>If you suspect that the 3D system's calibration is inaccurate (that is, the measurements are not as expected), contact your BK service representative to check and confirm the system's proper operation.</p>
---	--

NOTE: To undo the last measurement, click **Undo**.

Render View

Rendering dramatically improves 3D visualization. It is useful for looking in detail at soft tissues such as fistulas and abscess cavities. In this view, for gray scale volumes only, you can use sculpting tools to remove obstructing portions of the volume so you can better see the areas of interest.

Render Settings

You can change the way a Render view looks by adjusting the settings on the **3D misc.** tab (**Advanced** must be on):

- **Photo** – Adjusts the photorealistic parameter used in the rendering. This can only be used on gray scale volumes.
- **Opac** – Specifies the transparency (opacity) of a structure.
- **Thick** – Determines how far you can look into the volume.
- **Filter** – Sets a threshold so that pixels that are not as bright as the threshold are not displayed.

Sculpting Tools

Sculpting tools let you remove unwanted data from a Render view. Sculpting tools can only be used on gray scale volumes – when there is no color in the volume.

There are two sculpting tools:

- The cutting tool (which you can use to cut away the outside of the volume or to cut a hole inside the volume)
- The shaving tool

To use the sculpting tools:

1 Click **Sculpture** on the **3D misc.** tab to turn on the sculpting tools.

NOTE: If “Display” is Off (see “Displaying Sculpture Results” on page 212) the cursor does not change to a scalpel/shaver.

2 Click **Remove** to select **Inside**, **Outside** or **Shave**.

3 If you select **Inside**, you can adjust how deep you want to cut. Click **Depth** and move the slider to adjust the percentage that is removed when you move the cutting tool.

4 Use the different tools as described below.

5 To turn off the sculpting tools, click **Sculpture**.

To use the cutting tool (inside):

1 Click on one plane of the volume.

2 Hold down the **Select** key while you drag the  to draw a closed curve on the volume plane.

3 Release the **Select** key when you are finished.

If you have selected 100% **Depth**, a hole appears extending through the volume.

To use the cutting tool (outside):

1 Click on one plane of the volume.

2 Hold down the **Select** key while you drag the  to draw a closed curve on the volume plane.

3 Release the **Select** key when you are finished.

The area outside the curve disappears.

To use the shaving tool:

1 Click on one plane of the volume.

2 Hold down the **Select** key while you move the  cursor over the area to be shaved.

The longer you hold the **Select** key down, the more surface is removed.

3 Release the **Select** key when you are finished.

Displaying Sculpture Results

Click **Display** to toggle between a view showing the result of sculpting and the unsculpted view.

MIP View

Maximum Intensity Projection (MIP) emphasizes the pixels with the highest intensity in the volume. If the highest intensities are mapped to the highest blood flow velocities, this mode accentuates and reveals the peak velocity regions of a volume. It is useful for:

- Looking at maximum flow jets
- Visualizing skeletal structures beneath tissue
- Looking at vascularization

Transparency View

Transparency rendering (which is only possible when you have acquired the 3D volume using Color or Power mode) lets you adjust the relative transparencies of the color and the gray scale parts of the volume. This can allow hidden features to become visible.

Render Settings

You can change the way a Transparency view looks by adjusting the settings on the **3D Misc.** tab. In addition to the Render Settings available for a Render view, there are 2 Render Settings that apply only to a Transparency view:

- **Photo** – Adjusts the photorealistic parameter used in the rendering. This can only be used on gray scale volumes.
- **Opac** – Specifies the transparency (opacity) of a structure.
- **Thick** – Determines how far you can look into the volume.
- **Filter** – Sets a threshold so that pixels that are not as bright as the threshold are not displayed.

4-Up View

This view has three orthogonal plane views and a view showing the positions of these intersecting planes within the volume. The planes can be moved by adjusting them in the intersecting view.

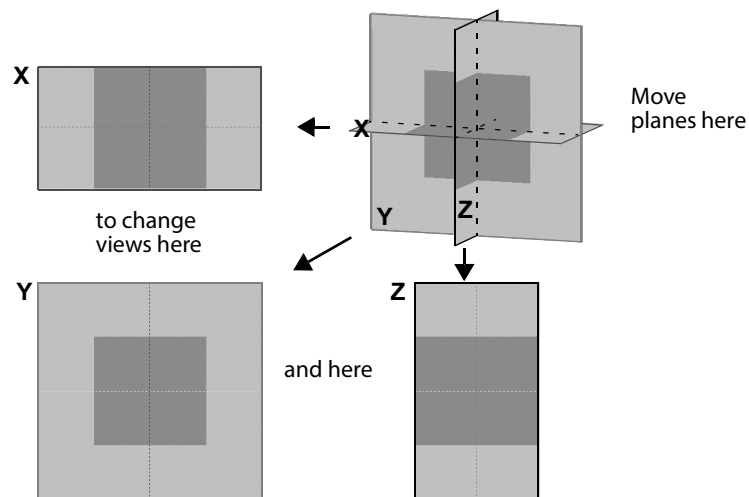

Figure 15-5. The 3D 4-Up View window.

6-Up View

In addition to the views in the 4-Up view, this view contains a Cube view and a sixth view, which is the view most recently displayed (MIP, Render, Transparency, or Cube).

Save, Capture and Close

After you view a 3D data set, there are 3 options:

- **Save** – Updates the 3D volume document in the patient archiving system to include saved User Views, measurements and the result of sculpting.
- **Capture** – Saves the 3D volume document to the system hard disk.
- **Close** – Closes the 3D viewer.

Chapter 16

DICOM

DICOM on the System

DICOM is not installed as a default on the system. When it is installed, it is set up specially to match your DICOM system and procedures.

NOTE: *Changing the DICOM setup can cause your system to not work properly. For example, you may be unable to print to a DICOM printer. All changes to the DICOM setup should be made by qualified service personnel only. Do not try to change the DICOM setup yourself.*

New Patient Information from a DICOM Worklist

The system may be set up so that you can retrieve a worklist of patients and then select a patient from the worklist.

Depending on how your DICOM system is set up, the worklist may appear as soon as you open the **Patient** window. If the worklist is blank, you can retrieve the information.

To retrieve a worklist:

- 1 Use the drop-down window in the upper right corner to select the dates you want the list to include.
- 2 Click **Update**.

The worklist appears in the window. If there are more patients than can fit in the window, you can scroll down to see the rest of the list.

To select a patient from the worklist:

- 1 Click the row that contains the patient.
Now that patient is shown in the fields next to the worklist.
- 2 If required, enter additional information in the fields in the window.

NOTE: *You cannot delete a document from the system that is in a queue to be sent to a DICOM device.*

Saving or Printing to a DICOM Network

Filenames of Documents Exported in DICOM Format

The filename of an exported document specifies the date and time the image was captured.

For example, 2D_20131022_135426_FV12345.dcm would be the label on an 2D image of patient FV12345 that was captured on October 22, 2013 at 1:54:26 P.M. (13:54:26).

Archiving to a PACS

If you have DICOM installed on your system, you can archive images and clips to a PACS.

To archive all documents for a patient or examination or individual documents:

- 1 Click to select the patient, the examination, or the individual documents you want to archive.
- 2 Click **Archive** on the **Documentation** tab, and select the **PACS system you want to archive to**.

Reports

It is possible to export DICOM Structured Reports.

Queue

When you archive to a (PACS), the information is copied and put into a queue to be transferred to the PACS. When the PACS is available, the information is transmitted.

NOTE: *If you have an accidental power failure while information is being transferred to the PACS, transfer may fail. Documents and information may not be stored in the PACS even though they appear to have been transferred successfully from the system.*

DICOM Status

A DICOM status indicator appears by the display values to the right of the image. It has a colored light next to it.

Status Indicator Color	Meaning
Green	No unsent documents. The LED disappears after 5 seconds.
Yellow	A document is being sent or waiting to be sent.
Red	A document was not sent successfully.

Table 16-1. DICOM status indicators.

If you click the DICOM status indicator, the **DICOM Status** window appears.

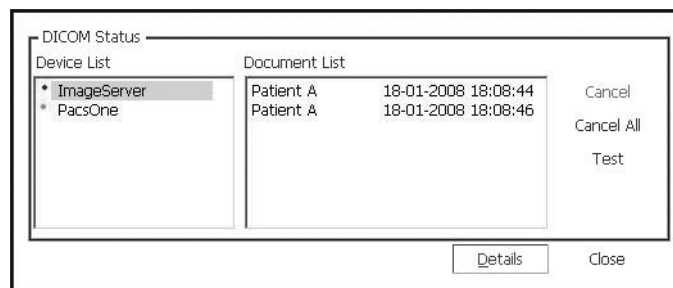

Figure 16-1. The DICOM status window.

The colors of the status indicator next to a device in the **Device List** are the same as described in Table 16-1. If a device has a red or yellow indicator, you can click the device name to see a list of unsent documents displayed in the **Document List**. To check the DICOM storage commitment status for the sent documents, you can search for patients with committed documents in the **Archive** window (see page 57).

You have the following options:

- **Cancel** – cancels the selected document.
- **Clear All** – clear all pending documents or jobs for the selected device.
- **Test** – tests the connection to the selected device (PING + C-ECHO).
- **Details** – see log of DICOM transactions - this is useful for a service technician.
- **Close** – closes the window and does nothing else.

To update the transaction log, click **Update**.

NOTE: *You can also open the **DICOM Status** window from the **DICOM Setup** window. See “**DICOM Setup**” on page 287.*

Deleting a Document

NOTE: *You cannot delete a document from the system that is in a queue to be sent to a DICOM device.*

Discontinuing an Examination with an MPPS Server

If an MPPS server is configured, you can discontinue the current examination. Click **More** and select **Discontinue Examination** to end the examination; the system will send a DISCONTINUE message back to the MPPS server. You will be prompted to confirm that the examination must be discontinued. Discontinuing the examination clears the current patient data and closes the **Patient** window.

Discontinued examinations can be retrieved from the Patient List for later completion; see Table 6-3, “Ways to select the patients displayed in the Examination List,” on page 63.

If you try to start or resume examinations on patients with discontinued examinations, you will be prompted to choose between these options:

- Continue the existing examination
- Delete existing examination and start a new
- Cancel

Appendix A

Glossary

This glossary contains explanations of terms and abbreviations that appear in the user guide or on the monitor. Measurements are listed in Appendix B, “Measurement Abbreviations”.

Term	Explanation
A/B	Stuart index. PS/ED.
ACI	ACI (Angular Compound Imaging) is a result of combining images made at up to 5 different angles into one compound image. This reduces speckle and optimizes the ultrasound image. NOTE: In certain cases ACI can remove or suppress some image artifacts such as shadowing (from e.g. kidney stones or cyst edges), which may be used to identify certain characteristics of the imaged anatomy.
AIUM	American Institute of Ultrasound in Medicine.
ALARA	As Low As Reasonably Achievable. Refers to the principle of keeping ultrasound exposure as low as possible (see the ALARA).
aliasing	Detection of a false flow in the opposite direction from the real flow. This can occur when the PRF used for the Doppler signal detection is not high enough compared to the flow speed. The problem only exists with pulsed wave Doppler detection.
Angular Compound Imaging	See ACI.
array transducer	A transducer that consists of a set of transducer elements, each capable of transmitting and receiving ultrasound.
Auto (Cardiac measurement)	PS, ED, RI, PS/ED
B/A	ED/PS
baseline	The baseline separates forward flow from reversed flow in Doppler imaging. Moving the axis can help overcome aliasing problems.
bodymark	A small drawing positioned on the image to help identify it in documentation.
catalog	A list of available items, as in a bodymark catalog or label catalog.
CFM	Color flow mapping. See Color mode.
cine	A function that lets you review a series of previously acquired images.
color box	When Color mode or Power mode imaging is turned on, the color box is superimposed on the B-mode image. The color box outlines the area of the tissue in which flow information is available.

Term	Explanation
color Doppler	See Color mode.
Color mode (CFM)	<p>Color-Flow Mapping (CFM). Real-time signal that represents the speed of flowing material in each sample volume within the Color mode image area. The Color mode signal is in principle independent of the amount of flowing material. The Color mode is normally superimposed on a B-mode image that shows the anatomical surroundings.</p> <p>Flow directions towards and away from the transducer are represented as different colors in Color mode (e.g. towards = red, away = blue).</p> <p>The Color mode signal (flow speed) is represented by different values in the color mapping (relative measure) for each sample volume in Color mode.</p> <p>No color means either:</p> <ul style="list-style-type: none"> • No flow in the sample volume (very low flow speed) or • Amount of reflection from flowing material (which might have a high flow speed) is below threshold set by the Color mode gain. <p>The Color mode signal (flow speed) is dependent on the angle of the ultrasound beam relative to the flow direction.</p>
color priority	<p>When color information is superimposed on a B-mode image, color can appear outside vessels, making it appear that the flow is not restricted to the vessel. To minimize this effect, you can adjust the color priority. Make the color priority lower to have less color outside the vessels. NOTE: High color priority gives color in more areas; low color priority reduces the number of areas that are colored.</p>
combination mode	Simultaneous imaging in more than one mode, for example, B+Color or B+Color+Doppler.
DecT	Flow Deceleration Time.
depth	<p>With a full B-mode image, you adjust the depth to cut out parts below the part you are interested in. The image always includes the transducer surface, so changing depth changes the magnification of the image, stretching, or compressing it. NOTE: To adjust the depth of the image without changing the magnification, use Panning. When the image is panned, the top of the image does not necessarily still correspond to the transducer surface. Adjusting the depth of a zoomed image changes the magnification even though the transducer surface is not necessarily visible at the top of the image.</p>

Term	Explanation
Doppler mode	(Spectral) Doppler mode. This mode displays information about the spectrum of flow velocities as a function of time. It is sometimes called FFT (Fast Fourier Transform) because the information is presented as a frequency spectrum indicating velocity components.
duplex	Simultaneous imaging in 2 modes. See combination mode.
dynamic range	The number of steps (gray scale change) between black and white.
EDC	Expected date of confinement.
EMC	Electromagnetic compatibility.
Enhanced Tissue Definition	See ETD.
ESD	Electrostatic discharge.
ETD	Enhanced Tissue Definition. With ETD, an automatic speckle suppression algorithm continuously analyzes the ultrasound image for irregularities and adjusts the smoothness to be applied. This reduces speckle and optimizes the ultrasound image. ETD supports all array transducers (mechanical transducers are not supported).
F1, F2	Frequency at position of marker 1 or 2 (when you make a measurement).
FFT	Fast Fourier Transform. FFT is a method of calculating the Fourier Transform (frequency spectrum) of something that is moving as a function of time. It is used to calculate the spectrum displayed in Doppler mode imaging.
FOI	Field of interest. The area within the B-mode image where resolution and focus are maximal.
freeze	Stop updating the image so an unchanging image is displayed. NOTE: When you freeze the image, the date and time displayed on the monitor are also frozen, so the time displayed on a printed image is the time when the image was frozen, not the time when it was printed.
gain	The overall amplification that is applied to ultrasound echoes from all depths.
HIPAA	Health Insurance Portability and Accountability Act of 1996. American law that sets rules for how patient accounts, billing and medical records must be handled.
IEC	International Electrotechnical Commission.
image review	See cine.
IOP	Intraoperative – during a surgical operation.
IVF	In vitro fertilization. NOTE: This system is not market cleared by the FDA for IVF use in the USA.

Term	Explanation
label	Text positioned on the image to label it. See page 31.
LC	Length of cycle.
line density	Line density is a measure of how closely spaced the image lines are in the ultrasound image. Increasing the line density decreases the frame rate so that you get finer resolution but a slower refresh rate (frame rate).
LMP	Last menstrual period. LMP is the abbreviation on reports. The field in the Patient window for this information is Last Menst. Date.
Long click	Pointing at an on-screen control and pressing the Select key for at least 1 second. See <i>Getting Started with bk3000 & bk5000</i> .
Long press	Pressing a key for 1 second or more. See <i>Getting Started with bk3000 & bk5000</i> .
MIP	Maximum Intensity Projection (3D imaging). See page 213.
MPG	Mean Pressure Gradient.
MPPS	Modality Performed Procedure Steps. If an MPPS server is configured, you can discontinue the current examination. See page 217.
MV All	Mitral valve all points.
NEMA	Association of Electrical and Medical Imaging Equipment Manufacturers (National Electrical Manufacturer's Association)
OB	Obstetrics.
PACS	Picture Archiving and Communications System (DICOM).
pan	Move the image so that different parts of the total scanned image are displayed on the screen.
PE	Previous examination.
PED	Previous examination date.
perioperative	Around the time of a surgical operation.
persistence	Persistence is the amount of time over which B-mode image frames are averaged on the monitor. High persistence increases the contrast in the image, but tissue movement will blur a high-persistence image.
PG	Pressure Gradient
phased array	A technique to control the image area by using time delays on an array transducer.
PI	Pulsatility index.

Term	Explanation
planimetry	Measuring the surface area and perimeter of an object by tracing its boundaries.
POI	Point of interest.
Power Doppler	See Power mode.
Power mode	Power mode (power Doppler) ultrasound displays information about the number of particles moving, rather than their velocity. The signal strength (related to the square of the velocity) increases as the number of flowing particles increases. Thus the amplitude of the signal indicates the amount of blood present and flowing within a sample volume.
power supply cord	The cord that connects the system to the wall outlet or power supply.
PRF	Pulse repetition frequency.
Pro Package	An application package containing presets, measuring tools and calculation formulas.
PSA	Prostate-specific antigen.
PSAD	PSA density: PSA divided by prostate volume.
pulse repetition frequency	The rate at which pulses of ultrasound waves are transmitted and received in PW (pulsed-wave) Doppler imaging.
PW Doppler	Pulsed wave Doppler. PW Doppler is the primary Doppler mode. In PW Doppler, short bursts (pulses) of ultrasound waves are transmitted at regular intervals and analyzed as they return. The received signals are detected and sent to amplifiers for audio output as well as displayed on the monitor for a visual presentation of the frequency components (spectrum).
Range (of velocities)	You can vary the PRF (pulse repetition frequency) to select the range of Doppler velocities (frequencies) that are color-coded and displayed. Restricting the range allows you to see velocity differences (within the range) in more detail.
Shots per estimate	One way to improve the accuracy of the color-coded velocity information is to increase the number of pulses transmitted in each waveform packet (shots per estimate) at the expense of decreasing the frame rate.
screen key	A control on the monitor that looks like a key or button.
spectral Doppler	See Doppler mode.
SS	Start systole.
steering	You can steer the Doppler beam of a linear transducer to vary the beam angle. This can be useful for examining flow in blood vessels parallel to the transducer surface.

Term	Explanation
stitch line	(Available only for 3D imaging.) Some transducers enabled for 3D imaging can be set to image 360°. At that setting, the start and end points for the image are referred to as the <i>stitch angle</i> or <i>stitch line</i> . More information is provided in the appropriate transducer user guide.
ON/standby button	The switch on the back of the system used for turning the system on and off each day.
TAM	Time Average Mean.
TAMX	Time Average Max.
T-area	Transverse Area.
TEH	True echo harmonics. BK Medical's trademarked term for its pulse inversion tissue harmonic imaging system.
TGC	Time gain control. The TGC curve determines variable amplification applied to echoes from different depths in the tissue. The TGC function compensates for attenuation and scattering of the ultrasound beam in the tissue.
TI	Thermal index. The estimated rise in tissue temperature (in °C) caused by the power emitted by the transducer.
TIB	Thermal index in bone at focal point.
TIC	Thermal index, cranial – bone at surface.
TIS	Thermal index in soft tissue.
triplex	Simultaneous imaging in 3 modes. See combination mode.
voxel	A three-dimensional pixel. A volume pixel .
wall filter	A wall filter is used to eliminate low-frequency artifacts (such as Doppler shifts arising from respiratory and cardiac motion or movement of blood vessel walls) in Color, Power and Doppler modes. The wall filter cuts off all frequencies below its cutoff frequency. You can adjust the cut-off frequency.
width	For some transducers, you can increase the width of the image area beyond normal full width. With linear transducer arrays, this is sometimes referred to as Trapezoidal View. You can also narrow the image width to increase frame rate.

Appendix B

Measurement Abbreviations

Measurement	Explanation
%ST Area	% Stenosis Area
%ST Dist	% Stenosis Distance
1 Angle	1 Angle
2 Angles	2 Angles
A/B	Stuart index. PS/ED. Systolic Velocity/Diastolic Velocity
AC	Abdominal Circumference
AC - ATD + APD	Abdominal Circumference - ATD + APD
AC - Campbell	Campbell Abdominal Circumference
AC Device	Abdominal Circumference Device
AC - Ellipse	Abdominal Circumference - Ellipse
AC - Freehand	Abdominal Circumference - Ellipse
AC - Hadlock	Hadlock Abdominal Circumference
AC - Jeanty	Jeanty Abdominal Circumference
Acc	Acceleration (velocity)
AccT	Flow Acceleration Time
AD	Abdominal Diameter
AD - Persson (AC)	Persson Abdominal Diameter - AC
AD - Persson (APD + ATD)	Persson Mean Abdominal Diameter
Ad	Adenoma (H, L, Vol or W)
AFI	Amniotic Fluid Index
All	Aortic Valve All (M-Mode)
Alpha1	Alpha1 Angle
Alpha2	Alpha2 Angle using 180°
Alpha3	Alpha3 Angle using 360°
ALSs	Aortic Valve Leaflet Separation, systole
Angle	Angle

Measurement	Explanation
Anorectal	Anorectal Angle
AO diameter d	Aortic Root Dimension, diastole
AO diameter s	Aortic Root Dimension, systole
AOd	Aortic Root Dimension, diastole
Aod Dia	Aorta Distal Vessel outside diameter
Aod PS	Aorta Distal Peak Systole
Aom Dia	Aorta Mid Vessel outside diameter
Aom PS	Aorta Mid Peak Systole
Aop Dia	Aorta Proximal Vessel outside diameter
Aop PS	Aorta Proximal Peak Systole
APD	Anteroposterior Diameter
AT	Acceleration Time
AT/ET	Acceleration Time/Ejection Time
ATD	Abdominal Transverse
Auto	Auto Doppler Calculations (PS, ED, RI, PS/ED)
Auto AV	Auto AV Cardiac Calculations
Auto MV	Auto MV Cardiac Calculations
Auto PV	Auto PV Cardiac Calculations
Auto TV	Auto TV Cardiac Calculations
AVA	Aortic Valve Area
Avg. ET	Average Endometrial Thickness
B/A	Diastolic Velocity/Systolic Velocity (ED/PS)
Beta1	Beta1 Angle
Beta2	Beta2 Angle using 180°
Beta3	Beta3 Angle using 360°
Bladder	Bladder Outline
Bl	Bladder (H, L, Vol or W)
BND	Bladder Neck Descent
BPD	Biparietal Diameter
BPD - Campbell	Campbell Biparietal Diameter

Measurement	Explanation
BPD - DSOG	DSOG Biparietal Diameter
BPD - DSOG (BPD,FL)	DSOG Biparietal Diameter (and Femur Length)
BPD - Eik-Nes	Eik-Nes Biparietal Diameter
BPD - Hadlock	Hadlock Biparietal Diameter
BPD - Hansmann	Hansmann Biparietal Diameter
BPD - Hobbins	Hobbins Biparietal Diameter
BPD - Jeanty	Jeanty Biparietal Diameter
BPD - Kurtz	Kurtz Biparietal Diameter
BPD - Persson	Persson Biparietal Diameter
BPD - Robinson	Robinson Biparietal Diameter
BPD - Tokyo	Tokyo Biparietal Diameter
BSA	Body Surface Area
BSA	Body Surface Area (m ²)
BSD	Bladder Neck Symphysis-Pubis Distance
BWT	Bladder Wall Thickness
CI	Cephalic Index
CI	Cardiac Index
CI (BPD + OFD)	Cephalic Index - BPD + OFD
CI (HC)	Cephalic Index - HC
Circle	General Circle
CO	Cardiac Output
CRL	Crown Rump Length
CRL - Campbell	Campbell Crown Rump Length
CRL - DSOG	DSOG Crown Rump Length
CRL - Hadlock	Hadlock Crown Rump Length
CRL - Hansmann	Hansmann Crown Rump Length
CRL - Hobbins	Hobbins Crown Rump Length
CRL - Jeanty	Jeanty Crown Rump Length
CRL - Persson	Persson Crown Rump Length
CRL - Robinson	Robinson Crown Rump Length

Measurement	Explanation
CRL - Tokyo	CRL - Tokyo
Cyst	Cyst diameter
DecT	Flow Deceleration Time
dF dV	Frequency Difference / Velocity Difference
Dist	Distance
DSOG (BPD,FL)	DSOG Biparietal Diameter and Femur Length
dT	Time Difference
dT	M Delta Time
ED	End Diastole
EDUA	End Diastole Uterine Artery
EdV	End-diastolic Volume
EF	Ejection Fraction
Ellipse	Ellipse (various organs)
Empiric	Empiric Volume
EsV	End-systolic Volume
ET	Endometrial Thickness
ET AV	Ejection Time Aortic Valve
ET MV	Ejection Time Mitral Valve
ET PV	Ejection Time Pulmonic Valve
ET TV	Ejection Time Tricuspid Valve
FBL	Fibula Length
FD 1	Follicle Diameter (1 distance)
FD 2	Follicle Diameter (2 distances)
FD 3	Follicle Diameter (3 distances)
FD 3 (1,2)	Follicle Diameter (3 distances, distance 1 and 2)
FD 3 (3)	Follicle Diameter (3 distances, distance 3)
FL	Femur Length
FL/AC	Femur Length / Abdominal Circumference
FL/BPD	Femur Length / Biparietal Diameter
FL - Campbell	Campbell Femur Length

Measurement	Explanation
FL - DSOG	DSOG Femur Length
FL - DSOG (BPD,FL)	DSOG Femur Length (and Biparietal Diameter)
FL - Hadlock	Hadlock Femur Length
FL - Hansmann	Hansmann Femur Length
FL - Persson	Persson Femur Length
FL - Tokyo	Tokyo Femur Length
Freehand	General Freehand
FS	Fractional Shortening
FV1	Frequency/Velocity 1
FV1/FV2	Frequency Ratio/Velocity Ratio
FV2	Frequency/Velocity 2
FW	Fetal Weight
FW(GA)	Fetal Weight from Clinical Gestational Age
FW - Campbell (AC)	Campbell Fetal Weight
FW - DSOG (BPD,AD)	DSOG (BPD,AD) Fetal Weight
FW - DSOG (BPD,AD,FL)	DSOG (BPD,AD,FL) Fetal Weight
FW - Eik-Nes (BPD,ATD)	Eik-Nes Fetal Weight
FW - Hadlock (AC,FL)	Hadlock (AC,FL) Fetal Weight
FW - Hansmann (BPD,TT)	Hansmann Fetal Weight
FW - Persson (BPD,AD)	Persson (BPD,AD) Fetal Weight
FW - Persson (BPD,AD,FL)	Persson (BPD,AD,FL) Fetal Weight
FW - Shepard (AC,BPD)	Shepard Fetal Weight
FW - Warsof (AC,BPD)	Warsof Fetal Weight
GA	Gestational age
Gamma1	Gamma1 Angle
Gamma2	Gamma2 Angle using 180°
Gamma3	Gamma3 Angle using 360°
Gleason Score	Gleason Score
GS	Gestational Sac
GS 1	Gestational Sac (1 distance)

Measurement	Explanation
GS 2	Gestational Sac (2 distances)
GS 3	Gestational Sac (3 distances)
GS 3 (1,2)	Gestational Sac (3 distances, distance 1 and 2)
GS 3 (3)	Gestational Sac (3 distances, distance 3)
GS Device	Gestational Device
GS - Hansmann	Hansmann Gestational Sac
GS - Hellman	Hellman Gestational Sac
GS - Tokyo	Tokyo Gestational Sac
H	Height
H*W*L	Volume H*W*L (various organs)
HC	Head Circumference
HC - BPD + OFD	Head Circumference - BPD + OFD
HC - Campbell	Campbell Head Circumference
HC - Circle	Head Circumference - Circle
HC Device	Head Circumference Device
HC - Ellipse	Head Circumference - Ellipse
HC - Freehand	Head Circumference - Freehand
HC - Hadlock	Hadlock Head Circumference
HC - Hansmann	Hansmann Head Circumference
HC - Polygon	Head Circumference - Polygon
HC/AC	Head Circumference / Abdominal Circumference Ratio
HR	Heart Rate
HR (1-10)	Heart rate where the number in parentheses is the number of cycles between the markers
IVC Dia	Inferior Vena Cava Vessel outside diameter
IVC VCT	Inferior Vena Cava Valve Closure Time
IVSd	Interventricular Septal Thickness, diastole
IVSs	Interventricular Septal Thickness, systole
Kd	Kidney (H, L, Vol or W)
L	Length
L Ellipse	Empiric Longitudinal Ellipse

Measurement	Explanation
L Empiric	Empiric Longitudinal
L Freehand	Empiric Longitudinal Freehand
L Thy-H	Left Thyroid Height
L Thy-L	Left Thyroid Length
L Thyroid Vol	Left Thyroid Vol. (Proc)
L Thy-V	Left Thyroid Volume
L Thy-W	Left Thyroid Width
LA diameter systole	Left Atrium Medial-Lateral Diameter, systole
LA/AO	LADs/AOd Ratio
LA/AO Ratio	LA Diameter, systole / AO Diameter, systole
LADs	Left Atrium Dimension, systole
LATV Dia	Left Anterior Tibial Vein Vessel outside diameter
LATV VCT	Left Anterior Tibial Vein Valve Closure Time
LBGAd Dia	Left Anterior Tibial Vein Vessel outside diameter
LBGAd PS	Left Anterior Tibial Vein Valve Peak Systole
LBGAp Dia	Left Bypass Graft Distal Anastomosis Vessel outside diameter
LBGAp PS	Left Bypass Graft Proximal Anastomosis Peak Systole
LBGi Dia	Left Bypass Graft Inflow Vessel outside diameter
LBGi PS	Left Bypass Graft Inflow Peak Systole
LBGO Dia	Left Bypass Graft Outflow Vessel outside diameter
LBGO PS	Left Bypass Graft Outflow Peak Systole
Lbulb ED	Left Bulb End Diastole
Lbulb PS	Left Bulb Peak Systole
LCCA	Left Common Carotid Artery
LCCA/RCCA	Left Common Carotid Artery / Right Common Carotid Artery Ratio
LCCAd ED	Left Common Carotid Artery Distal End Diastole
LCCAd PS	Left Common Carotid Artery Distal Peak Systole
LCCAm ED	Left Common Carotid Artery Mid End Diastole
LCCAm PS	Left Common Carotid Artery Mid Peak Systole
LCCAp ED	Left Common Carotid Artery Proximal End Diastole

Measurement	Explanation
LCCAp PS	Left Common Carotid Artery Proximal Peak Systole
LCFA Dia	Left Common Femoral Artery Vessel outside diameter
LCFA PS	Left Common Femoral Artery Peak Systole
LCFV Dia	Left Common Femoral Vein Vessel outside diameter
LCFV VCT	Left Common Femoral Vein Valve Closure Time
LCIA Dia	Left Common Iliac Artery Vessel outside diameter
LCIA PS	Left Common Iliac Artery Peak Systole
LCIV Dia	Left Common Iliac Vein Vessel outside diameter
LCIV VCT	Left Common Iliac Vein Valve Closure Time
LDPA Dia	Left Dorsalis Pedis Artery Vessel outside diameter
LDPA PS	Left Dorsalis Pedis Artery Peak Systole
LECA	Left External Carotid Artery
LECA ED	Left External Carotid Artery End Diastole
LECA PS	Left External Carotid Artery Peak Systole
LECA/LCCA	Left External Carotid Artery / Left Common Carotid Artery Ratio
LECA/RECA	Left External Carotid Artery / Right External Carotid Artery Ratio
LEIA Dia	Left External Iliac Artery Vessel outside diameter
LEIA PS	Left External Iliac Artery Peak Systole
LEIV Dia	Left External Iliac Vein Vessel outside diameter
LEIV VCT	Left External Iliac Vein Valve Closure Time
LICA	Left Internal Carotid Artery
LICA/LCCA	Left Internal Carotid Artery / Left Common Carotid Artery Ratio
LICA/RICA	Left Internal Carotid Artery / Right Internal Carotid Artery Ratio
LICAd ED	Left Internal Carotid Artery Distal End Diastole
LICAd PS	Left Internal Carotid Artery Distal Peak Systole
LICAm ED	Left Internal Carotid Artery Mid End Diastole
LICAm PS	Left Internal Carotid Artery Mid Peak Systole
LICAp ED	Left Internal Carotid Artery Proximal End Diastole
LICAp PS	Left Internal Carotid Artery Proximal Peak Systole
LFAAd Dia	Left Femoral Artery Distal Vessel outside diameter

Measurement	Explanation
LFA_d PS	Left Femoral Artery Distal Peak Systole
LFA_m Dia	Left Femoral Artery Mid Vessel outside diameter
LFA_m PS	Left Femoral Artery Mid Peak Systole
LFA_p Dia	Left Femoral Artery Proximal Vessel outside diameter
LFA_p PS	Left Femoral Artery Proximal Peak Systole
LFV_d Dia	Left Femoral Vein Distal Vessel outside diameter
LFV_d VCT	Left Femoral Vein Distal Valve Closure Time
LFV_m Dia	Left Femoral Vein Mid Vessel outside diameter
LFV_m VCT	Left Femoral Vein Mid Valve Closure Time
LFV_p Dia	Left Femoral Vein Proximal Vessel outside diameter
LFV_p VCT	Left Femoral Vein Proximal Valve Closure Time
LGN Dia	Left Gastrocnemius Vein Vessel outside diameter
LGN VCT	Left Gastrocnemius Vein Valve Closure Time
LGSV Dia	Left Great Saphenous Vein Vessel outside diameter
LGSV VCT	Left Great Saphenous Vein Valve Closure Time
LGSV-C Dia	Left Great Saphenous Vein of Calf Vessel outside diameter
LGSV-C VCT	Left Great Saphenous Vein of Calf Valve Closure Time
LGSV-T Dia	Left Great Saphenous Vein of Thigh Vessel outside diameter
LGSV-T VCT	Left Great Saphenous Vein of Thigh Valve Closure Time
L-Kd	Left Kidney (H, L, Vol or W)
LLS Dia	Left Lesser Saphenous Vein Vessel outside diameter
LLS VCT	Left Lesser Saphenous Vein Valve Closure Time
LOH	Left Ovary Height
LOL	Left Ovary Length
LO-Vol	Left Ovary Volume
LOW	Left Ovary Width
LPerf-B Dia	Left Boyd's Perforating Vein Vessel outside diameter
LPerf-B VCT	Left Boyd's Perforating Vein Valve Closure Time
LPerf-C Dia	Left Cockett's Perforating Vein Vessel outside diameter
LPerf-C VCT	Left Cockett's Perforating Vein Valve Closure Time

Measurement	Explanation
LPerf-H Dia	Left Hunterian Perforating Vein Vessel outside diameter
LPerf-H VCT	Left Hunterian Perforating Vein Valve Closure Time
LPFAp Dia	Left Profunda Femoris Artery Vessel outside diameter
LPFAp PS	Left Profunda Femoris Artery Peak Systole
LPFVp Dia	Left Profunda Femoris Vein Vessel outside diameter
LPFVp VCT	Left Profunda Femoris Vein Valve Closure Time
LPopA Dia	Left Popliteal Artery Vessel outside diameter
LPopA PS	Left Popliteal Artery Peak Systole
LPopV Dia	Left Popliteal Vein Vessel outside diameter
LPopV VCT	Left Popliteal Vein Valve Closure Time
LPrnIVd Dia	Left Peroneal Vein Distal Vessel outside diameter
LPrnIVd VCT	Left Peroneal Vein Distal Valve Closure Time
LPrnIVm Dia	Left Peroneal Vein Mid Vessel outside diameter
LPrnIVm VCT	Left Peroneal Vein Mid Valve Closure Time
LPrnIVp Dia	Left Peroneal Vein Proximal Vessel outside diameter
LPrnIVp VCT	Left Peroneal Vein Proximal Valve Closure Time
LPTAd Dia	Left Posterior Tibial Artery Distal Vessel outside diameter
LPTAd PS	Left Posterior Tibial Artery Distal Peak Systole
LPTAm Dia	Left Posterior Tibial Artery Mid Vessel outside diameter
LPTAm PS	Left Posterior Tibial Artery Mid Peak Systole
LPTAp Dia	Left Posterior Tibial Artery Proximal Vessel outside diameter
LPTAp PS	Left Posterior Tibial Artery Proximal Peak Systole
LPTVd Dia	Left Posterior Tibial Vein Distal Vessel outside diameter
LPTVd VCT	Left Posterior Tibial Vein Distal Valve Closure Time
LPTVm Dia	Left Posterior Tibial Vein Mid Vessel outside diameter
LPTVm VCT	Left Posterior Tibial Vein Mid Valve Closure Time
LPTVp Dia	Left Posterior Tibial Vein Proximal Vessel outside diameter
LPTVp VCT	Left Posterior Tibial Vein Proximal Valve Closure Time
LSClav ED	Left Subclavian Artery End Diastole
LSClavA PS	Left Subclavian Artery Peak Systole

Measurement	Explanation
LSFJ Dia	Left Saphenofemoral Junction Vessel outside diameter
LSFJ VCT	Left Saphenofemoral Junction Valve Closure Time
LSL Dia	Left Soleal Vein Vessel outside diameter
LSL VCT	Left Soleal Vein Valve Closure Time
L-Ts	Left Testis (H, L, Vol or W)
LV All	Measurements of Left Ventricle in systole and diastole plus calculations
LVAd - Ellipse	Left Ventricular Area, diastole - Bullet
LVAd - Freehand	Left Ventricular Area, diastole - Bullet
LVAs - Ellipse	Left Ventricular Area, systole - Bullet
LVAs - Freehand	Left Ventricular Area, systole - Bullet
LV Dia	Left Ventricle Diastole
LV Dists	Left Ventricle Dists
LV Parent	Left Ventricle Parent
LV Sys	Left Ventricle, systole.
LVAd	Left Ventricular Area, diastole
LVAs	Left Ventricular Area, systole
LVDd	Left Ventricular Internal Diameter, diastole
LVDs	Left Ventricular Internal Diameter, systole
LVertA ED	Left Vertebral Artery End Diastole
LVertA PS	Left Vertebral Artery Peak Systole
LVET	Left Ventricle Ejection Time
LVld	Left Ventricular Length, diastole
LVls	Left Ventricular Length, systole
LVM	Left Ventricle Cardiac Mass
LVOT diameter s	Left Ventricular Outflow Tract Diameter, systole
LVOT PFV	Left Ventricle Outflow Tract Peak Flow Velocity
LVPEP	Left Ventricle Pre-ejection Period
LVPWd	Left Ventricle Posterior Wall Thickness, diastole
LVPWs	Left Ventricle Posterior Wall Thickness, systole
MAD	Mean Abdominal Diameter

Measurement	Explanation
Manual AV	Manual Aortic Valve Cardiac Calculations
Manual MV	Manual Mitral Valve Doppler Calculations
Manual PV	Manual Pulmonic Valve Cardiac Calculations
Manual TV	Manual Tricuspid Valve Cardiac Calculations
MAPSE	Mitral Annular Plane Systolic Excursion
Mass	Mass
Mass	Mass Vol
MSS	Mitral Septal Separation
MVA	Mitral Valve Area
MV A	Mitral Valve A
MV A-C	Mitral Valve A-C Interval
MV All	Mitral Valve All points
MV C	Mitral Valve C
MV C-A	Mitral Valve C-A Separation
MV C-E	Mitral Valve C-E Separation
MV D	Mitral Valve D
MV D-E	Mitral Valve D-E Separation
MV D-E slope	Mitral Valve D-E slope
MVE	Mitral Valve E
MV E-F slope	Mitral Valve E-F slope
MV F	Mitral Valve F
MVA	Mitral Valve Area
Node	Lymph Node
NT	Nuchal Translucency (NT)
OFD	Occipito-Frontal Distance
Osaka	Osaka Fetal Weight from Clinical Gestational Age
Peak A	Atrial Contraction
Peak E	Early Diastolic Flow
PEP/ET	LV Pre-ejection period/LV Ejection time Ratio
Persson	Persson Fetal Weight from Clinical Gestational Age

Measurement	Explanation
PFV AV	Peak Flow Velocity Aortic Valve
PFV AV (Point)	Peak Flow Velocity Aortic Valve (Point)
PFV AV (Trace)	Peak Flow Velocity Aortic Valve (Trace)
PFV LA	Peak Flow Velocity, Left Atrium
PFV MV	Peak Flow Velocity, Mitral Valve
PFV MV (Point)	Peak Flow Velocity Mitral Valve (Point)
PFV MV (Trace)	Peak Flow Velocity Mitral Valve (Trace)
PFV MV / PFV LA	PFV MV / PFV LA Ratio
PFV PV	Peak Flow Velocity, Pulmonic Valve
PFV PV (Point)	Peak Flow Velocity Pulmonic Valve (Point)
PFV PV (Trace)	Peak Flow Velocity Pulmonic Valve (Trace)
PFV TV	Peak Flow Velocity, Tricuspid Valve
PFV TV (Point)	Peak Flow Velocity Tricuspid Valve (Point)
PFV TV (Trace)	Peak Flow Velocity Tricuspid Valve (Trace)
PHT MV	Pressure Half Time Mitral Valve
PI	Pulsatility Index (manual)
PIUA	Pulsatility Index Uterine Artery (manual)
PL	Foot Length
Planimetry	Volume of various organs
Planimetry (Ellipse)	Volume of various organs
Planimetry (Freehand)	Volume of various organs
Polygon	General Polygon
Pr	Prostate (H, L, Vol or W)
Prostate	Prostate Outline
PS	Peak Systole
PS/ED	Peak Systolic End Diastolic Ratio
PSA	Prostate-Specific Antigen
PSAD	PSA density: PSA divided by prostate volume
PSUA	Peak Systole Uterine Artery
RATV Dia	Right Anterior Tibial Vein Vessel outside diameter

Measurement	Explanation
RATV VCT	Right Anterior Tibial Vein Valve Closure Time
RBGAd Dia	Right Bypass Graft Distal Anastomosis Vessel outside diameter
RBGAd PS	Right Bypass Graft Distal Anastomosis Peak systole
RBGAp Dia	Right Bypass Graft Proximal Anastomosis Vessel outside diameter
RBGAp PS	Right Bypass Graft Proximal Anastomosis Peak systole
RBGI Dia	Right Bypass Graft Inflow Vessel outside diameter
RBGI PS	Right Bypass Graft Inflow Peak Systole
RBGO Dia	Right Bypass Graft Outflow Vessel outside diameter
RBGO PS	Right Bypass Graft Outflow Peak Systole
Rbulb ED	Right Bulb End Diastole
Rbulb PS	Right Bulb Peak Systole
RCCA	Right Common Carotid Artery
RCCA/LCCA	Right Common Carotid Artery / Left Common Carotid Artery Ratio
RCCAd ED	Right Common Carotid Artery Distal End Diastole
RCCAd PS	Right Common Carotid Artery Distal Peak Systole
RCCAm ED	Right Common Carotid Artery Mid End Diastole
RCCAm PS	Right Common Carotid Artery Mid Peak Systole
RCCAp ED	Right Common Carotid Artery Proximal End Diastole
RCCAp PS	Right Common Carotid Artery Proximal Peak Systole
RCFA Dia	Right Common Femoral Artery Vessel outside diameter
RCFA PS	Right Common Femoral Artery Peak Systole
RCFV Dia	Right Common Femoral Vein Vessel outside diameter
RCFV VCT	Right Common Femoral Vein Valve Closure Time
RCIA Dia	Right Common Iliac Artery Vessel outside diameter
RCIA PS	Right Common Iliac Artery Peak Systole
RCIV Dia	Right Common Iliac Vein Vessel outside diameter
RCIV VCT	Right Common Iliac Vein Valve Closure Time
RDPA Dia	Right Dorsalis Pedis Artery Vessel outside diameter
RDPA PS	Right Dorsalis Pedis Artery Peak Systole
Real-Time	Real-Time

Measurement	Explanation
RECA	Right External Carotid Artery
RECA ED	Right External Carotid Artery End Diastole
RECA PS	Right External Carotid Artery Peak Systole
RECA/LECA	Right External Carotid Artery / Left External Carotid Artery Ratio
RECA/RCCA	Right External Carotid Artery / Right Common Carotid Artery Ratio
Rectum	Rectum Outline
REIA Dia	Right External Iliac Artery Vessel outside diameter
REIA PS	Right External Iliac Artery Peak Systole
REIV Dia	Right External Iliac Vein Vessel outside diameter
REIV VCT	Right External Iliac Vein Valve Closure Time
RFA_d Dia	Right Femoral Artery Distal Vessel outside diameter
RFA_d PS	Right Femoral Artery Distal Peak Systole
RFA_m Dia	Right Femoral Artery Mid Vessel outside diameter
RFA_m PS	Right Femoral Artery Mid Peak Systole
RFA_p Dia	Right Femoral Artery Proximal Vessel outside diameter
RFA_p PS	Right Femoral Artery Proximal Peak Systole
RFV_d Dia	Right Femoral Vein Distal Vessel outside diameter
RFV_d VCT	Right Femoral Vein Distal Valve Closure Time
RFV_m Dia	Right Femoral Vein Mid Vessel outside diameter
RFV_m VCT	Right Femoral Vein Mid Valve Closure Time
RFV_p Dia	Right Femoral Vein Proximal Vessel outside diameter
RFV_p VCT	Right Femoral Vein Proximal Valve Closure Time
RGN Dia	Right Gastrocnemius Vein Vessel outside diameter
RGN VCT	Right Gastrocnemius Vein Valve Closure Time
RGSV Dia	Right Great Saphenous Vein Vessel outside diameter
RGSV VCT	Right Great Saphenous Vein Valve Closure Time
RGSV-C Dia	Right Great Saphenous Vein of Calf Vessel outside diameter
RGSV-C VCT	Right Great Saphenous Vein of Calf Valve Closure Time
RGSV-T Dia	Right Great Saphenous Vein of Thigh Vessel outside diameter
RGSV-T VCT	Right Great Saphenous Vein of Thigh Valve Closure Time

Measurement	Explanation
RI	Resistance Index
RICA	Right Internal Carotid Artery
RICA/LICA	Right Internal Carotid Artery / Left Internal Carotid Artery Ratio
RICA/RCCA	Right Internal Carotid Artery / Right Common Carotid Artery Ratio
RICAd ED	Right Internal Carotid Artery Distal End Diastole
RICAd PS	Right Internal Carotid Artery Distal Peak Systole
RICAm ED	Right Internal Carotid Artery Mid End Diastole
RICAm PS	Right Internal Carotid Artery Mid Peak Systole
RICAp ED	Right Internal Carotid Artery Proximal End Diastole
RICAp PS	Right Internal Carotid Artery Proximal Peak Systole
RIUA	Resistive Index Uterine Artery
R-Kd	Right Kidney (H, L, Vol, W)
RLS Dia	Right Lesser Saphenous Vein Vessel outside diameter
RLS VCT	Right Lesser Saphenous Vein Valve Closure Time
ROH	Right Ovary Height
ROL	Right Ovary Length
RO-Vol	Right Ovary Volume
ROW	Right Ovary Width
RPerf-B Dia	Right Boyd's Perforating Vein Vessel outside diameter
RPerf-B VCT	Right Boyd's Perforating Vein Valve Closure Time
RPerf-C Dia	Right Cockett's Perforating Vein Vessel outside diameter
RPerf-C VCT	Right Cockett's Perforating Vein Valve Closure Time
RPerf-H Dia	Right Hunterian Perforating Vein Vessel outside diameter
RPerf-H VCT	Right Hunterian Perforating Vein Valve Closure Time
RPFAP Dia	Right Profunda Femoris Artery Vessel outside diameter
RPFAP PS	Right Profunda Femoris Artery Peak Systole
RPFVp Dia	Right Profunda Femoris Vein Vessel outside diameter
RPFVp VCT	Right Profunda Femoris Vein Valve Closure Time
RPopA Dia	Right Popliteal Artery Vessel outside diameter
RPopA PS	Right Popliteal Artery Peak Systole

Measurement	Explanation
RPopV Dia	Right Popliteal Vein Vessel outside diameter
RPopV VCT	Right Popliteal Vein Valve Closure Time
RPrnIVd Dia	Right Peroneal Vein Distal Vessel outside diameter
RPrnIVd VCT	Right Peroneal Vein Distal Valve Closure Time
RPrnIVm Dia	Right Peroneal Vein Mid Vessel outside diameter
RPrnIVm VCT	Right Peroneal Vein Mid Valve Closure Time
RPrnIVp Dia	Right Peroneal Vein Proximal Vessel outside diameter
RPrnIVp VCT	Right Peroneal Vein Proximal Valve Closure Time
RPTAd Dia	Right Posterior Tibial Artery Distal Vessel outside diameter
RPTAd PS	Right Posterior Tibial Artery Distal Peak Systole
RPTAm Dia	Right Posterior Tibial Artery Mid Vessel outside diameter
RPTAm PS	Right Posterior Tibial Artery Mid Peak Systole
RPTAp Dia	Right Posterior Tibial Artery Proximal Vessel outside diameter
RPTAp PS	Right Posterior Tibial Artery Proximal Peak Systole
RPTVd Dia	Right Posterior Tibial Vein Distal Vessel outside diameter
RPTVd VCT	Right Posterior Tibial Vein Distal Valve Closure Time
RPTVm Dia	Right Posterior Tibial Vein Mid Vessel outside diameter
RPTVm VCT	Right Posterior Tibial Vein Mid Valve Closure Time
RPTVp Dia	Right Posterior Tibial Vein Proximal Vessel outside diameter
RPTVp VCT	Right Posterior Tibial Vein Proximal Valve Closure Time
RSclavA ED	Right Subclavian Artery End Diastole
RSclavA PS	Right Subclavian Artery Peak Systole
RSFJ Dia	Right Saphenofemoral Junction Vessel outside diameter
RSFJ VCT	Right Saphenofemoral Junction Valve Closure Time
RSL Dia	Right Soleal Vein Vessel outside diameter
RSL VCT	Right Soleal Vein Valve Closure Time
R Thy-H	Right Thyroid Height
R Thy-L	Right Thyroid Length
R Thyroid Vol.	Right Thyroid Vol. (Proc)
R Thy-V	Right Thyroid Volume

Measurement	Explanation
R Thy-W	Right Thyroid Width
R-Ts	Right Testis (H, L, Vol or W)
RVDd	Right Ventricle Internal Diameter, diastole
RVDs	Right Ventricle Internal Diameter, systole
RVertA ED	Right Vertebral Artery End Diastole
RVertA PS	Right Vertebral Artery Peak Systole
RVOT diameter d	Right Ventricular Outflow Tract Diameter, diastole
RVOT diameter s	Right Ventricular Outflow Tract Diameter, systole
Seminal Vesicles	Seminal Vesicles Outline
SI	Stroke Volume Index
ST Area 1	Stenosis Area 1. Area of vessel lumen before the stenosis. Used to calculate % stenosis.
ST Area 2	Stenosis Area 2. Area of residual lumen of vessel used to calculate stenosis. When you measure this after measuring ST Area 1, % stenosis is calculated.
ST Dist 1	Stenosis Distance 1. Transverse diameter (distance) of the vessel lumen before the stenosis.
ST Dist 2	Stenosis Distance 2. Transverse diameter (distance) of the lumen at the stenotic part of the vessel. When you measure this after measuring ST Dist 1, % stenosis is calculated.
ST Ellipse 1	Stenosis Ellipse 1
ST Ellipse 2	Stenosis Ellipse 2
ST Free 1	Stenosis Freehand 1
ST Free 2	Stenosis Freehand 2
SV	Stroke Volume
SV (M-Mode)	Stroke Volume
T Ellipse	Empiric Transversal Ellipse
T Empiric	Empiric Transversal
T Freehand	Empiric Transversal Freehand
TAM	Time Average Mean Velocity by Manual Trace
TAPSE	Tricuspid Annular Plane Systolic Excursion
TBL	Tibia Length
THAP	Thorax Anteroposterior Distance

Measurement	Explanation
Ts	Testis (H, L, Vol or W)
TT	Thorax Transverse Distance
Urethra	Urethra Outline
Uterine	Uterus (H, L, Vol or W)
VF	Volume Flow
VF (auto)	Volume Flow Based on Auto TAM
VF Area	Volume Flow Area
VF Circle	Volume Flow Circle
VF Dist	Volume Flow Distance
VF Ellipse	Volume Flow Ellipse
VL	Vertebra Length
VTI AV	Velocity Time Integral Aortic Valve
VTI LVOT	Velocity Time Integral Left Ventricle Outflow Tract
VTI MV	Velocity Time Integral, Mitral Valve
VTI PV	Velocity Time Integral, Pulmonic Valve
W	Width
Williams	Williams Fetal Weight from Clinical Gestational Age

Appendix C

Setting Up and Customizing Your System

The bk3000 and bk5000 include default setups that were created to optimize the ultrasound images and make it easy for you to use the different transducers, Pro Packages, and presets. You can customize the system so that it is easy to enter and select exactly the information you need, and so that the default setups fit your needs.

To access the setup and customization windows:

- 1 Go to the **Image** tab and click **Advanced**.
- 2 Click **Customize**. The **Customize** button is only available when **Advanced** is on.

All descriptions in this chapter assume you already have the customization window displayed on the monitor.

The window for customization of your system opens. In this window, you can customize the following details for your system:

- Pro Packages, page 246
- Monitor layout, page 247
- Keys and menus, page 247
- General system settings, page 250
- Measurements, page 264
- Labels and other markings, page 274
- License, page 282
- Exporting and importing data, page 282
- DICOM setup (if licensed), page 287

Pro Package and Presets

To open the setup window for Pro Packages and presets:

Click the **Pro/Setup** tab. (This is the default start page when you open the customization window.)

	E10C4 9019	18L5 9070	6C2 9040	E14CL4b 9023
Abdomen	-	-	<input checked="" type="checkbox"/> Abd-Gen_N <input type="checkbox"/> Abd-Pen_N <input type="checkbox"/> Abd-Res-N <input type="checkbox"/> Aorta_N <input type="checkbox"/> Bladder <input type="checkbox"/> Kidney_N <input type="checkbox"/> SonoVue <small>chr</small>	-
Brachy	-	-	-	<input checked="" type="checkbox"/>
Breast	-	<input checked="" type="checkbox"/> Breast	-	-
Cardiac	-	-	-	-
Carotid	-	<input checked="" type="checkbox"/> Carotid_N	-	-
Colorectal	-	-	-	-

The checkmark symbol indicates the default preset for each transducer in the Pro Package

The blue background indicates the default Pro Package for each transducer

Figure C-1. The Pro Package Setup Window.

In the **Pro Package Setup** window, the columns list the transducers (with connected transducers listed first) and the rows list the Pro Packages. The cells contain lists of the presets available for a particular transducer in a particular Pro Package. Use the scroll bars to see all the cells in the table.

In this window, you can:

- Specify which Pro Package is the default for each transducer (see Fig C-1).
- Specify which preset is the default for each transducer (see Fig C-1. This can be different for each Pro Package).
- Set a transducer head as default (for transducers with more than one head).
- Rename or delete a preset.

NOTE: You cannot rename a factory-defined preset.

- Copy a preset.
- Restore factory default presets. If you click this, a table appears where you can select the setups to restore.
- Save the active preset with a different name.

Doppler and M-Mode Monitor Layout

When you image in Doppler or M-mode, a B-mode image is also present on the monitor.

- The split between the modes can be vertical or horizontal.
- The size of the Doppler or M-mode image can be small, medium or large.
NOTE: *If you have the VariSeed or Live Image Transfer licenses activated, the image size is locked by default for the Brachy Pro Package. See Fig C-2.*

To open the Screen Layout Setup window:

- Click the **Split/Size** tab.

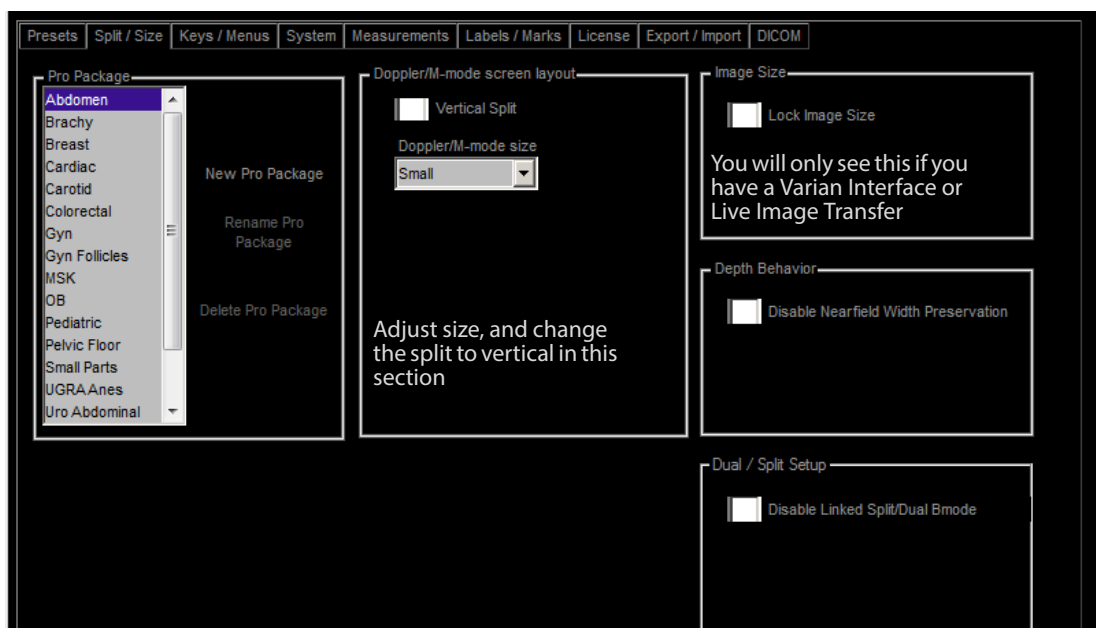

Figure C-2. The Screen Layout Setup window.

Depth Behavior

The system is set to preserve nearfield width when you decrease the depth of the image. You can change this here. If you check this, the tissue at the side of the image will not be visible when the depth is decreased.

User-Defined Keys

Customizing keys is one way to make the system fit your workflow preferences. You can assign functions to:

- The user-definable keys on the system keyboard.
- The foot-switch pedals.
- The “long press” or “short press” of the transducer buttons.

You can also change the setup so that a short press on transducer button 1 causes no action at all (like Freeze) to take place. To do this, select <Disabled>. (Pressing the button will still activate an inactive transducer, however.)

The same key can have different functions in different Pro Packages.

Here are the functions that you can assign to a user-definable key:

- 3D Activate
- ACI (Angular Compound Imaging)
- Angle Correction
- Auto Adjustment
- Autofocus
- BCD Toggle
- Biopsy
- B-Mode
- Cancel
- Capture
- Capture Clip
- Capture Image
- Cine
- Clear and Start Clip Buffer
- Clear Clip Buffer
- Color
- Color Off
- Depth -
- Depth +
- Doppler
- Doppler/M-Mode Screen Size
- Doppler/M-Mode Vertical/Horizontal Split
- Extended Resolution
- Freeze
- Harmonic
- Insert Arrow
- Insert Bodymark
- Invert
- Left/Right
- Line Density (B) -
- Line Density (C / P) -
- Line Density (C / P) +
- Measure/Timer
- Measurement [Various Organs]
- Measurement 3D [Volume Next]
- M-Mode
- Multibeam -
- Multibeam +
- Next crystal or head
- OEM Function Key
- OEM Synchronization
- Persist (B) -
- Persist (B) +
- Persist (C / P) -
- Persist (C / P) +
- Post Gain
- Power
- Print (DICOM)
- Print (PCL5)
- Print (PCL6)
- Print (PS)
- Print (USB B/W)
- Print (USB Color)
- Print Trigger 1
- Print Trigger 2
- Rotate -
- Rotate +
- Select Label
- Shots Per Est. -
- Shots Per Est. +
- Simultan
- Split
- Steering
- Store Image on PACS
- Toggle 3D View
- Toggle Scanning Plane
- Toggle Trace Curve
- Up/Down
- Update
- Wall Filter -
- Wall Filter +
- Zoom
- Zoom/Pan Reset

To open the Key Assignment Setup window:

- Click the **Keys/Menus** tab.

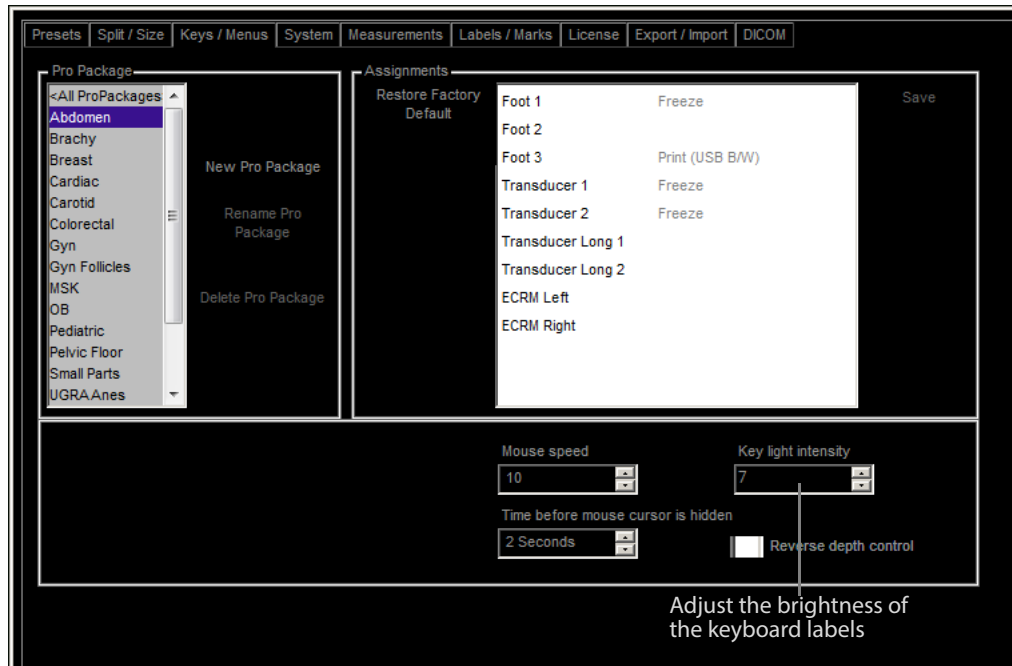

Figure C-3. The Key Assignment Setup window.

Assigning User-Defined Keys

To assign functions to the user-defined keys and foot-switch pedals:

- 1 Click the name of the Pro Package whose key assignments you want to modify. If you click <All Pro Packages>, the key assignments will apply to all Pro Packages.
- 2 On the right side, click the name of the key you want to define.
- 3 Click the ▼ that appears to the right for a drop-down menu of the possible functions for key assignments.
- 4 Click a function to assign it to the key.
- 5 Repeat 2 through 4 until you have defined as many keys as you want.
- 6 Click **Save**.

Customizing Key Brightness, Mouse Controls and Depth Control

In this window, you can also:

- Change the brightness of the key labels on the keyboard.
- Set the mouse (cursor) speed.
- Set the mouse cursor to be hidden after a specified period of inactivity.
- Set the way the depth control works.

Depth Control

By default, the depth control is set so that if you turn the **Depth/Zoom** control dial clockwise or click **Depth** on the monitor and press +, the depth is increased. (This means that the magnification of the ultrasound image get smaller.) You can reverse this setting if you want to use the depth controls as magnification controls.

To use the Depth control as a magnification control:

- Check **Reverse Depth Control**.

To use the Depth control as a depth control:

- Make sure that **Reverse Depth Control** is unchecked.

System Setup

Under the **System** tab, you will find:

- General Setup, page 250.
- Clip Storage Setup, page 252.
- 3D Setup, page 255.
- Printer Setup, page 255.
- Password Setup, page 257.
- Network Drive Setup, page 258.
- Version Information, page 258.
- Video I/O, page 260.
- Miscellaneous, page 262.

This section describes what you can configure and customize in each of these areas.

General Setup

In the **General Setup** window, you can change location information, language, video output format, date and time, and set the size of the staging area for burning CD/DVDs.

NOTE: *You can reset the system to the factory default setup in this window.*

To open the General Setup window:

- Click the **System** tab, and then, in the new window that appears, the **General** tab.

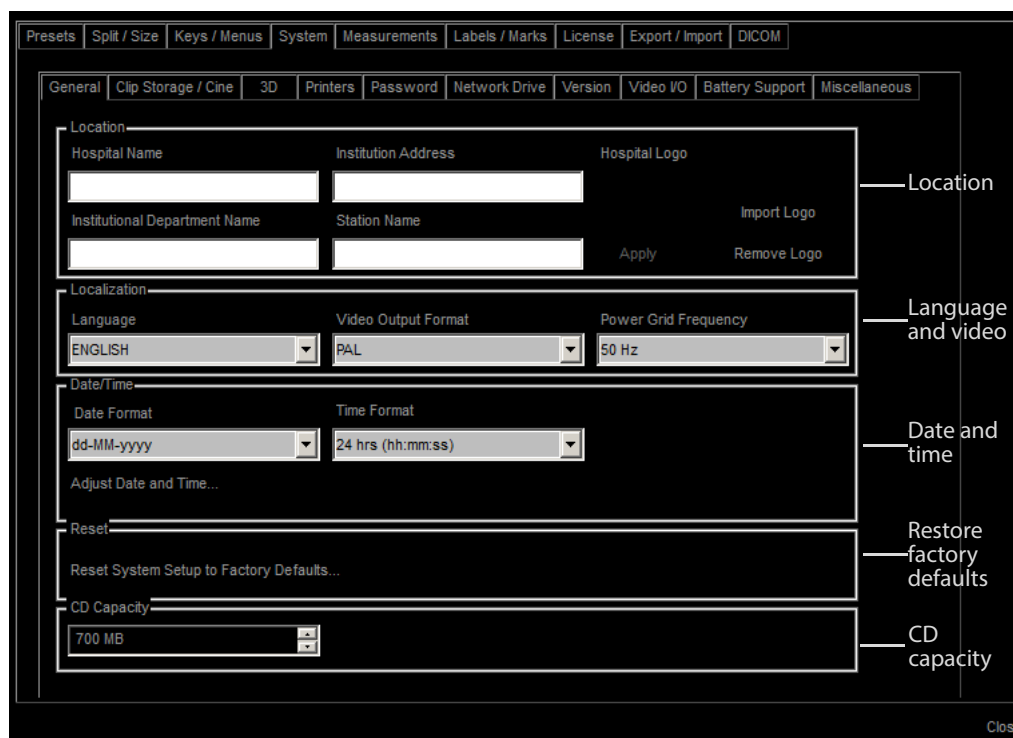

Figure C-4. The General Setup window.

Location Information

Institution information is displayed above the patient name at the top of the monitor and included in documents archived to a DICOM system. It appears in all documentation of the image. Because of space limitations, very long hospital names will be reduced in size or even truncated on the monitor. Consider using a shortened version of your hospital name instead.

Hospital Logo

You can include a hospital logo as part of the location information. To import a hospital logo, click **Import Logo**. A window opens in which you can select the logo file from a USB device that is attached to the system. The file must be in .bmp format with a maximum size of 171 x 19 pixels; larger file sizes will be resized to fit. The color black in RGB appears transparent and will not be visible.

Language

Warnings on the monitor can be displayed in different languages. Set the preferred language in the **General Setup** window (see Fig C-4).

NOTE: *Language changes will not take effect until you restart the system.*

Video Format

You can select PAL or NTSC for video output. For more information about video settings, see “Video I/O Setup” on page 260.

Date/Time

You can change the date and time in the usual Microsoft Windows **Date/Time Properties Setup** window. You cannot change existing time stamps.

To change the date or time:

- Click **Date/Time** in the **General Setup** window (Fig C-4).

A message appears, stating that existing time stamps cannot be changed. When you accept the statement, the **Date/Time Properties** window appears.

To change the date or time format:

- Select the date or time format in the **General Setup** window.

Restoring the Factory Setup

To restore all factory default settings on the system, click **Reset System Setup to Factory Defaults...** See Fig C-4.

NOTE: *If you restore the factory default settings, you will lose all customizations that have been made to the system.*

Setting the CD/DVD Size

You specify the size (storage capacity) of the CD or DVD that you will use for copying or archiving documents.

The size options are

- 185 MB
- 2.60 GB
- 5.20 GB
- 650 MB
- 3.97 GB
- 8.54 GB
- 700 MB
- 4.70 GB
- 9.40 GB

If the size of your disc is not listed, choose the largest value that is less than the actual size of your disc. Do not select a size larger than your disc.

NOTE: *When you select a size here, you are specifying the size of the staging area for data to be burned to the CD/DVD. If you select a size that is too large, you will be able to put more data in the staging area than will fit on your disc, and you will be unable to burn the data to a disc.*

Clip Storage and Cine Setup

You can use the **Clip Storage and Cine Setup** window to change how the Clip Browser and Cine functions work.

To open the Clip Storage and Cine Setup window:

- Click the **System** tab, and then the **Clip Storage/Cine** tab.

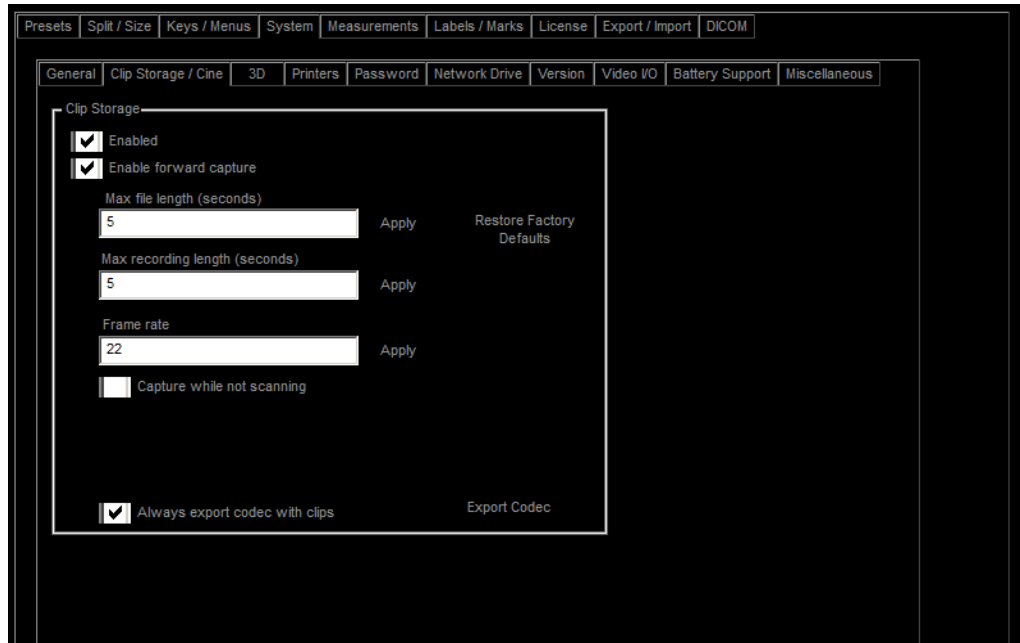

Figure C-5. The Clip Storage and Cine Setup window when forward capture is enabled.

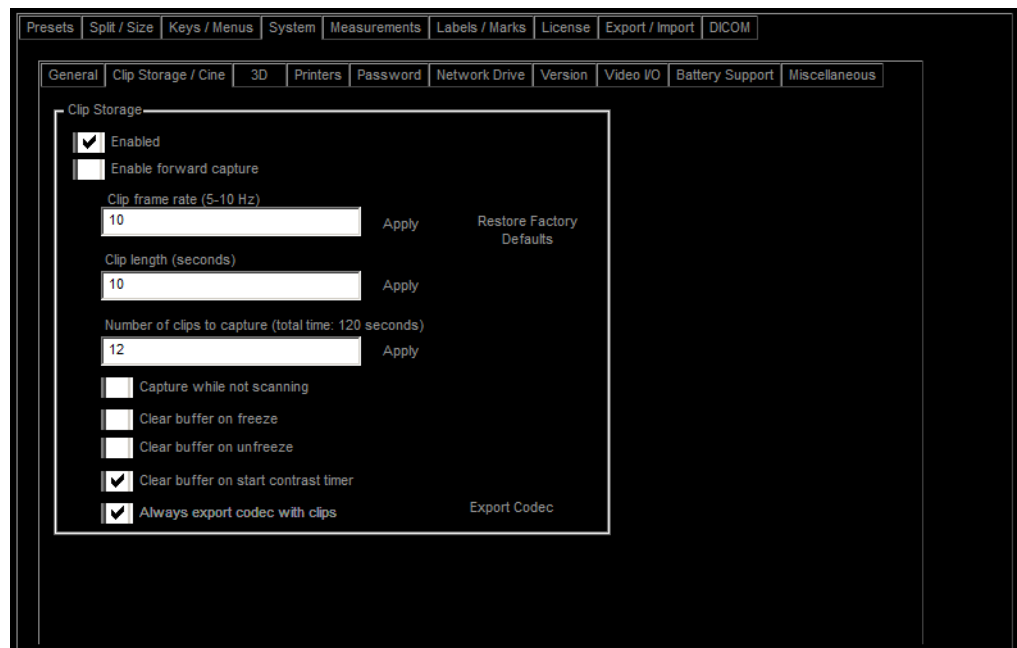

Figure C-6. The Clip Storage and Cine Setup window when forward capture is not enabled.

The options in the **Clip Storage and Cine Setup** window are explained in Table C-1.

Clip Storage and Cine Options

Option	What it does
Enabled	Enables clip storage on the system.
Enable forward capture	Enables clip capture to work like a recorder. Click to start and click to stop. When this is <i>not</i> checked, the captured clip is what has just happened before you clicked Capture .
Max file length (seconds)	You can record multiple clips, that is, split your recording into smaller files. This sets the length of an individual file.
Max recording length (seconds)	Sets a limit to the recording length. If forward capture is enabled and you do not click to stop the clip, the clip will stop when it reaches this length. Enter a length and click Apply . <i>Example: If you set Max file length to 15 seconds, and Max recording length to 45 seconds, and then click to record, the recording will stop after 45 seconds and you will have 3 clips of 15 seconds each.</i>
Frame rate	Sets the frame rate (from 5–22 Hz) for capturing clips. Enter a frame rate and click Apply .
Clip length	(This option is available only when forward capture is not enabled.) Sets the length of clips that are stored (in seconds). The maximum possible length depends on the frame rate you set. Enter a clip length and click Apply .
Capture while not scanning	When checked, you can capture clips while the image is frozen. When not checked, clip storage stops when you freeze the image.
Clear buffer on freeze	(This option is available only when forward capture is not enabled.) When checked, the clip buffer is cleared when you freeze the image.
Clear buffer on unfreeze	(This option is available only when forward capture is not enabled.) When checked, the clip buffer is cleared when you start imaging again.
Clear buffer on start timer	(This option is available only when forward capture is not enabled.) When checked, the clip buffer is cleared when you start the timer.
Always export codec with clips	When checked, the codec is exported every time you copy a clip to an external medium.
Restore Factory Defaults	Restores factory default clip storage or cine settings.
Export Codec	Exports the Clip Storage codec to a CD/DVD or USB device.
Activate on Freeze	When checked, cine starts when you freeze the image. (You can restore this setting to the factory default, too.)

Table C-1. Settings in the Clip Storage and Cine Setup window.

3D Setup

In the **3D Setup** window, you can:

- Specify whether the 3D system prompts you before deleting or overwriting user views and presets.
- Have the 3D ROI be automatically selected when you start 3D or when acquisition of a 3D data set is complete.
- Choose to see the 3D volume as it is being acquired instead of seeing only the 2D view until the dataset acquisition is complete.

To open the 3D Setup window:

- Click the **System** tab, and then, in the new window that appears, the **3D** tab.



Figure C-7. The 3D Setup window.

Printer Setup

You can set up the paper size for your printers in the **Printer Setup** window. You can also print a test page to check your settings. You can also set up an office printer on a network.

To open the Printer Setup window:

- Click the **System** tab, and then, in the new window that appears, the **Printers** tab.

NOTE: Click **Setup** in the **Printer Setup** window if you want to adjust the color, contrast, or brightness of a printer. Do not use this new window to change anything else because your settings will be overruled by the settings in the **Printer Setup** window.

In this window, you can also specify whether images printed with a USB printer are archived automatically. (If the patient ID is missing, the printed image is not archived.)

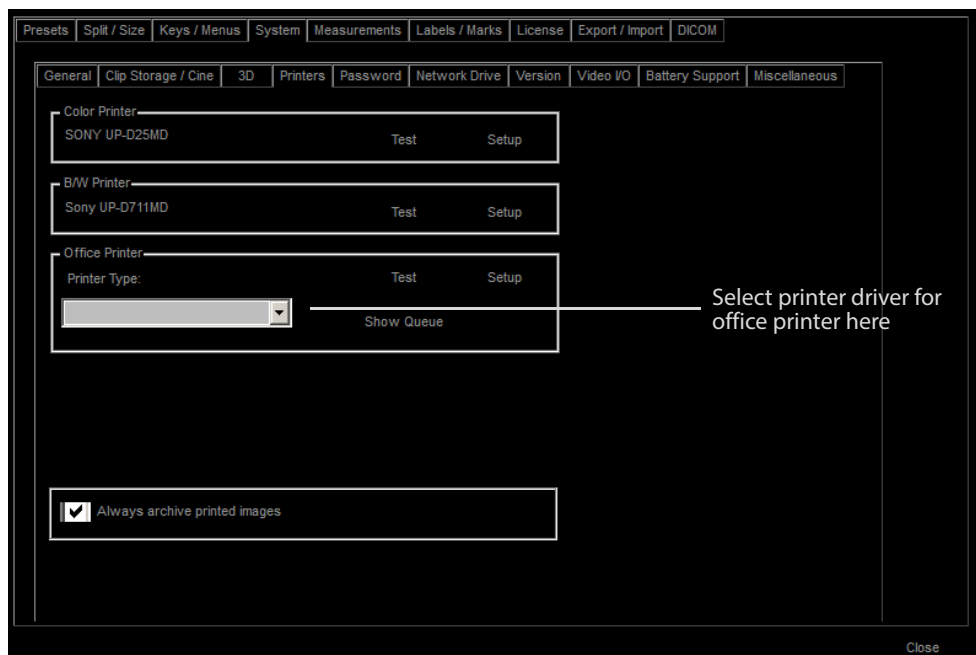

Figure C-8. The Printer Setup window.

Color Printer and **B/W Printer** are for thermal printers. An **Office Printer** means one that supports ordinary A4 or letter-size paper.

Setting Up an Office Printer

The Office Printer setup configures one of the pre-installed drivers (PCL5, PCL6 or PS) to work with the particular office printer you have configured.

NOTE: *You cannot connect an office printer directly to a USB connector on the system. You must connect it through a network. The only printers you can connect directly are the ones specified in the Product Data for the system.*

To set up an office printer:

- 1 Click **Setup**.
- 2 Give the printer a name in the **Printer Name** field.
- 3 Type the printer's IP address in the **Network Address** field.
- 4 Click **Install**.

The name you have given to the printer appears in the **Printer Name** field at the top of the window.

- 5 Click **Close**.

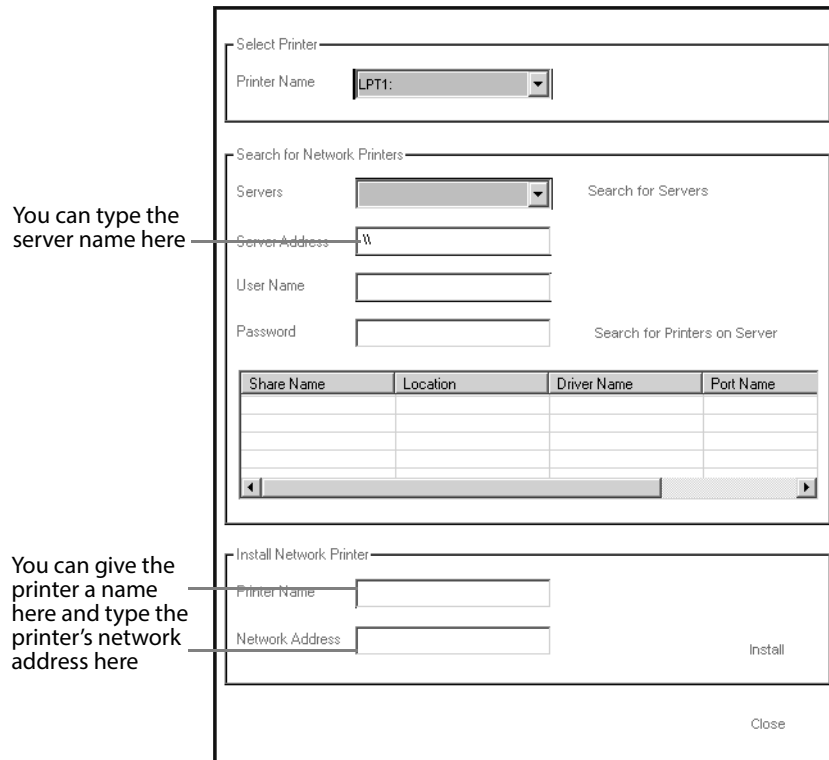

Figure C-9. The Printer Configuration window.

Password Setup

If your system is set up to be password-protected, use the **Password Setup** window to change your password. If you are a superuser with administrative privileges, you can add or remove users, reset their passwords, and enable or disable password protection.

NOTE: *Usernames and passwords must each be no longer than 16 characters. The username is not case-sensitive, but the password is case-sensitive. (Case-sensitive means that **B** is not the same as **b**.)*

The default superuser name and password are:

- Name: **administrator**
- Password: **superuser**

To open the Password Setup window:

- Click the **System** tab and then the **Password** tab.

The **Password Setup** window opens for you to change your password.

If password protection is disabled, then only the checkbox “Password Protection Enabled” (without a check) is displayed. Only a superuser can enable or disable password protection.

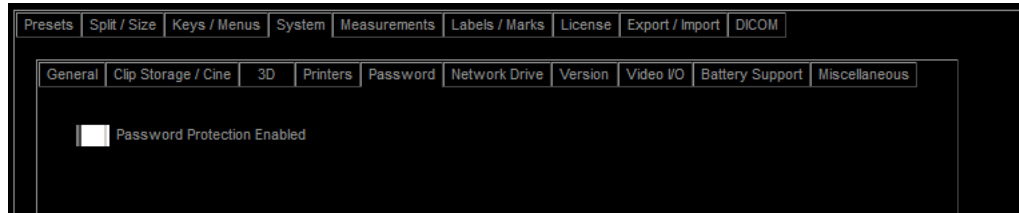

Figure C-10. Password Protection disabled.

Network Archiving

In the **Network Drive Setup** window, you can set up a network drive for archiving. Enter the UNC path to the network drive and your network username and password. You can leave the password blank, but then you will be prompted for it each time you try to access the network (unless you have the same usernames and passwords for the network and the system – see “Network Password” on page 60.)

To open the Network Drive Setup window:

- Click the **System** tab, and then, in the new window that appears, the **Network Drive** tab.

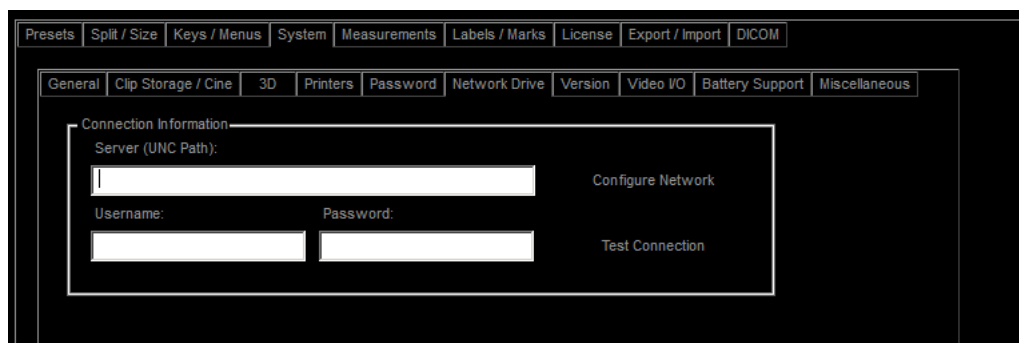

Figure C-11. The Network Drive Setup window.

Version Information

The **Version Information** window contains information about the software and hardware versions installed on your system.

You can also see how much free space is left on your hard disk.

In this window, you can also export a log file that contains information about the system since the last software upgrade. You can email this to your BK service representative, for example, if you need support.

To open the Version Information window:

- Click the **System** tab, and then, in the new window that appears, the **Version** tab.

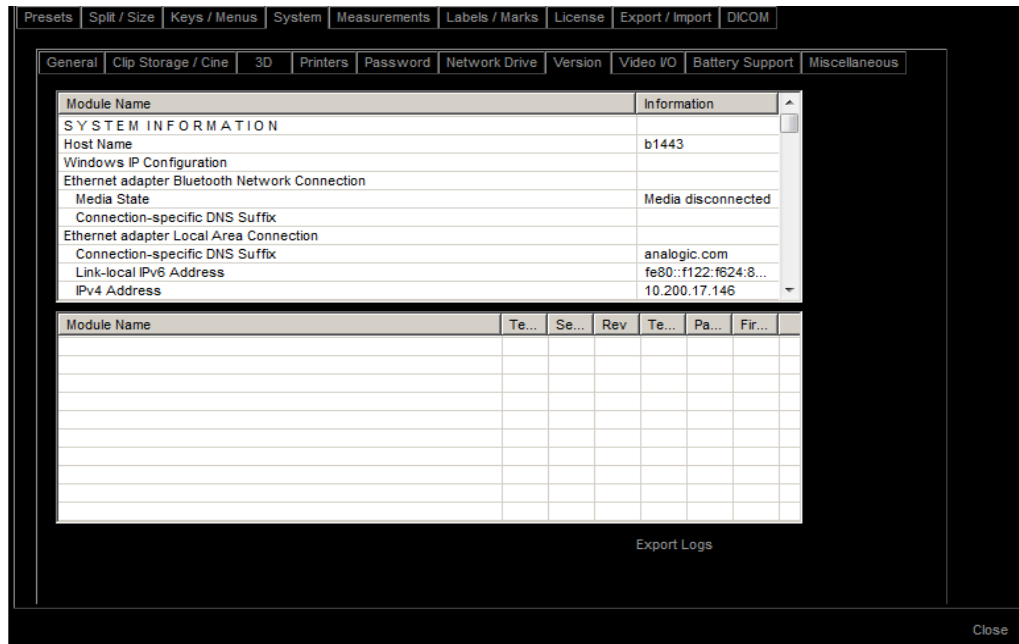

Figure C-12. The Version Information window.

To export a log file:

- 1 Insert a USB device into the system.
- 2 On the **Version** tab, click the ▼ that appears to the right for the drop-down menu **Export Logs**.
- 3 Select **USB Device**.
- 4 In the window that opens, click **Full** and type a comment, including the time and details about what you were doing when an error occurred.

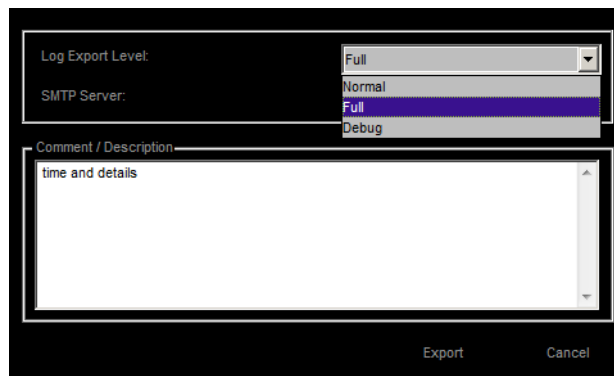

Figure C-13. The Export window.

- 5 Click **Export**.
A log file is created and copied to your USB device.
- 6 To send it to the BK Service department, zip the file and send it to support@bkmed.dk.

Video I/O Setup

Video I/O format (NTSC or PAL) is changed in the **General Setup** window (see page 251).

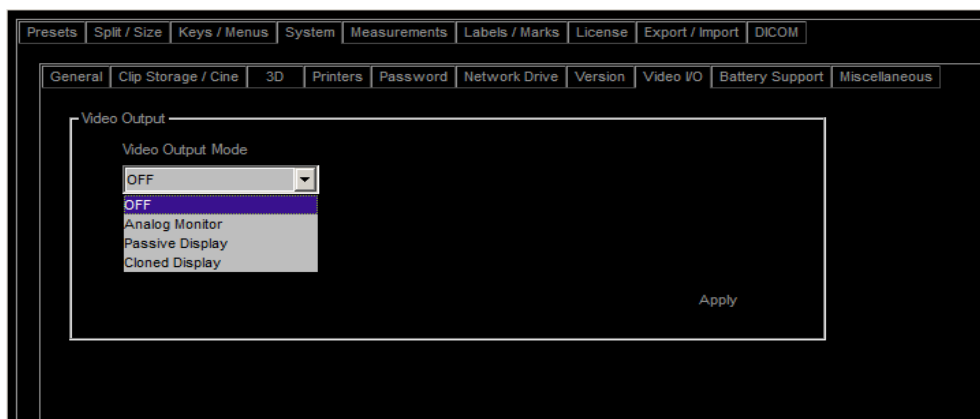

Figure C-14. The Video I/O Setup window.

In the **Video I/O Setup** window, you can specify the Video Output Mode:

- **OFF** – Video outputs are disabled. This is the default setting. If you are not using the video output, use this setting.
- **Analog Monitor** – Sends the video signal to S Video. The format is Passive Display.
- **Passive Display** – This gives a big ultrasound picture, but the not all of the rest of the system monitor is displayed. Patient name and ID are included, along with some settings and measurements.

With Passive Display, you can set the text font size and the color mode. Color mode is either Color or Black & White.

- **Cloned Display** – The video image is an exact copy of everything you see on the system monitor.

Because the system monitor is rotated to use a portrait mode display, the signal on the video output is also rotated 90°; this cannot be changed from the system. You must adjust this on the external equipment to avoid seeing the video image rotated.



Figure C-15. Cloned video display if external monitor is not rotated.

The cloned display output has an aspect ratio of 4:5. You must adjust your external equipment for that ratio to avoid a pixilated image. The resolution on the internal monitor is 1024x1280. (This is because the monitor, with a standard resolution of 1280x1024, has been rotated 90°.)

After you make any changes in this window, click **Apply**.

NOTE: Changes will not take effect until you restart the system.

Battery Support Setup

You can customize the battery operation in the **Battery Support Setup** window¹.

In the **Battery Support Setup** window, you can define the use of

- Power save mode (also on systems without battery support)
- Alarms (for low and critical low battery)
- Power profile

To open the Battery Support Setup window:

- Click the **System** tab, and then, in the new window that appears, the **Battery Support** tab.

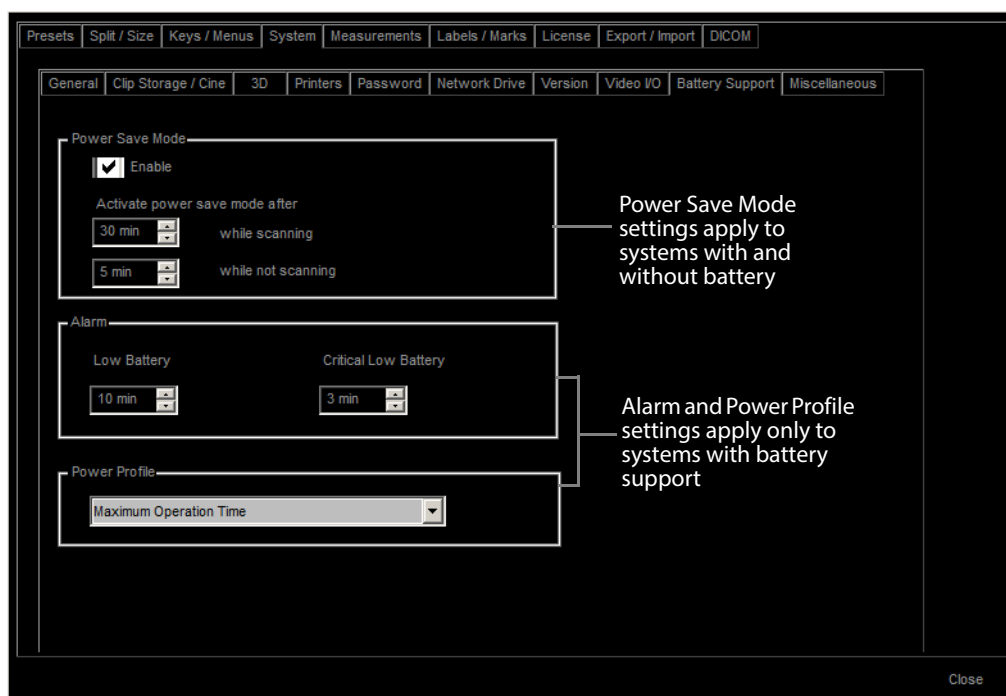

Figure C-16. The Battery Support Setup window.

Power save mode operates differently on systems with and without battery support.

Without battery support, the system ‘freezes’, the LCD backlight decreases and the monitor stays **on**.

With battery support, the system reacts differently depending on whether the external video is enabled or disabled:

1. The battery solution on the bk3000 and bk5000 has not been licensed by Health Canada.

Systems with battery support	Monitor	System
External Video Out enabled (active)	LCD backlight decreases, monitor stays on	"freezes"
External Video Out disabled (inactive)	Monitor turns off	"freezes"

Table C-2. Power Save Mode on battery supported systems.

Power-save mode is set/enabled by default in the factory. You can define these settings:

- Enable or disable power save mode.
- Set the number of minutes after which power save mode will be activated while imaging or while not imaging.

You can define when alarms (messages on the monitor) should be triggered to warn about low or critically low battery charge.

- **Low battery** – When the battery is low on charge, this alarm is triggered to warn the user that only x number of minutes of charge remain in the battery.
- **Critical low battery** – When the battery is critically low on charge, the system initiates shut down. The default setting is 3 minutes.

When either of these alarms are triggered, the user must take action to recharge the battery by plugging in to a power source.

You can decide how to power your system in the **Power Profile** field.

- **Maximum Operation Time** enables you to use the battery to the fullest extent. This is the factory default setting.
- Select **Maximum Battery Life** if you want to save battery and optimize battery lifespan. This is also considered better for the environment. Here, charging is inhibited if a battery charge level is greater than 80%.

For more information about using the battery support, see *bk3000 & bk5000 User Guide*.

Miscellaneous System Setup

You can use the **Miscellaneous System Setup** window to customize a variety of functions.

To open the Miscellaneous System Setup window:

- Click the **System** tab, and then, in the new window that appears, the **Miscellaneous** tab.

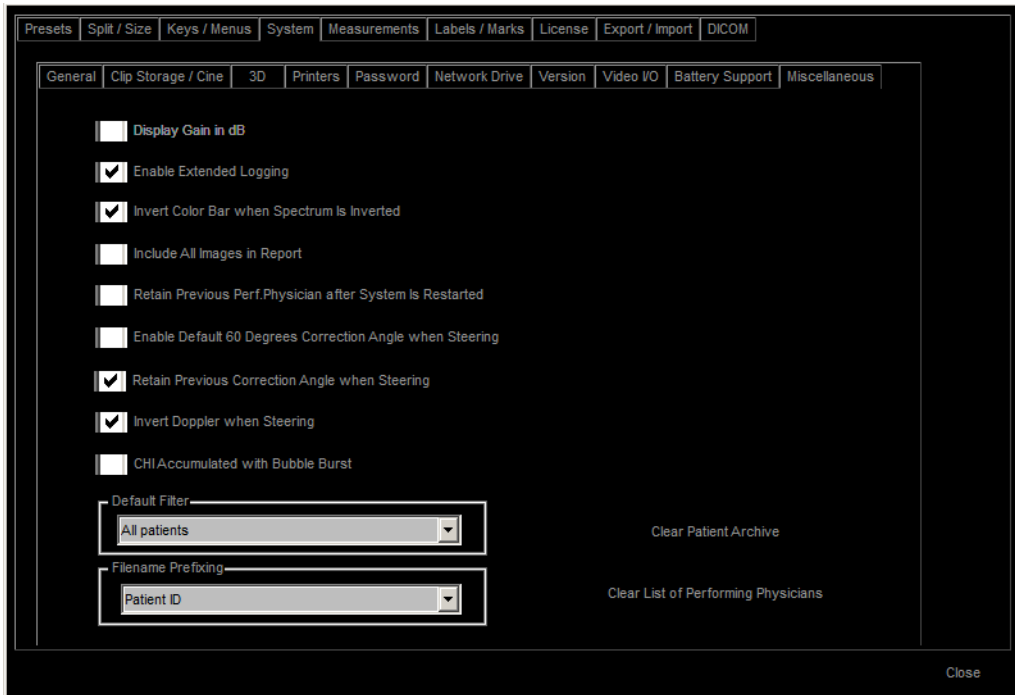

Figure C-17. The Miscellaneous System Setup window.

Option	What it does
Display gain in dB	If checked, gain is displayed in dB. If unchecked, gain is displayed as a percentage.
Enable Extended Logging	Enables extended logging.
Invert Color Bar when Spectrum Is Inverted	Inverts the color bar to correspond to inverted spectrum.
Include All Images in Report	If checked, all images are saved to a report. If unchecked, only selected images are saved to the report.
Retain Previous Perf. Physician after System is Restarted	Keeps the setting for performing physician so you don't have to enter it the next time you start the system.
Enable Default 60 Degrees Correction Angle when Steering	Sets correction angle to 60 degrees when steering is enabled or changed. If unchecked, the correction angle is independent of steering.
Retain Previous Correction Angle when Steering	Use the correction angle that used the last time steering was enabled.
Invert Doppler with Steering	Keeps the same state of the Doppler when steering changes.
Default Filter	Sets a default filter to filter the patients displayed in the Examination List on the monitor. You can use this to show only the current patient.
Filename Prefixing	You can select either patient ID, last name or comments as the prefix to the filename for all exported files and reports, to make identification and sorting easier.
Clear Patient Archive	Clears the entire patient archive. Doing this requires a password.
Clear List of Performing Physicians	Clears all the names of performing physicians.

Table C-3. Settings in the Miscellaneous System Setup window.

Measurements

You can customize the measurement setup so that each Pro Package contains exactly the measurements you want to use.

You can:

Use the **Measurement Definition Setup** window (page 265) to import and export measurements and define new measurements.

Use the **Curve Setup** window (page 270) to define a new curve or edit an existing one.

Use the **Miscellaneous Measurement Setup** window (page 273) to set various measurement parameters and change the way in which measurements are displayed.

User-Defined Measurements

Type of User-Defined Measurement	Measurement Based On This	About the Calculation	Results
B-Mode Measurement	1 or no B-mode measuring tool	Formula can use results of other measurements	1
D-Mode Measurement	1 or no Doppler mode measuring tool	Formula can use results of other measurements	1
Fetal Weight	1 or more results of other measurements	User-defined formula	FW
Gestational Age	1 B-mode measuring tool	GA and EDC calculated from factory-default or user-defined curve	<type> GA EDC
M-Mode Measurement	1 or no M-mode measuring tool	Formula can use results of other measurements	1
Procedure	Any measurements	User-defined sequence of measurements to be performed in order, for example, first "Height", then "Width", then "Length"	A sequence of measurements

Table C-4. Types of user-defined measurements and their properties.

To open the **Measurement Definition Setup** window, which displays a list of all user-defined measurements:

- Click the **Measurements** tab and then the other **Measurements** tab.

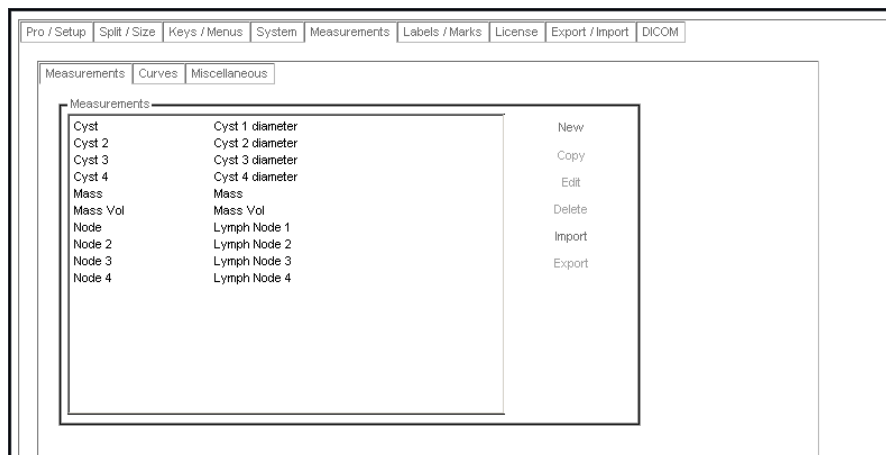

Figure C-18. The Measurement Definition Setup window.

You have the following options in the **Measurement Definition Setup** window:

Option	What it does
New	Opens the Measurement Definition Wizard so you can define a new measurement.
Copy	Creates a new user-defined measurement as a copy of the currently selected measurement. You must enter a new name and description. You can then edit it to create a new user-defined measurement.
Edit	Opens the Measurement Definition Wizard so you can edit the selected user-defined measurement.
Delete	Deletes the selected user-defined measurement. You are asked to confirm the deletion.
Import	Imports a measurement from an external storage device. If the measurement depends on other measurements, you are prompted to import them, too.
Export	Exports a measurement to an external storage device. Note: <i>If the measurement depends on other measurements, they will not be exported automatically. You must do this manually by selecting user-defined ones for export. Factory-defined measurements do not need to be exported because they will exist on all systems.</i>

Table C-5. Options in the Measurement Definition Setup window.

Using the Measurement Definition Wizard

To define a new measurement or edit an existing one:

- 1 In the **Measurement Definition Setup** window, click **New** (or select an existing measurement and click **Edit**.) The following window appears (when you click **New**).

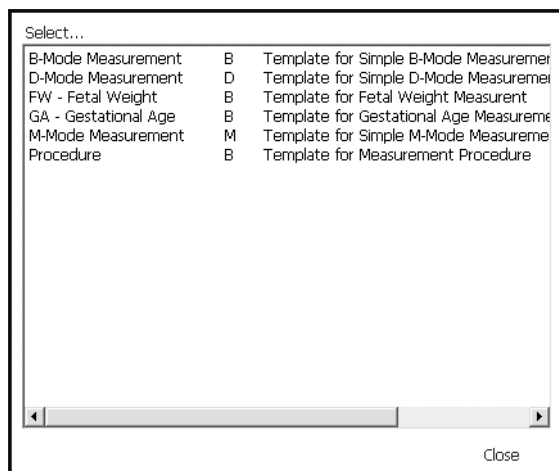

- 2 Select a template that the measurement will be based on. (This step does not appear if you are editing an existing measurement.)

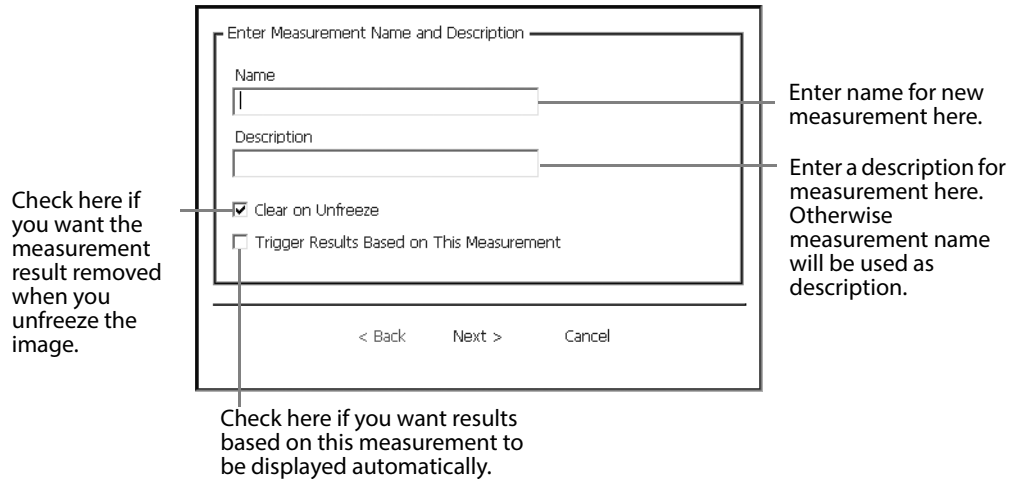

- 3 Enter a name and description for the new measurement (or edit the existing measurement). Decide whether you want the measurement result to be removed when you unfreeze the image. If you use measurements made on images from different imaging planes, you probably do *not* want it removed. Click **Next**.

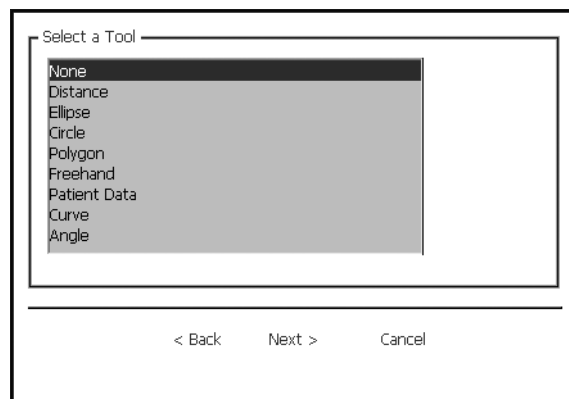

- 4 Select a measuring tool. (Fetal weight measurements and procedures skip this step and go straight to Step 5.) The tools that are available depend on the type of measurement you are defining. Click **Next**.

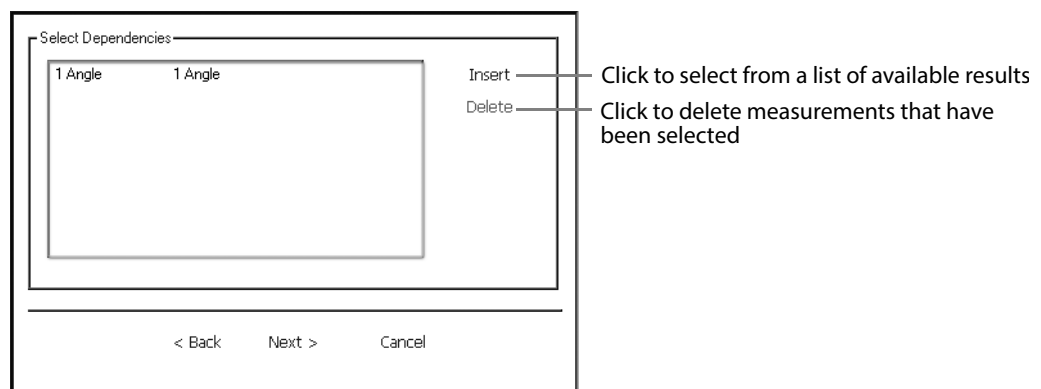

- 5 Select dependencies, one at a time. (Gestational age measurements skip this step and go to Step 6.) That is, click **Insert** and select the measurements whose results will be used by the new measurement. Click **Next** and jump to Step 7.

(If you are defining a procedure, select, in order, the measurements that will make up the procedure. Then click **Finish** and jump to Step 9.)

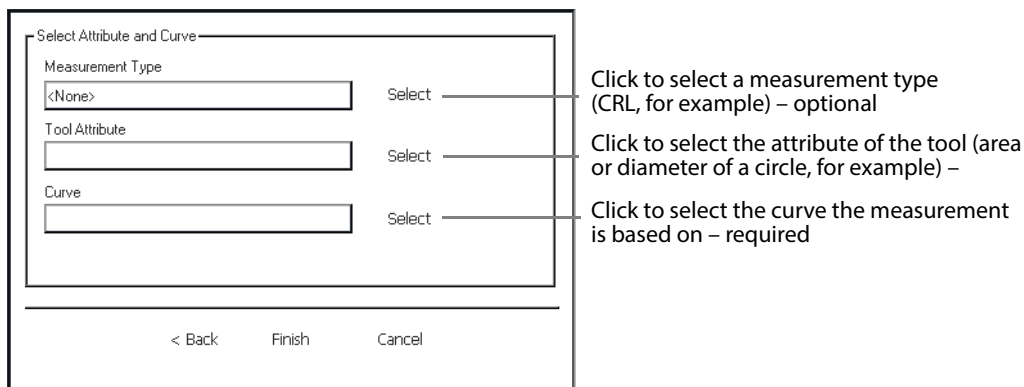

- 6** For gestational age measurements only, select a measurement type (optional), tool attribute (required) and curve (required). Go to Step 8.

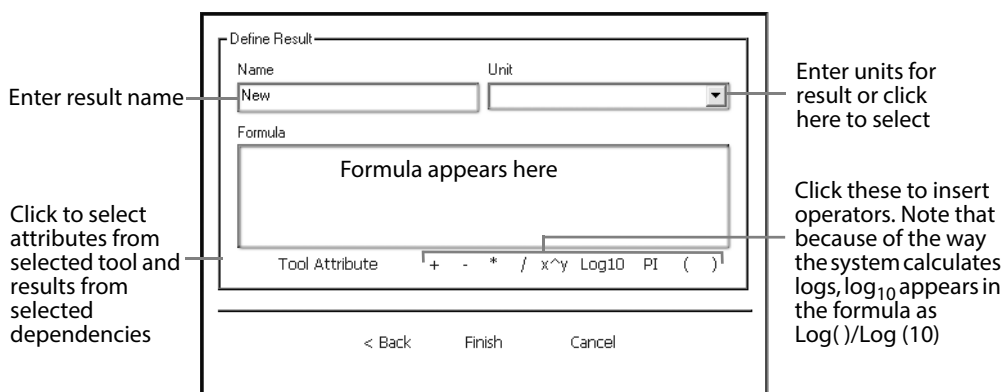

- 7** Define the name and units of the result of the measurement. Then define the formula for the measurement. The formula must follow the syntax in Table C-6. An example of a formula is:

$3.1419 * ([Distance.Distance_mm] / 2) ^ 2$
 (Gestational age measurements skip this step.)

Part of Formula	Syntax
Tool	[<tool name>.<attribute value>]
Dependency	[<dependency name>.<dependency result name>]
Argument list (ARG_LIST)	<tool name>.<attribute value> or <tool name>.<attribute value>,ARG_LIST or <tool name>.<dependency result name> or <tool name>.<dependency result name>,ARG_LIST

Table C-6. Formula syntax for measurements.

- 8** Click **Finish**. (If the formula contains errors, you will not be able to continue until you correct them.)

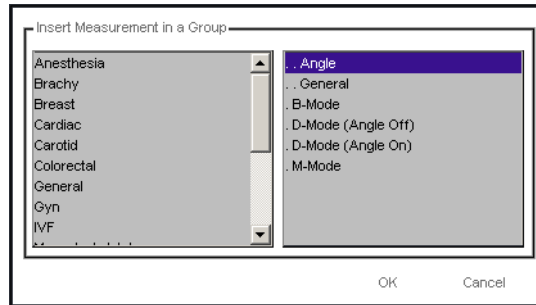

1. Select a Pro Package here

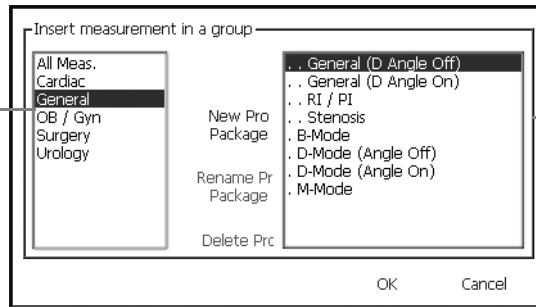

2. Then select the group you want your measurement to belong to

- 9 If you are defining a new measurement, insert it into a measurement group for the selected Pro Package by selecting the Pro Package and then the measurement group.
 You can also edit measurement groups in the **Measurement Group Setup** window.

Curves

You use the **Curve Setup** window to define a curve or to edit an existing user-defined one.

To open the Curve Setup window:

- Click the **Measurements** tab and then the **Curve** tab.

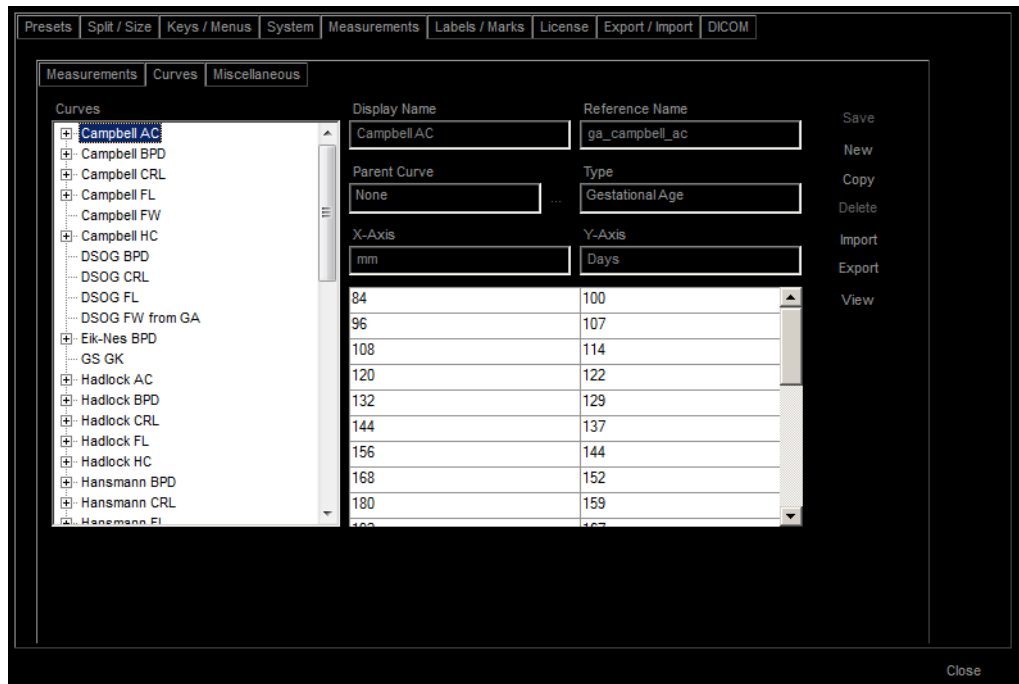

Figure C-19. The Curve Setup window.

The **Curve Setup** window has a list of curves on the left, fields containing information about the curves in the middle, and a list of options on the right.

The list contains all available curves, including all user-defined ones. The list is displayed in the form of a “tree”. If a curve appears with a + to the left of it, it has related (percentile) curves that will be displayed with it. Click on the + to expand the tree and see the related curves. The + becomes a - when the list is expanded. Click - to collapse the list again.

NOTE: The percentile curves are called “child” curves. The curve that they are related to (and displayed with) is called the “parent” curve.

When the window opens, no curve is selected, and the information fields are blank.

When a curve in the list is selected, the information fields contain information about the selected curve. If the selected curve is user-defined, you can edit the information in the fields.

The actual values of the curve are listed below the other information fields.

Information Field	Contents
Display Name	The name you give the curve. It will appear with this name on the system. You are warned if you try to give a curve a name that is not unique, but you can do it anyway.
Reference Name	The reference name is used to reference curves from measurement formulas. The reference name must be unique. That will be checked when you click Save .
Parent Curve	The parent curve that will be displayed with the curve you are defining. Click to select a parent curve from a list.
Curve Type	<p>The type of curve:</p> <ul style="list-style-type: none"> • Gestational Age • Fetal Weight From Gestational Age • None (some other type or not a specific type) <p>Measurements based on a GA-curve will be available in the reports. The default FW-curve will also be available in the reports.</p>
X-Axis	A label for the x-axis of the curve.
Y-Axis	A label for the y-axis of the curve.
Curve Values	<p>The curve values are entered in the spreadsheet-like control at the bottom of the dialog. The left column is the x-axis and the right column the y-axis.</p> <p>You do not have to enter the values in a sorted order. The database will sort the x-values ascending. If a cell in the left column is empty, the y-value next to it is not used.</p> <p>There is no limit to the number of values you can enter to define a curve.</p>

Table C-7. Information fields in the Curve Setup window.

You have the following options in the **Curve Setup** window.

Option	What it does
Save	Saves a curve that you have edited or defined.
New	Blanks all the curve values so you can insert new ones to create a new curve.
Copy	Creates a copy of the selected curve. Child curves are not included in the copy and must be copied separately. Curve Type , X-axis, Y-axis and points are copied. Display Name , Reference Name and Parent Curve are left blank so you can fill them in to create a new curve.
Delete	Deletes the selected curve. If the selected curve is a parent curve the children will be deleted as well. You are asked to confirm that you want to delete the curve.
Import	Imports a curve from an external storage device.
Export	Exports a curve to an external storage device. If the curve is a parent curve, the children will be exported as well.
View	Displays the currently selected curve. The curve dialog is opened and curve is displayed. This is very useful for verifying that curve points are positioned correctly.

Table C-8. Options in the Curve Setup window.

Creating and Editing Curves

To create a new curve:

- 1 Open the **Curve Setup** window.
- 2 Click **New**.
- 3 Fill in the information fields and the values you want for the curve.
- 4 Click **Save**.

To edit an existing curve:

- 1 Open the **Curve Setup** window.
- 2 In the list on the left, click the curve you want to edit.
- 3 Edit the information fields (including the curve values) as you want to.
- 4 Click **Save**.

NOTE: You can only edit curves that you have defined. Curves that come with the system cannot be edited.

Miscellaneous Measurement Setup

To open the Miscellaneous Measurement Setup window:

- Click the **Measurements** tab and then the **Miscellaneous** tab.

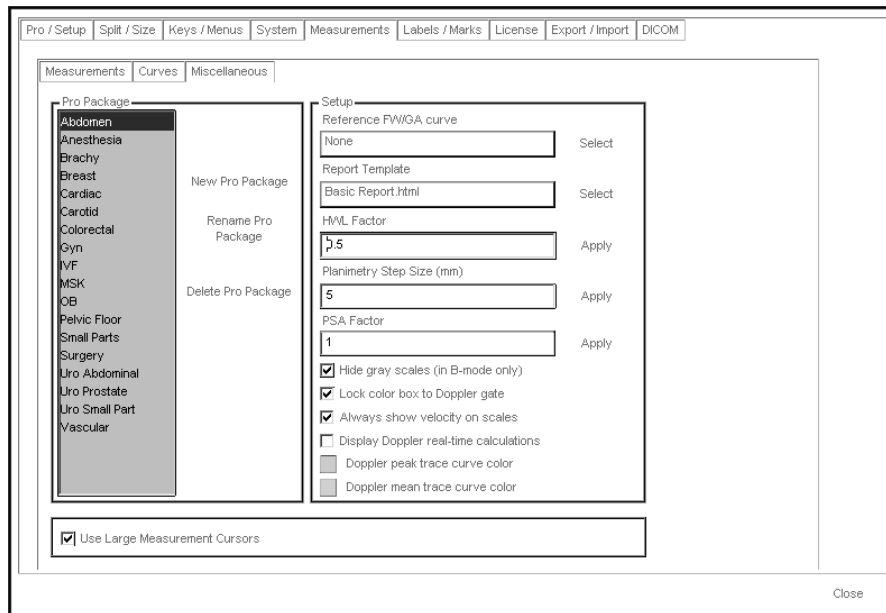

Figure C-20. The Miscellaneous Measurement Setup window.

In this window, you can specify:

- The FW/GA curve that is used as a reference curve when you create a report.
- The report template that will be used for the Pro Package that is selected.
- The HWL factor.
- The planimetry step size.
- The PSA factor.
- Whether gray scales are hidden in B-mode.
- Whether the color box is locked to the Doppler gate – if you leave this box unchecked, the color box will not move when you drag the Doppler gate.
- Whether Doppler and Color measurements are always shown in cm/s (velocity) or whether they are in kHz when the Doppler angle correction is turned off.
- Whether Doppler real-time calculations are displayed all the time.
- The color for the Doppler peak or mean trace curve – to change the color, click the colored box and select the color you want.
- Whether you want displayed measurement cursors to be larger.

NOTE: Make sure to select the appropriate Pro Package on the left side of the window before defining the settings.

Marks (Bodymarks, Labels, Puncture Guides)

You can customize the bodymark and label setup. You can also change the offset of a programmable brachy matrix puncture guide or set up a brachy ruler. For each Pro Package, you can:

- Import new bodymarks/labels into any bodymark/label catalog
- Copy bodymarks from one catalog to another
- Delete bodymarks/labels from a catalog
- Change the order in which bodymarks/labels in a catalog are displayed
- Set a default position for bodymarks (and imaging plane indicator) and labels

Bodymark Setup

To open the Bodymark Setup window:

- Click the **Labels/Marks** tab, and then, in the window that appears, the **Bodymark Catalogs** tab.

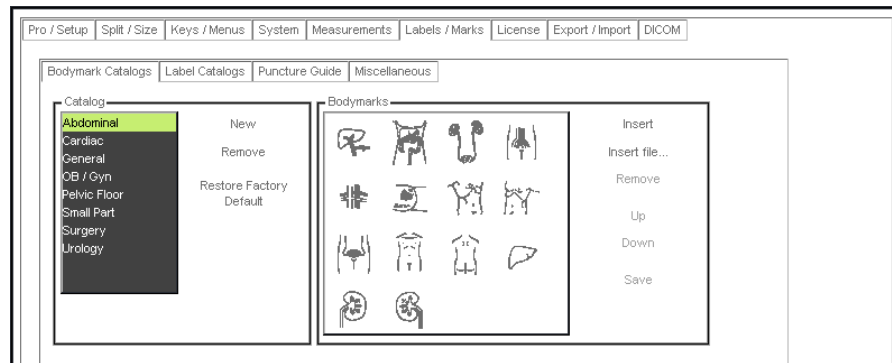

Figure C-21. The Bodymark Setup window.

Label Setup

To open the Label Setup window:

- Click the **Labels/Marks** tab, and then, in the window that appears, click the **Label Catalogs** tab.

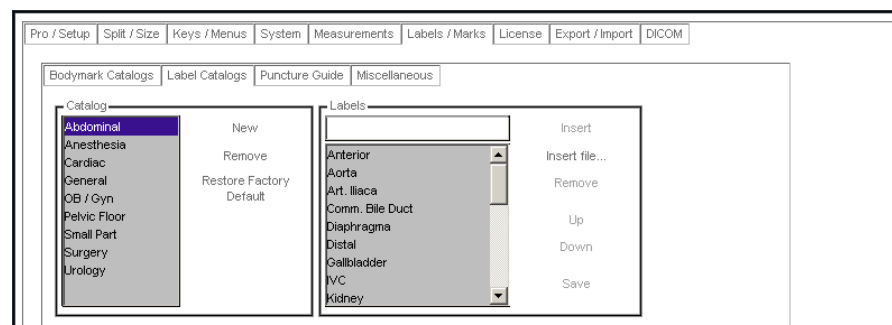

Figure C-22. The Label Setup window.

Transperineal Matrix, Brachy Matrix and Ruler, and Programmable Puncture Guide Setup

In the **Brachy Matrix Setup** window, you make setup changes to brachy matrices and puncture guides. You can:

- Move a programmable brachy matrix or puncture guide left, right, in or out. Specify that a brachy ruler is displayed on a sagittal view (E14CL4b transducer).
- Define your own brachy matrix and ruler.

To open the Brachy Matrix Setup window:

- Click the **Labels/Marks** tab, and then, in the window that appears, the **Puncture Guide** tab.



Figure C-23. The Brachy Matrix Setup window.

To move the offset in either direction:

- Select the offset you want from the drop-down menu and click **Save**.

 Offset changes	<p>WARNING P-w3</p> <p>Changes you make to the offset of a programmable puncture guide or brachy matrix will affect ALL programmable puncture guides and brachy matrices. This could lead to incorrect puncture lines or matrix positions for a different guide than the one you wanted to change.</p>
--	---

To have a vertical line displayed at the 0 of the brachy ruler:

- Check the checkbox and click **Save**.

User-Defined Matrices (including Brachy and Transperineal)

 Verify user-defined guide	<p>WARNING B-w2</p> <p>If you create a user-defined matrix, it is your responsibility to verify that the matrix that appears on the monitor corresponds to the physical matrix you are using.</p>
---	--

User-defined matrices are listed in the lower part of the **Brachy Matrix Setup** window (Fig C-23).

You have the following options for user-defined matrices:

Option	What it does
New	Opens the User-Defined Matrix Wizard so you can define a new matrix.
Copy	Creates a new user-defined matrix as a copy of the currently selected matrix. The name of the new matrix is the name of the existing matrix plus an index number. You can then edit the copy to create a new user-defined matrix.
Edit	Opens the Measurement Definition Wizard so you can edit the selected user-defined brachy matrix.
Delete	Deletes the selected user-defined matrix. You are asked to confirm the deletion.
Import	Imports a matrix from an external storage device. If the system already has a matrix with the same name as the matrix you want to import, the imported matrix will be renamed to the matrix name plus an index number.
Export	Exports the selected matrices to an external storage device.

Table C-9. Options in the Brachy Matrix Setup window.

Using the User-Defined Matrix Wizard

To define a new matrix or edit an existing user-defined matrix:

- 1 In the **Brachy Matrix Setup** window, click **New**, or select an existing measurement and click **Edit**.

The following window appears:

The screenshot shows a dialog box titled "General Matrix Information". It contains two fields: "Transducer Type" with a dropdown menu showing "E14CL4b" and "Matrix Name" with a text input field containing "MyBrachyMatrix". Below the fields is a horizontal line, and at the bottom are three buttons: "< Back", "Next >", and "Cancel".

- 2 Select the transducer that the matrix will be used with, and name the matrix. Click **Next**.

Transverse Matrix - Dimensions

Width in mm	Horizontal holes/cm	Horizontal offset in mm
70	2	0
Height in mm	Vertical holes/cm	Vertical offset in mm
70	2	0

Columns: 15
 Rows: 15
 Column spacing: 5.00 mm
 Row spacing: 5.00 mm

< Back Next > Cancel

- Enter the width and height of the matrix, the horizontal and vertical spacing between holes (holes per cm), and the horizontal and vertical offset of the matrix.

The system calculates the number of rows and columns and the hole spacing in each direction. When the both offsets are 0, the matrix looks like this:

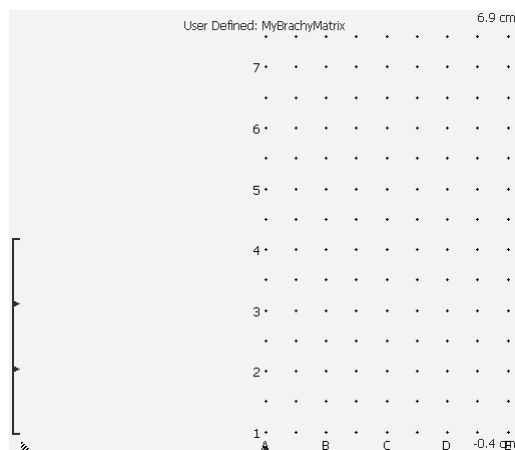

Assuming that the transducer is at the bottom of the image, positive offsets move the matrix to the right or up, negative offsets move it to the left or down.

- Click **Next**.

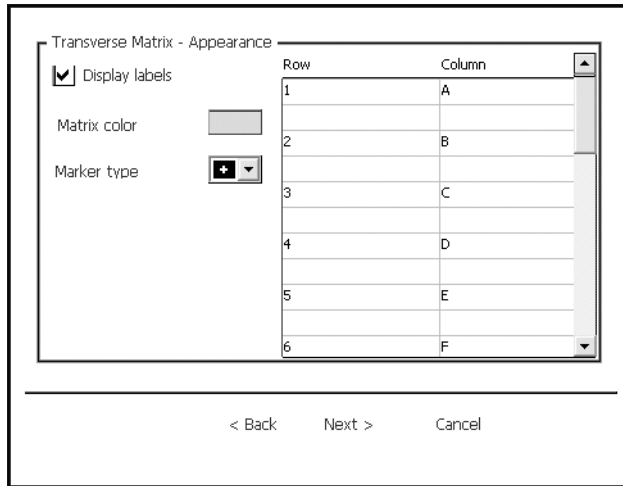

- 5 Select the symbols (**Marker type**) and color (click the box) that will be used for the matrix. If you check **Display labels**, you can enter names for the rows and columns. Click **Next**.

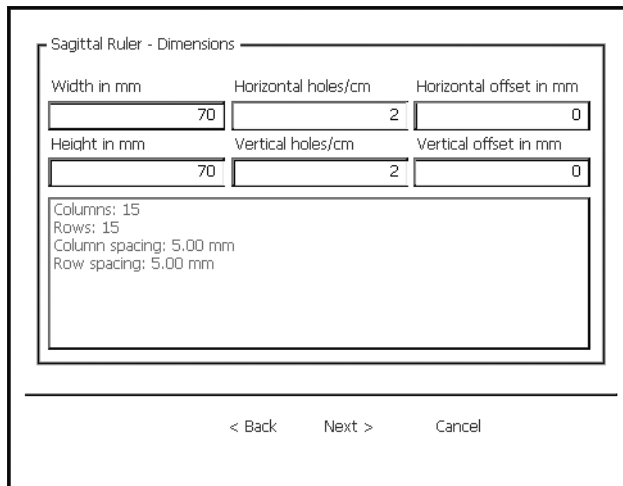

- 6 Enter the width and height of the ruler, the horizontal and vertical spacing between markers (holes/cm) and the horizontal and vertical offset of the ruler. The system calculates the number of rows and columns and the hole spacing in each direction. When the both offsets are 0, the matrix looks like this:

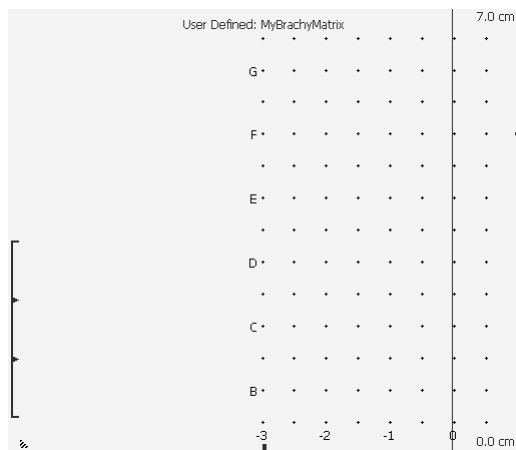

Assuming that the transducer is at the bottom of the image, positive offsets move the matrix to the right or up, negative offsets move it to the left or down.

Click **Next**.

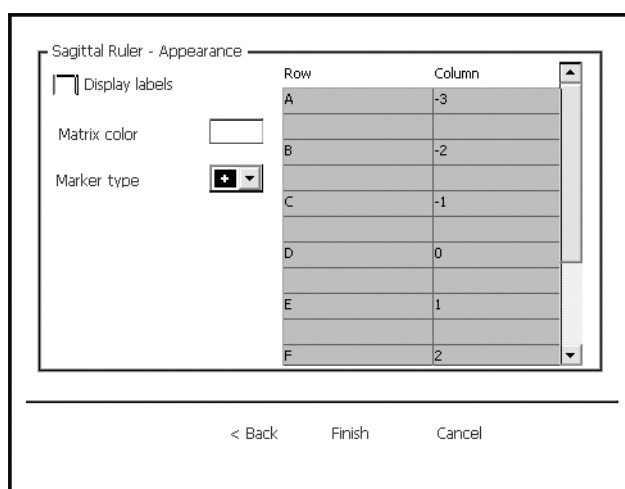

- 7 Select the symbols (**Marker type**) and color (click the box) that will be used for the ruler. If you check **Display labels**, you can enter names for the rows and columns.

NOTE: If you want to be able to have a vertical line displayed at the 0 of the brachy ruler (see page 275), you must name one of the columns “0”.

- 8 Click **Finish**.

NOTE: You must disconnect and reconnect the transducer (both plugs, if it has more than one) for the changes to take effect.

Matrix Alignment and Calibration

	<p>WARNING B-w4</p> <p>To avoid harming the patient, check the needle alignment (and recalibrate if necessary) before each use.</p>
--	--

NOTE: The best accuracy that can be expected is a 3 mm deviation.

Check the alignment of a reusable puncture guide or transperineal biopsy matrix if you have any reason to suspect that it has been damaged. BK Medical recommends that you check them once a month, or more often in case of heavy use.

To check the alignment of puncture guides and matrices:

- 1 Fill a suitable tank with saline. The concentration of the saline depends on the room temperature. It should be 4% NaCl at 25°C (77°F) and 5% NaCl at 20°C (68°F).
- 2 Assemble the puncture guide (or brachy stepper and grid) and attach it to the transducer.
- 3 Turn on the system and connect the transducer.
- 4 Immerse the transducer tip in the saline.
- 5 Start imaging to produce an image on the monitor.

- 6 Press  on the control panel to superimpose the puncture line or matrix on the monitor image.
- 7 Insert a needle through the puncture guide or grid.
- 8 Watch the image of the needle tip and measure its deviation from the puncture line or matrix point shown on the monitor.
- 9 Decide whether the accuracy is acceptable.
- 10 If the accuracy is not acceptable, contact your BK Medical service representative.

To calibrate programmable matrices:

- 1 Fill a suitable tank with saline. The concentration of the saline depends on the room temperature. It should be 4% NaCl at 25°C (77°F) and 5% NaCl at 20°C (68°F).
- 2 Turn on the system and connect the transducer.
- 3 Make sure that the correct transducer type number is displayed the top of the monitor, followed by **T**, indicating that you are imaging in the transverse plane.
- 4 Press  on the control panel to superimpose the matrix on the monitor image.
- 5 Click **brachy 5 mm** at the top of the image area.
The **Puncture Guide** menu appears.
- 6 Click the matrix you want to calibrate.
- 7 Mount the transducer in the holder, by twisting the probe in, and put the transducer pin in the slot on the holder.
- 8 Then put the transducer (mounted in the holder, and with the grid attached) into the saline, making sure that the transducer arrays are fully immersed.
- 9 Verify that there is a image on the monitor, and that the image isn't frozen.
- 10 Insert a needle through hole D4 in the grid.
The needle echo appears on the monitor.
If the echo is superimposed on the dot in the matrix on the monitor, then insert a needle through B4 and F4. If the echo for the needles in these holes are also in the correct position, no further adjustment is required.
- 11 If the needle echo is not in the correct position relative to the matrix on the monitor, open the setup windows. On the **Image** tab, click **Advanced**, then **Customize**.
- 12 Click the **Labels/Marks** tab, and then, in the window that appears, the **Puncture Guide** tab.
- 13 Here you will be able to move the template to the right or to the left, and in and out. (In = closer to the transducer/down on the monitor; Out = farther from the transducer/up on the monitor.)
- 14 Whenever you make changes to the matrix, remember to save your settings. Then repeat the process from step 10 to verify that the needle echo is superimposed on the correct dot in the matrix.
- 15 It may be necessary to adjust the stepper as well. Consult the stepper user guide for instructions. After you adjust the stepper, use the earlier steps in this procedure to verify that the matrix is calibrated properly.

**WARNING** Check-w1

To ensure safe operation, do not use the equipment if you find any signs of damage. Contact your BK Medical service representative.

Miscellaneous Marks Setup

You can customize some aspects of how bodymarks and labels work for each Pro Package in the **Miscellaneous Marks Setup** window.

To open the Miscellaneous Marks Setup window:

- Click the **Labels/Marks** tab, and then, in the window that appears, the **Miscellaneous** tab.
- Select the Pro Package in the left pane and make your changes under Setup in the right pane.

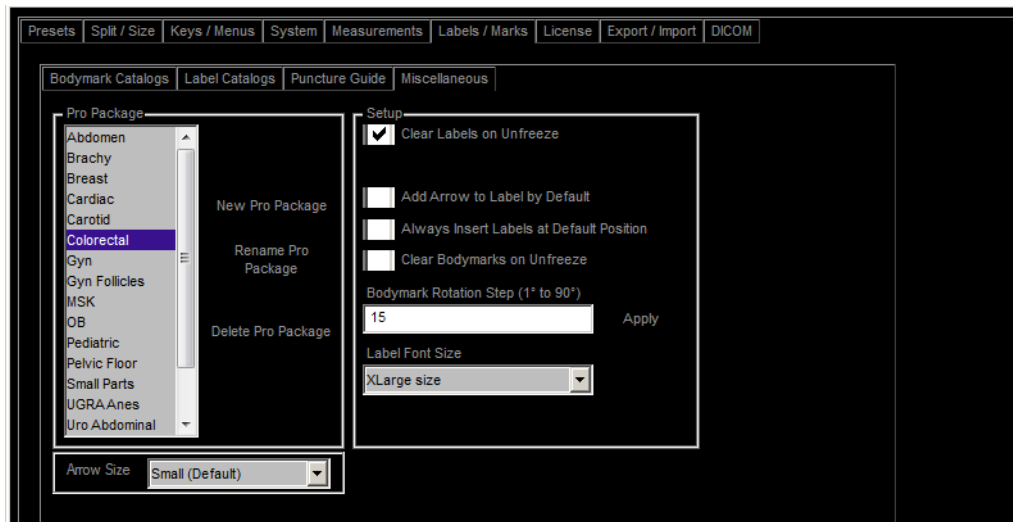

Figure C-24. The Miscellaneous Marks Setup window.

Changes you can make to labels and bodymarks in a Pro Package:

- 1 Set labels or bodymarks to be cleared when you begin imaging after the image has been frozen.
- 2 Set the system to attach an arrow to each label automatically.
- 3 Set the system to always insert labels at the position you have defined as default. When this box is unchecked, labels are placed where the mouse cursor is. (However, if the cursor is outside the image or you are using the **Label** window to insert the label, the label is inserted at the default position.)
- 4 Change the step size per click that is used when you rotate the imaging plane indicator. Step sizes can range from 1° to 90°. Type the number (but not the degree symbol) for the new step size and click **Apply** (or press **Enter**.)
- 5 Set the font size for labels to make it easier to read their information.
- 6 Select the size of your arrow.

Licenses

Some functions of the bk3000 and bk5000 are optional; you must have a specific license to use them. The available options also depend on the system version you purchased.

When you purchase an option, you receive a 16-character license key. To activate the option, you must type the license key into the **License Manager** window.

To add a license:

- 1 Click the **License** tab.

The **License Manager** window opens.

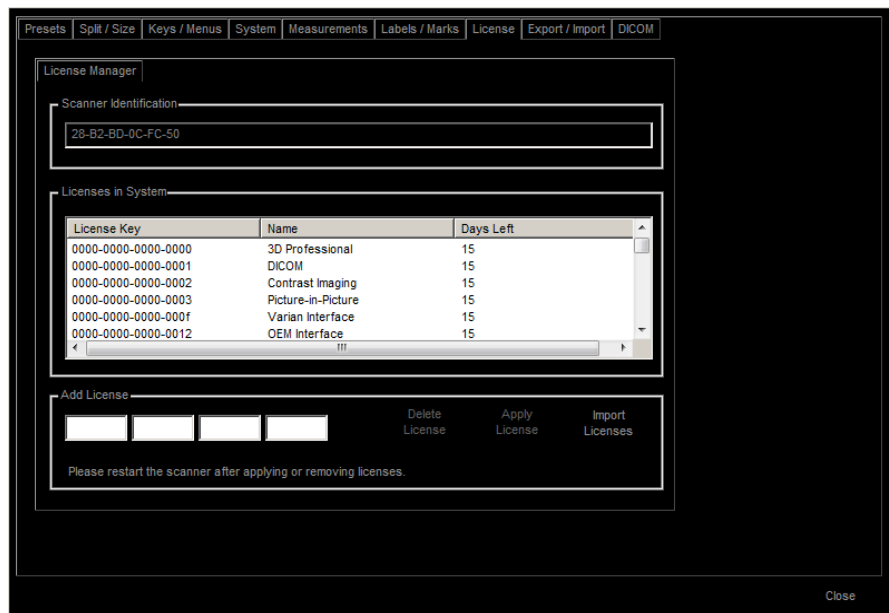

Figure C-25. The License Manager window.

- 2 Type the license key in the fields in the **Add License** box.
- 3 Click **Apply License**.
The **Licenses in system** list is updated.
- 4 Close the **License Manager** window.

You must restart the system before you can use the option.

NOTE: A license key is valid for only one system and one option. You must have a different key for each option and for each system.

NOTE: You cannot edit the Scanner identification number. It is a unique number generated by the system.

Importing and Exporting System Configurations

You can export or import a Pro Package to or from an external storage device. When you do this, the bodymarks, labels, user-defined key assignments, Doppler/M-mode monitor layout, measurement groups, and **Patient** window setup that are associated with the Pro Package are exported or imported. A fetal weight curve may also be included, if appropriate.

You can also import or export system settings that go with the Pro Package. These include 3D presets, DICOM settings, video settings and format, and general settings. (General settings are language and location information, date and time format, and video format.)

To open the Export/Import window:

- Click the **Export/Import** tab.

The **Pro Packages** tab in the **Export/Import** window opens with a list of Pro Packages. Use this tab to import or export Pro Packages. Click the **System Settings** tab to import or export system settings, including 3D presets.

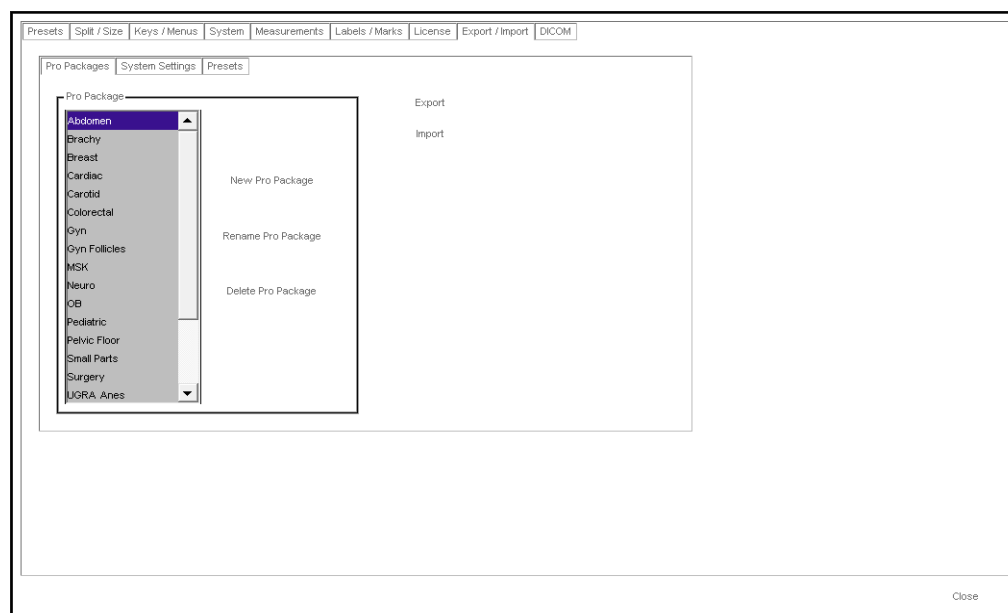

Figure C-26. The Export/Import window opened to the Pro Packages.

To export a Pro Package or system setting:

- 1 From the list on the left, select the item you want to export.
- 2 Click **Export**.

When you point to **Export**, a triangle appears to the right of it. Click the triangle to choose whether you want to export to a CD/DVD or a USB storage device.

NOTE: *If you export to a USB storage device, make sure that it is not set to be write-protected.*

NOTE: *When you export to a CD/DVD, the files are actually exported (copied) to the staging area and are not burned until you click **Burn CD...** If other files have been copied to the staging area, they will be burned to the same CD/DVD unless you delete them. If the staging area contains files waiting to be archived to CD/DVD, you will not be allowed to export to a CD/DVD until you have burned the archive CD/DVD.*

- 3 Type in a file name when you are prompted.

4 Press **Enter**.

NOTE: See “Using CD/DVDs” on page 58 and “Using USB Storage Devices” on page 60.

To import a Pro Package or system setting:

- 1** Insert a CD/DVD or USB storage device containing the Pro Packages or system settings you want to import.
- 2** Click **Import**.
A list of files appears.
- 3** Click the ones you want to import.

In this window, you can also create a new Pro Package (and then add labels and presets to it, for example). You can also rename or delete a Pro Package by selecting the one you want to rename or delete and then clicking **Rename Pro Package** or **Delete Pro Package**.

Under System Settings, you can export or import

- 3D presets
- Bodymarks
- DICOM (if licensed)
- General Settings
- Gui Control Assignments
- Labels
- Video

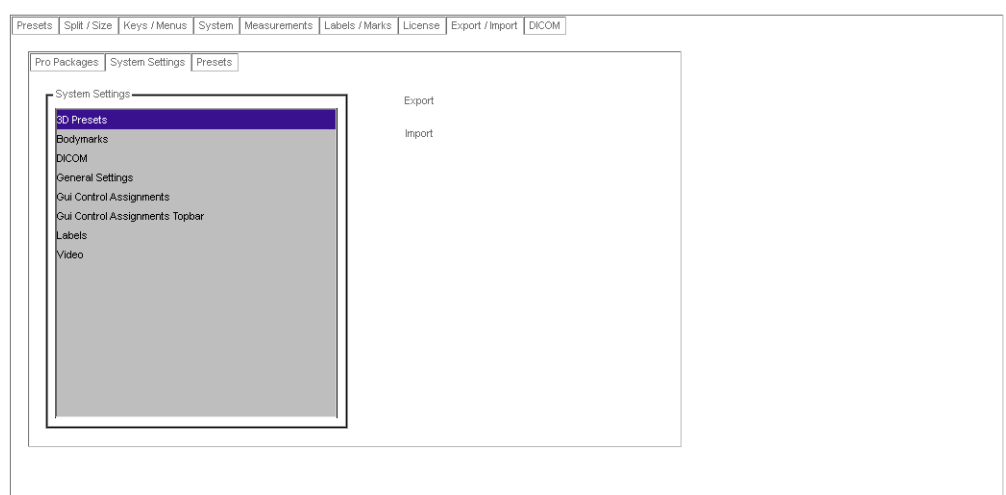

Figure C-27. The Export/Import window opened to the System Settings.

Importing or Exporting Presets

You can export presets to a USB storage device or CD/DVD and then import them to another bk3000 or bk5000 system. You can also export customized setups before an upgrade as a backup.

After a software upgrade, you must import presets you have created or modified back into the system.

To export a preset:

- 1 In the **Export/Import** window (Fig C-26), click the **presets** tab.
The **preset Export/Import** window opens.

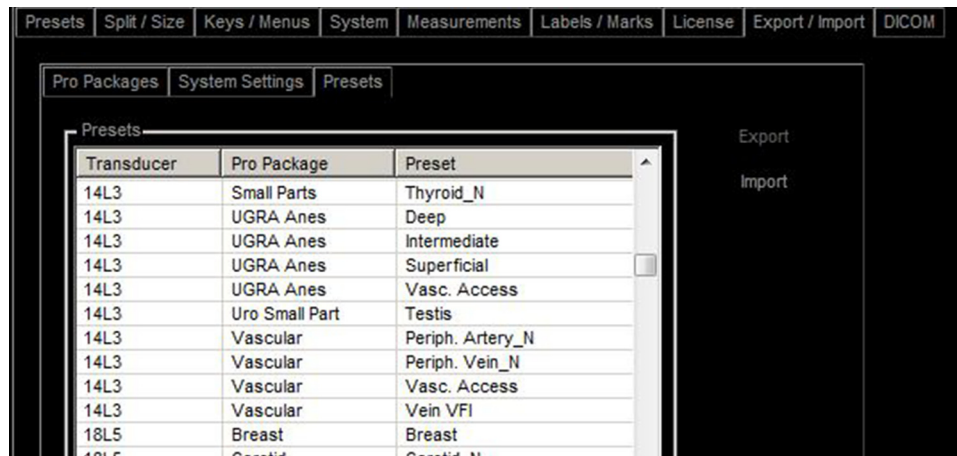

Figure C-28. The Preset Export/Import window.

- 2 Select the presets that you want to export, and click **Export**.

When you point to **Export**, a triangle appears to the right of it. Click the triangle to choose whether you want to export to a CD/DVD or a USB storage device.

NOTE: If you export to a USB storage device, make sure that it is not set to be write-protected.

NOTE: When you export to a CD/DVD, the files are actually exported (copied) to the staging area and are not burned until you click **Burn CD ...** If other files have been copied to the staging area, they will be burned to the same CD/DVD unless you delete them. If the staging area contains files waiting to be archived to CD/DVD, you will not be allowed to export to a CD/DVD until you have burned the archive CD/DVD.

You are prompted for a file name to which the presets will be saved.

The selected presets are saved, with their existing names, as part of the named file.

To import a preset:

- 1 In the **Preset Export/Import** window (Fig C-28), click **Import**.
The **Files List** window appears.

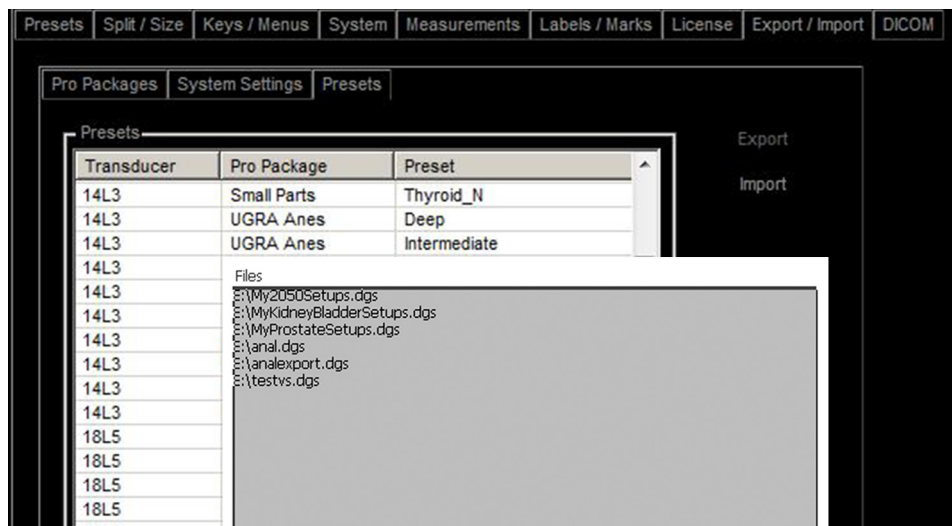

Figure C-29. The Files List window.

The Files List lists all preset files (filename.dgs) or Pro Packages (filename.pac) that are on external devices connected to the system, for example, on a CD/DVD or USB storage device.

NOTE: A .dgs file may contain more than one preset. A .pac file can contain only one Pro Package, but that Pro Package may contain many presets.

- 2 Select the file you want to import from and click **OK**. You can select only one file at a time.

The **Import Presets** window appears.

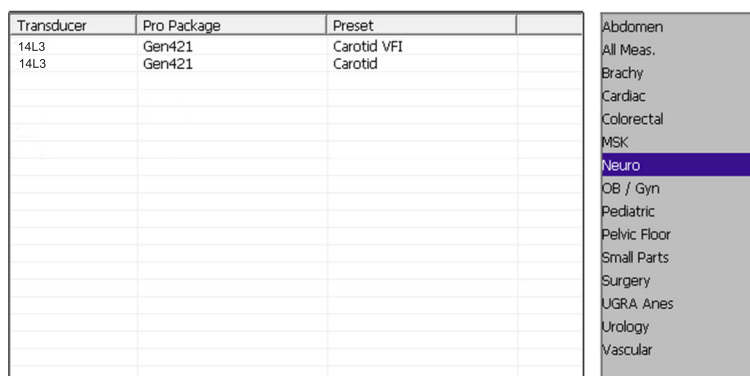

Figure C-30. The Import Presets window.

This window lists all the presets in the selected file. For each preset, you can see the transducer and Pro Package it is associated with (if it was exported as part of a Pro Package).

- 3 In the left-hand list, select the presets you want to import.
- 4 In the right-hand list, select the Pro Package you want to import them to, or click **New Pro Package** to create a new one to contain the imported setups.
- 5 If you are creating a new Pro Package, type in a file name when you are prompted.
- 6 Click **Import**.

If the listed Pro Package exists on the system, the preset is imported into it.

NOTE: *If the name of an imported preset is the same as one that already exists in the Pro Package, you will end up with 2 presets with identical names.*

To prevent this from happening, create a special (temporary) Pro Package (called My Imports, for example) and import the setups to that. Then rename the imported setup before you copy it to the “correct” Pro Package.

DICOM Setup

DICOM is not installed on the bk3000 or bk5000 as a default. You must purchase a DICOM license from BK Medical before a qualified service technician can install DICOM on your system. The *bk3000 Service Manual* and *bk5000 Service Manual* contain instructions for service personnel to use when setting up your DICOM system.

If DICOM is enabled on your system, various DICOM setup windows can be accessed by clicking the **DICOM** tab.

NOTE: *Changing the DICOM setup can cause your system not to work properly. For example, you may be unable to print to a DICOM printer. All changes to the DICOM setup should be made by qualified service personnel only.*

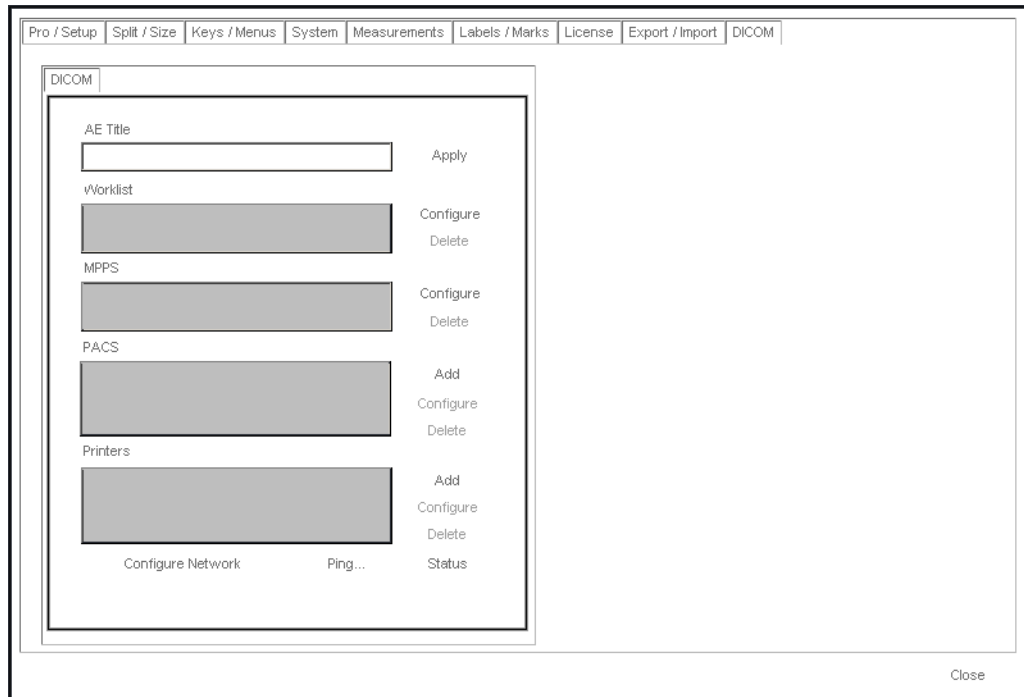

Figure C-31. The DICOM setup window.

Appendix D

Redefining Screen Keys – Label, Bodymark, and Measurement

You can take a label, bodymark, or measurement screen key and redefine it to be another key of the same type.

To redefine a label, bodymark, or measurement screen key:

1 Open the **Measure and Mark** tab.

2 Click **Advanced**.

A small circle appears in the upper right corner of all Label, Bodymark and Measurement screen keys.

3 Click the circle.

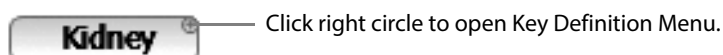

Figure D-1. Circle to open Key Definition menu.

The **Key Definition** menu opens, with the current key name at the top.

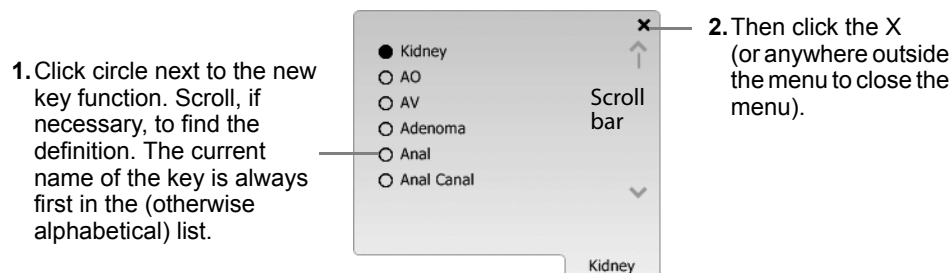

Figure D-2. Key Definition Menu.

4 Scroll down the list to find the new definition you want.

(The list is alphabetical. Type a letter to scroll to the first definition that begins with that letter.)

5 Click the circle next to it.

6 Close the menu by clicking the X in the upper right corner or clicking anywhere outside the menu.

NOTE: A B-mode measurement can only be changed to another B-mode measurement, and a D-mode measurement can only be changed to another D-mode measurement.

Other Settings

Custom Label

If you don't find the label (word) you want to assign to a label key, you can make a new label.

To define a new label key:

- 1 In the **Key Definition** window, click **Settings**.

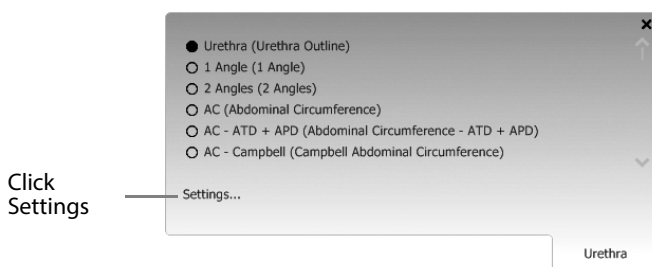

Figure D-3. Key Definition Window.

- 2 A new menu appears off to the side of the window.
- 3 Click **Add New Label**.
- 4 Type the new label in the dialog that appears.

Default Position

To set a new default position for a label:

- 1 Select the label. (It turns blue.)
- 2 Position it on the monitor in what you want to be the default position.
- 3 Click the right circle on the key to open the **Key Definition** window. (See Fig D-1.)
- 4 Click **Settings**, then **Set as default position**.

Results or Calculation Methods for Measurements

Some measurement keys have some additional features or setting possibilities. Here is an example:

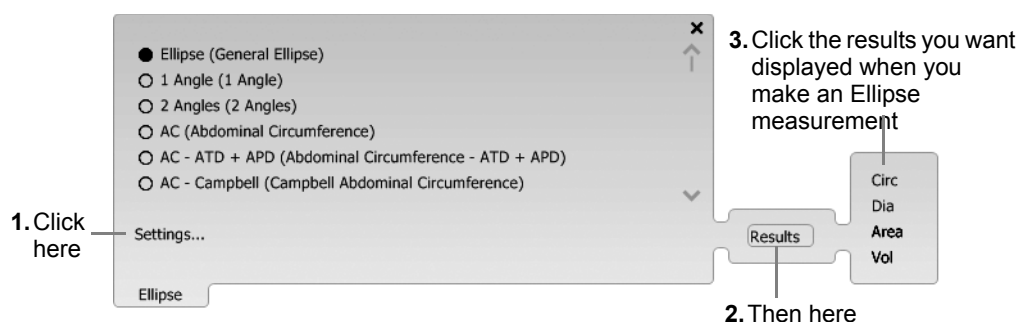

With some OB measurements (BPD, for example), you can also select the calculation method to be used.

Restricting the Menu in “More” Keys

Only a few of the possible labels and measurements have screen keys assigned to them. To use other labels or measurements, you can click **More Meas.**, **More Bodymarks** or **More Labels** and select from a list. By default, all options are shown. You can restrict the options so the list is more manageable.

To specify the list that will appear when one of the “More” keys is clicked:

- 1 Open the **Measure and Mark** tab.
- 2 Click **Advanced**.
- 3 Click the drop-down arrow on e.g. the **More Bodymarks** key.
- 4 Click the circle next to each item that you want to have appear in the list when the key is clicked (“pressed”). If no circles are selected, all menu items will appear in the list.
- 5 Close the **Key Definition** menu.
- 6 Click **Advanced** to turn it off.

You are prompted to save your changes.

NOTE: *Be sure to turn off **Advanced** after you make changes because otherwise they will not be saved.*

Appendix E

Configuring the bk3000 and bk5000

Before You Begin

NOTE: Configuration requires familiarity with the system. Default settings are designed to help you easily use the system after your basic training. More experienced users may want more configuration. Configuration Mode was designed to help those users. If you have any questions about Configuration Mode, contact your BK service representative.

Configuration Mode

Using the Configuration Mode, you can configure on-screen information, keys, input fields, etc., for your bk3000 or bk5000 system.

To enter (or leave) Configuration mode:

- Press **Ctrl+Alt+C** (or **Fn+C**).

All possible keys for the tab are displayed (such as when you click **Advanced**).

Notice how each key has a small, open circle in its top left corner; this is explained in the next section.

The symmetrical rows and columns of small circles – called Configuration circles – form the grid.

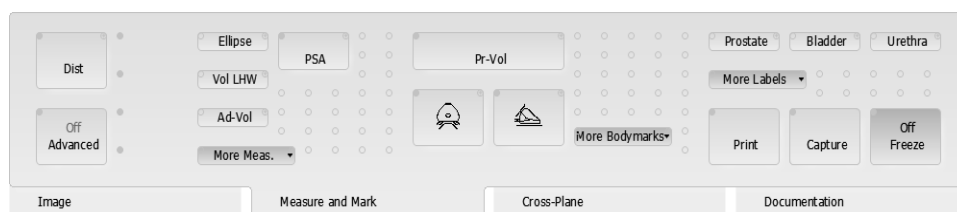

Figure E-1. Grid and key-editing circles visible in Configuration Mode.

Key Definitions (Redefining an Existing Key)

To redefine an existing key:

- 1 On the key, click the small circle in the top left corner (see Fig E-1.)
- 2 A menu appears for editing the key (as shown with the ETD key sample in Fig E-2.)

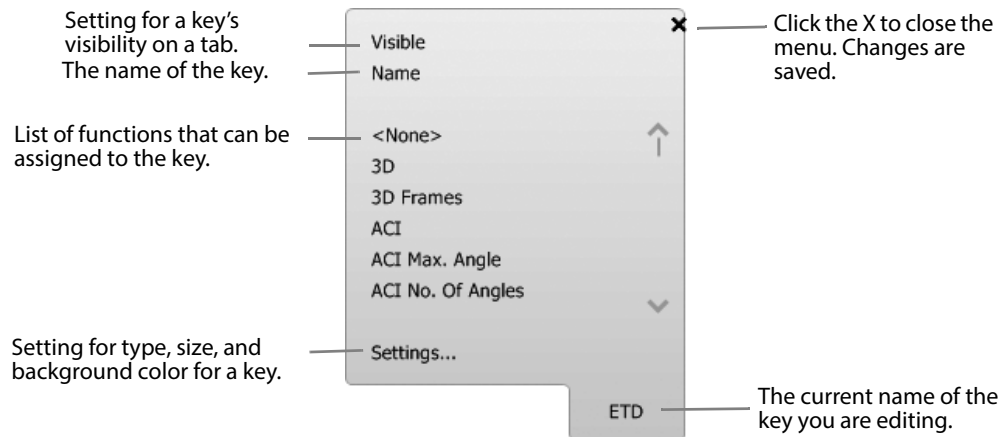

Figure E-2. Sample menu for redefining an existing key.

The following table explains how to edit the definitions for a key.

Menu Item	Purpose, and How to Change
Visible	When highlighted, the key is visible. Click to turn visibility on or off.
Name	To change the name of the key, click Name and the current name is shown on a submenu. Click the current name, and an editing box opens where you can enter a new name.
Function list	Select a function for the key from this list. Selecting <None> (always at the top of the list) deletes a key. Hint: To find a function quickly, type the first letter of the name to hop directly to functions beginning with that letter. Note: The list contains only functions that are available in the current system state and imaging mode. For example, to assign a key to D-scale, you must put the system in D-mode first, making sure that Doppler is activated.
Settings	Click to open a submenu of additional settings to redefine: <ul style="list-style-type: none"> Type – Button or slider. Size – Small, medium, or large font size. When using the large font size, you may need to resize some buttons to allow space for all information. Color – The background color for text. You cannot change the color of the letters, but you can change the background color for easy identification in a workflow or for better readability.

Table E-1. How to edit a key's attributes.

You can always find out what a renamed key does by opening its menu in Configuration mode and scrolling through the names. The function that is assigned to the key is highlighted.

When you are in Configuration mode, you can identify the keys that are visible in Basic mode – they have a filled circle in top left corner (as shown in Fig E-3.)



Figure E-3. Example of keys with filled circles indicating visibility in Basic mode.

Use the grid to determine the size of a key. In Fig E-4, the key is 3x1 – 3 columns by 1 row.



Figure E-4. A key that is 3x1 in size.

Unavailable Spaces

If you see an area where the Configuration circles are missing from the grid, a key is already defined for that area but is not available in the present situation.

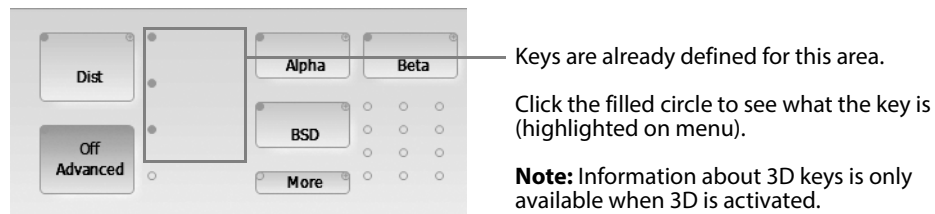

Figure E-5. Area with no Configuration circles is already in use.

Not all functions are available on all tabs. For example, most documentation functions are only available on the Documentation tab.

The Imaging Tabs

The **Imaging** tab has several mode subtabs that can also be made Visible or Invisible. Click the circle and click **Visible**.

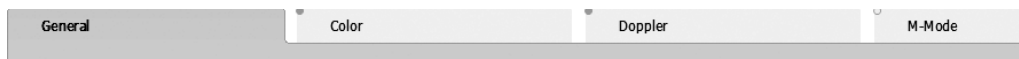

Figure E-6. The mode subtabs on the Imaging tab.

Some factory defaults affect tab visibility. For example, by default, the M-mode tab is only visible in the OB and Cardiac Pro Packages.

A tab cannot appear only in Advanced mode. It must be *visible* to appear at all.

The fields on the **Imaging** tabs are divided into two sections. The lower section is common to all mode tabs and appears regardless of what mode tab is in the upper section.

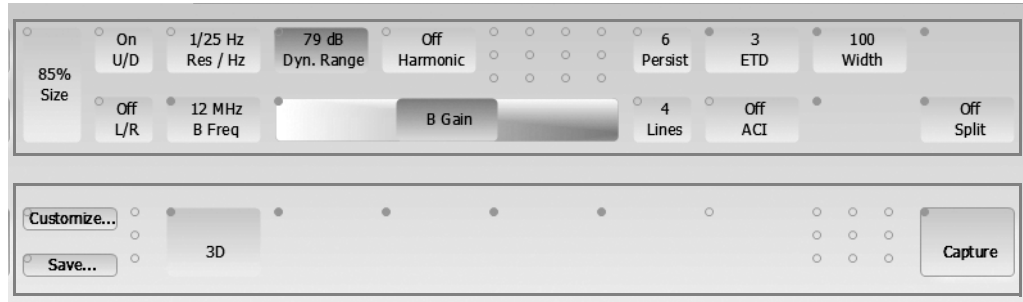

Figure E-7. The two sections of the Imaging tab.

Special 3D Mode Tab

When a 3D data set is acquired (or reviewed), a special 3D mode tab appears.

Two versions are available:

- A tab containing the most frequently used 3D review controls.
- A tab that is divided into two 3D subtabs, which together contain all 3D review controls.

In Configuration mode, you specify which version is displayed (by making it Visible).

Measure and Mark Tabs

Two versions of the **Measure and Mark** tabs are available in Configuration mode (see Fig E-1). As with the **3D Mode** tab, one version of the **Measure and Mark** tabs is divided into subtabs and the other version is not.

The subtab version is used when the number of measurement, label, and bodymark keys cannot all fit on one tab.

To specify the number of subtabs and make them Visible, click the circle on the tabs and use the menu that appears.

Click **Name** on this roll-up menu to give the subtab a name.

NOTE: *The leftmost tab can never be made invisible or renamed.*

Documentation Tab

When you are reviewing a clip or image, clicking **Report**, or connecting a USB device, an extra menu appears above the **Documentation** tab as shown (and circled) in Fig E-8.

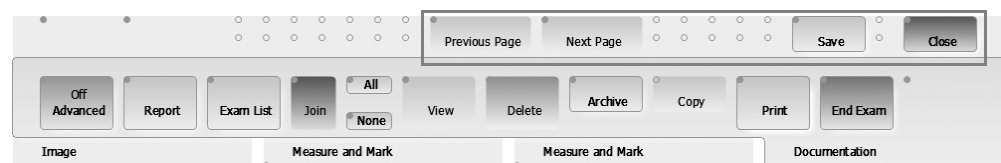

Figure E-8. The extra Documentation tab menu.

Set up keys for this extra menu by referring to “Key Definitions (Redefining an Existing Key)” on page 293.

Patient Dialog

Open the Patient dialog to make your configurations. As shown in Fig E-9, you can:

- Define what columns are displayed.
- Insert and delete input fields.
- Show or hide keys.

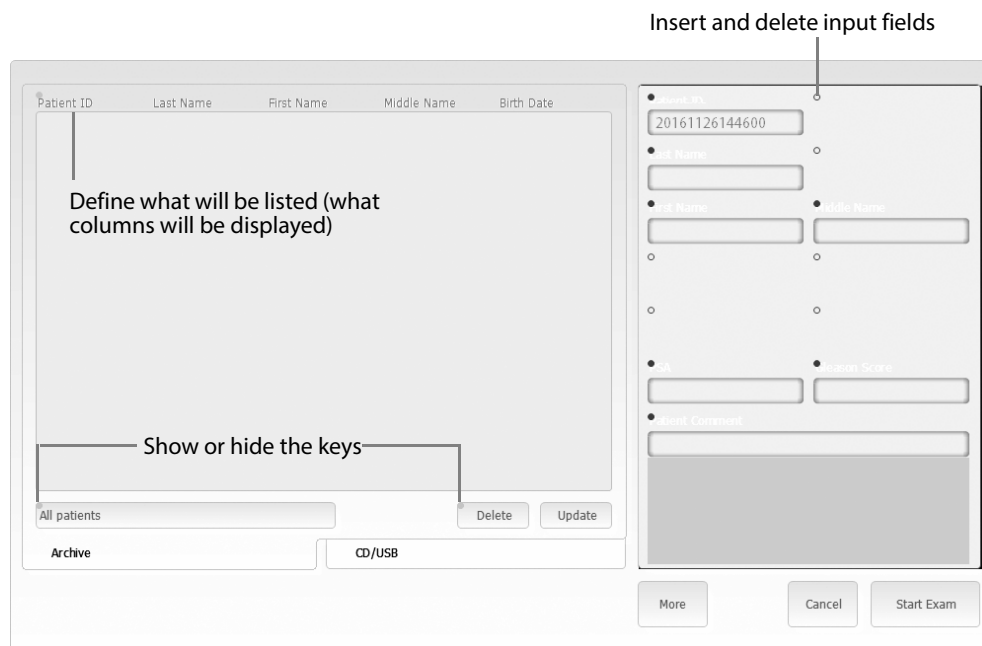

Figure E-9. The patient dialog in Configuration Mode.

Display Areas and Info Boxes

NOTE: To edit info boxes, Freeze must be off.

Display areas are the parts of the monitor outside the image. Within the display area, measurement results and settings are shown in info boxes.

You can view and work with the display areas of the monitor when in Configuration mode; the display areas are outlined by dotted lines. See Fig E-10.

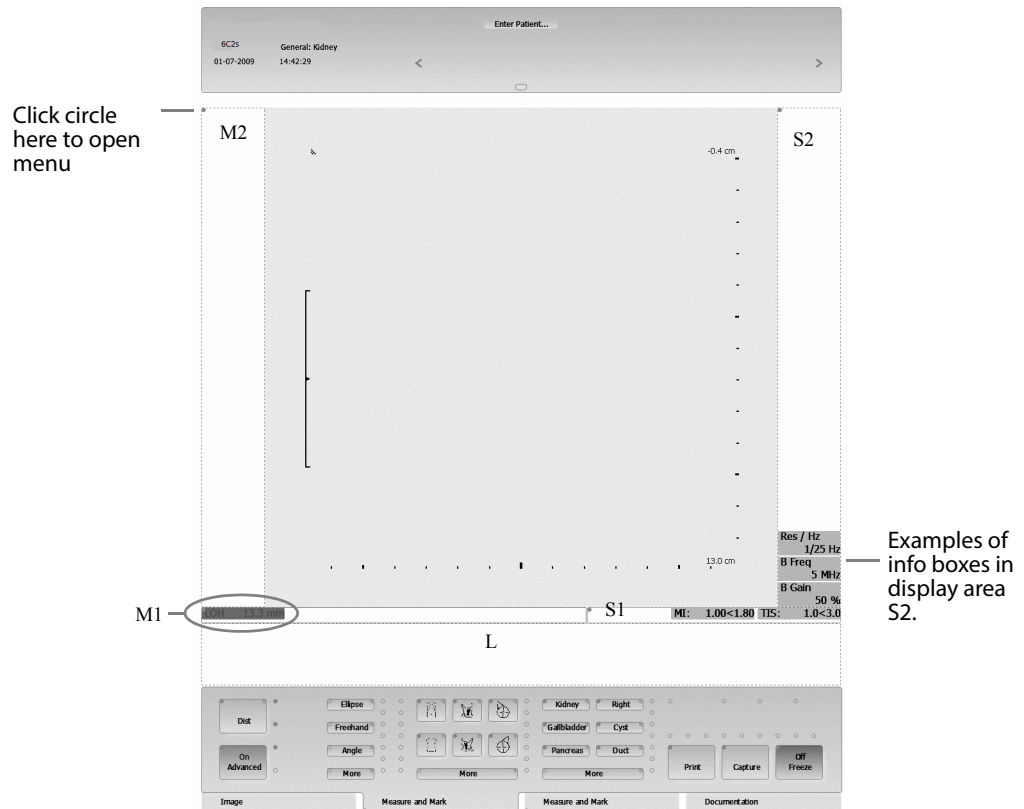

Figure E-10. The display areas of the monitor: M1, M2, L, S1, and S2.

- Measurements are displayed in M1, M2, or L.
- Settings are displayed in S1 or S2.

Each area, except L, has a little circle in the top left corner. Clicking the circle opens the display area's editing menu, which you can use to define what measurements or results will be shown there.

L is used as a default display field – it has no circle, and you cannot edit what is displayed there.

To edit the display area details:

- 1 Click the circle in a display area to open its editing menu.
- 2 Select the measurement results or settings that you want to display there (click the circle, not the name). You can only select measurements or settings available for the system's current mode (B, C, D, M, 3D).
- 3 Click **Size** in the menu to select the font size (small, medium, large) used in the information field.

NOTE: The size choice for one field will apply to all display fields and the Patient Name and ID.

- 4 Turn background color on or off.

You can change a setting (gain, frequency, etc.) in an info box by pointing at it and pressing the +/- key. Therefore, if there is a setting you want to be able to set regardless which tab is displayed – or if you don't have the tabs shown at all – you can make it available by having it displayed in an info box.

Prioritizing the Display of Measurements and Settings

When editing the details of a display area, you are deciding the placement of the info boxes containing measurements and settings. This requires planning: some info boxes contain one line of information and others contain multiple lines of information.

Display priority means that results that do not fit into an intended area are moved to the next area in priority.

- The default display priority for measurements is M1, then L, and then M2.
- The default display priority for settings is S1, then S2.

For example, area M1 can only display one line of information so results requiring multiple lines are moved to area L. However, information in L cannot be seen when the Image tab is displayed (which it usually is during imaging); the results won't be visible. Therefore, if you had set M1 to contain the info box for a BPD measurement with 3 results (BPD, GA, and EDC), the results would be moved to L and you would see nothing. This BPD measurement is more suitable for area M2, an area that can contain multiline info boxes.

Keeping related information grouped together on the monitor can be useful. Therefore, when you plan to display several settings and measurements for an image, put them all in either M2 or S2 because M1 and S2 can only handle one line of information.

Creating a New Pro Package in Configuration Mode

You can create a new Pro Package with keys, tabs, input fields, and display area to suit your specific needs.

To create a new Pro Package:

- 1 On the **Image** tab, click **Customize...**
- 2 On the **Export/Import** tab, click **New Pro Package**.

You are prompted for a new name (a short name and a long name). Then, you select an existing Pro Package to use as a template for your new Pro Package.

Your new Pro Package will be a copy of the one you selected, but with a different name. Everything from the copied Pro Package is available – supported transducers, presets, reports, customized hard key definitions, and so on.

Perhaps there is a Pro Package you like, but you want a new set of tabs and softkeys. You can copy tabs and softkeys from one Pro Package to another using a memory stick.

To copy tabs and softkeys (GUI controls) from one Pro Package to another:

- 1 Insert the memory stick in the system.
- 2 Click **Customize...**, select the **Import/Export** tab.
- 3 Select the Pro Package.
- 4 Click the **System Settings** tab.
- 5 Select **GUI Control Assignments**.

- 6** Click **Export**.
- 7** Remove the memory stick properly, and then insert it in the system where you want to use the GUI controls (the second system).
- 8** On the second system, open the Pro Package you want to import the GUI controls to.
- 9** Go to the **Import/Export** tab on the second system and click the **System Settings** tab.
- 10** Select **GUI Control Assignments** and click **Import**.

NOTE: *The controls will be imported into whatever Pro Package is open on the second system.*

Index

Numerics

2D images, saving 52

3D

4-Up view 213

6-Up view 214

accuracy 211

acquisition, stopping 204

aligning or deleting a face 207

animating the volume 207

annotations 207

arrow 208

Brightness 205

Contrast 205

controlling transducer movement 200

Filter (Render setting) 211, 213

Hue 205

image capture settings 203

imaging direction explained 204

imaging direction with untracked freehand 203

imaging modes possible with 199

imaging overview 201

introduction 199

label 207

Layout options 205

license 199

measurement warning 201

measurements 209

moving the volume 206

Opacity (Render setting) 211, 213

Options (New, Close, Save) 214

Orientation 205

password protection 199

Photorealistic (Render setting) 211, 213

Preset options 205

Presets 205

real-time display 255

Render Settings (Render view) 211

Render view 211

ROI 203

ROI markers 203

rotating the volume 206

setting imaging direction 203

setting up 255

slicing the cube 206

Span (animation) 207

Speed (animation) 207

stopping an acquisition 204

Thickness (Render setting) 211, 213

tilting a plane 206

untracked freehand 200

user views 208

volume measurement 210

warning about measurements 201, 211

ways to view a data set 208

Wire Frame 205

Zoom 205

3D data sets, saving 52

3D Setup window 255

3D Tabs 18

4-Up view (3D) 213

6-Up view (3D) 214

A

Acc (measurement) 225

Acc T (measurement) 225

accents

typing 20

ACI 219

ALARA principle 219

aliasing, CW Doppler

moving baseline to overcome 109

aliasing, Doppler

definition 219

moving baseline to overcome 219

ALSs (measurement) 225

angle correction line, drawing of 100

Angular Compound Imaging. See ACI.

AOD (measurement) 226

Archive (on document browser toolbar) 54

Archive window

opening 61

selecting (filtering) patients in 63

sorting and rearranging columns 63

archive window

filter patients displayed 62

archived documents

viewing 53

archiving

clearing space on hard disk 67

description of system 53

documents (and patient database) 57

managing documents in the system 61

password protection 53

to a CD 57, 58

to a network drive 58

to a PACS 67, 216

to CD, wait to delete from hard disk 67

array transducer 219

audio volume 107

Auto (Cardiac measurement) 219

automatic curve tracing 118

CW Doppler 107

Doppler mode 101

automatic measurement, TAM and TAMX 115

Automatic Planimetry 121, 162, 173, 186, 198

automatic planimetry

with the ellipse function 121

avi format for copied video clips 56

B

- B/A (measurement) 219, 226
- baseline
 - CW Doppler mode 109
- battery
 - critical low 262
 - low 262
 - maximum life 262
 - maximum operation time 262
- battery support
 - setup 261
- biopsy. See puncture.
- B-mode
 - adjusting focus position 73
 - depth 76
 - focus 99
 - gain 83
 - TGC 73
 - zoom 74
- bmp format for copied images 56
- bodymark
 - definition 32, 219
 - deleting from image 33
 - miscellaneous setup 281
 - more options 134
 - on archived images and clip frames 31
 - placing on an image 32, 134, 168, 180, 192
- Bodymark Setup window 274
- BPD (measurement)
 - for calculating GA, FW and EDC 125
- brachy matrix
 - changing the offset 275
 - defining new 276
 - editing user-defined 276
 - highlighting dot on 122
 - in brachytherapy 122
 - options for user-defined 276
 - removing 123
 - selecting 123
 - setting up 275
 - superimposing 122
 - user-defined 124
- Brachy Matrix Setup window 275
- brachy ruler
 - displaying vertical 0 line 275, 279
 - moving 123
 - picture 123
 - setting up 275
 - user-defined 124
- brachytherapy 122
 - entering parameters in Patient window 120
 - verify that guide number is correct on monitor 122
- brightness of key labels 249
- brightness of monitor, adjusting. See Getting Started.book
- Bubble Burst 83
- Burn CD window 59

C

- C (on monitor, next to frequency) 81
- Capture while not scanning (setup) 254
- capturing clips 52
- capturing images 51, 137, 138
- cardiac imaging
 - bodymarks 151
 - capturing clips 158
 - capturing frozen images 157
 - Cardiac Pro Package 147–162
 - cine review 157
 - creating a custom key for M-mode 159
 - FATE 160–161
 - FATE measurements 160
 - labels 150
 - measurements and calculations 151–155
 - presets 147
 - printing from thumbnail images 158
 - printing images on the monitor 158
 - reports 157
- Cardiac Output 156
- carotid velocities 118
- catalog, definition 219
- CD
 - archiving to 57, 58
 - restrictions about archiving and copying to 58
 - setting size (storage capacity) 252
 - staging area 58
 - viewing documents stored on 55
- CHI. See contrast imaging.
- child curve 270
- cine
 - about 33
 - activate on freeze 254
 - definition 219
 - effect of changing some parameters 33
 - frame numbers 34
 - image storage 33
 - in M-mode and D-mode 34
 - measurement markers 35
 - measurements 34
 - options 254
 - restore factory defaults 254
 - turning on and off 33
 - viewing image 55
- clearing
 - patient archive 64
- clearing patient archive 264
- clip capture
 - backward 52
 - forward 52
 - while not imaging 52
- Clip Storage and Cine Setup window 253
- clips
 - always export codec with 254
 - capture while not scanning 254
 - clear buffer on freeze 254
 - clear buffer on start timer 254

- clear buffer on unfreeze (setup) 254
 - clip storage options 254
 - enable storage 254
 - export clip storage codec 254
 - frame rate 254
 - length 254
 - restore factory defaults 254
 - codec
 - export 254
 - exporting (setup) 254
 - installing on your PC 56
 - color bar
 - invert to match inverted spectrum 264
 - color box
 - color mode 87
 - definition 219
 - locking to Doppler gate 273
 - Color Map for VFI (illustration) 93
 - color mode
 - about 86
 - color box 87
 - definition 220
 - range 25
 - Color Square indicator for VFI 93
 - combination mode 77, 220
 - composite focus. See multiple focus.
 - Configuration Mode
 - entering 293
 - Configuration mode
 - Configuration circles 293
 - copying tabs and softkeys between Pro Packages 299
 - creating a new Pro Package 299
 - extra menu on Documentation tab 296
 - Measure and Mark tabs 296
 - measure and mark tabs 296
 - Patient dialog 297
 - prioritizing display areas for measurements and settings 299
 - redefining existing key definitions 293
 - special 3D mode tab 296
 - subtabs for Imaging tab 295
 - Continue Current Exam 62
 - contrast imaging
 - description 79
 - displayed frequencies 81
 - turning on 81
 - using 82
 - Copy (in Curve Setup window) 272
 - Copy (on document browser toolbar) 54
 - copying documents
 - format 54, 56
 - how to do it 57
 - selecting format 57
 - without patient ID 57
 - cube (3D)
 - rotating 206
 - slicing 206
 - curve
 - child 270
 - creating a new 272
 - editing an existing 272
 - parent 270
 - type 271
 - Curve Setup window
 - information fields in 271
 - options in 272
 - picture 270
 - purpose 269
 - CW Doppler indicator
 - on B-mode image 105
 - CW Doppler line
 - about 106
 - picture 106
 - CW Doppler mode 108
 - aliasing 109
 - audio volume 107
 - automatic curve tracing 107
 - baseline 109
 - Doppler trace 107
 - gain 107
 - invert 108
 - MI 105
 - sweep speed 109
 - switching between live B-mode and 105
 - TI 105
 - turning off 106
 - turning on 105
 - unfreezing spectrum 105
 - wall filter 108
- ## D
- database, password protection of 66
 - date and time
 - changing 252
 - changing format 252
 - frozen with image 29, 221
 - dcn file 215
 - Dec T (measurement) 220, 228
 - default settings, restoring 252
 - DEFINITY 79
 - Delete (in Curve Setup window) 272
 - Delete (on document browser toolbar) 54
 - deleting
 - documents 64
 - patient archive 64, 264
 - patient records 64
 - depth
 - measuring 40
 - Depth, customizing control 250
 - dgs file 286
 - DICOM
 - changing setup 287
 - filenames 215
 - format for archived images and clips 56
 - format for copied images 56
 - format for copied video clips 56
 - saving or printing to 215

- setting up 287
 - structured reports 216
- DICOM status indicator 216
- DICOM viewer 56
- directions 204
- Discontinue Examination 217
- distance, measuring 40
- document
 - caution about deleting 60
 - printing 69
 - saving 51
 - selecting or deselecting in document browser 53
 - types 51
 - viewing externally stored on system 55
- document browser
 - and Archive window 61
 - and archiving system 53
 - description 53
 - externally stored documents 53
 - externally stored documents and 55
 - images in 138, 157, 170, 182, 195
 - manipulating thumbnails 53
- document browser tools 54
- documents
 - copying to a CD or USB storage device 57
 - deleting 64
 - viewing externally stored 55
- Doppler
 - keep same state when steering changes 264
- Doppler curves, changing color 273
- Doppler gate
 - moving 101
 - picture 100
 - resizing 101
- Doppler indicator
 - on B-mode image 100
 - picture 100
- Doppler line, picture 100
- Doppler measurements
 - choosing units for 273
- Doppler mode
 - aliasing 219
 - automatic curve tracing 101
 - changing monitor layout 247
 - definition 221
 - Doppler trace 101
 - HPRF 101
 - sample volume 100
 - sweep speed 101
 - turning off 100
 - turning on 100
- Doppler real-time calculations, changing whether displayed 273
- Doppler spectrum
 - description 113, 124
- Doppler trace 116
 - CW Doppler mode 107
 - Doppler mode 101
- duplex (definition) 221

duplex. See combination mode.

E

- ED
 - correct placement of marker 113
 - in A/B (Stuart Index) 116
 - in A/B ratio 116
 - in A/B, definition 219, 225
 - in B/A, definition 219, 226
 - in formula for resistance index 116
 - in RI 116
 - measuring PI automatically 117
 - measuring PI manually 117
 - measuring RI 117
 - placing marker to measure RI 116
 - real-time measurements 117
- EDC (measurement) 221
- editing video clips 55
- Elastography 88
 - about 88
 - color box 89
 - color map 90
 - Diameter Comparison Measurement 91
 - quality indicator 90
 - Strain Ratio Measurement 90
- EMC (definition) 221
- emergency state
 - using system without a password 66
- Enable (clip storage) 254
- ES
 - correct placement of marker 113
- ESD
 - definition 221
- ET (definition) 228
- ET AV (measurement) 228
- ET MV (measurement) 228
- ET PV (measurement) 228
- ET TV (measurement) 228
- ETD (definition) 221
- exam
 - discontinue current 62
 - edit current patient 62
 - pause and resume 65
 - save patient details for all exams 62
 - start new without clearing image 62
 - starting 65
- Examination List 62
 - filtering 63
 - hiding 64
 - sorting 63
- Examination Type 16
- Export (in Curve Setup window) 272
- Export Codec (setup) 254
- Export/Import window 283, 284
- exporting
 - log file 258, 259
 - preset 285
 - Pro Package or system setting 283

F

- F1, F2 (measurement) 221
- factory setup, restoring 252
- FATE (cardiac imaging) 160–161
- FATE measurements 160
- FFT spectrum. See Doppler spectrum.
- FFT, definition 221
- filename
 - set prefix for exported files 264
- Files List window 285, 286
- Filter (3D Render setting) 211, 213
- focus
 - B-mode 99
- Focus indicator (picture) 72
- focus position, adjusting (B-mode) 73
- FOI (field of interest) 221
- follicle diameter measurements 125
- format
 - archived documents 56
 - copied documents 56
 - DICOM 56
 - exported documents 56
- Forward Capture 52, 254
- freeze, partial 29
- freezing the image 29
- frequencies (displayed), contrast imaging 81
- FW
 - measurement 229
 - measuring tools 125
- FW/GA reference curve, specifying 273

G

- GA
 - and reference data 124
 - calculating from ultrasound or clinical parameters 124
 - definition 229
 - measuring tools 125
 - usually expressed in days 125
- gain
 - B-mode 83
 - CW Doppler mode 107
 - setting to be displayed in db 264
- General Setup window 250, 251
- gestational age
 - by ultrasound 124
 - clinical 124
- Gleason score 120
- gray scale
 - hiding 273

H

- H (on monitor, next to frequency) 79
- hard disk
 - clearing space on 67
 - free space 61, 62, 258
 - patient archiving quota 67
- hardware versions 258

- Heart Rate (1-10) (measurement) 230
- HIPAA
 - about 51
 - compliance 51
 - definition 221
 - password protection of database on system 66
- HPRF 101
- HR, real-time measurement 117
- HWL
 - factor, changing 273

I

- IEC (definition) 221
- image
 - format of copied 56
 - freezing and unfreezing 29
- image orientation, adjusting 21
- image review. See cine.
- images
 - format 56
- imaging 32, 134, 151, 168, 180, 192
- imaging direction
 - setting in 3D 203
 - untracked freehand 3D and 203
- imaging plane
 - indicator 32, 33, 134, 151, 168, 180, 192
 - selecting 29
- imaging plane indicator, setting step size per click 281
- Import (in Curve Setup window) 272
- Import Presets window 286
- importing
 - preset 285
 - Pro Package or system setting 284
- invert
 - CW Doppler mode 108
- IOP (definition) 221
- IVF (definition) 221

J

- joining video clips 54

K

- Key Assignment Setup window 248, 249
- Keyboard 20

L

- label
 - change orientation word 32
 - definition 222
 - editing on the image 32
 - miscellaneous setup 281
 - moving 32
 - on archived images and clip frames 31
- Label Setup window 274
- lagarith version required 56
- language, changing 251
- Last Mens. Date 124
- LC (measurement) 222
- letters

- typing special letters or accents 20
- license key 282
- License Manager window 282
- licenses
 - about 282
 - installing 282
- Linked Split/Dual 31
- LMP 124, 222
- log file, exporting 258, 259
- login to system 66
- login window 66
- Long 222
- LVOT diameter s (measurement) 235

M

- M/Doppler Gain (key) 82
- manual measurement, TAM and TAMX 115
- MD (minimum diastole)
 - correct placement of marker 113
 - in pulsatility index 116
 - measuring PI manually 117
 - real-time measurement 117
- mean trace curve
 - automatic 115
 - changing color 273
- Measure and Mark Tab 18
- measurement cursors, size 273
- Measurement Definition Setup window
 - opening 265
 - options in 266
 - purpose 264
- Measurement Definition Wizard 266
- measurements
 - clearing 40
 - clearing all 40
 - creating 266
 - defining and editing 266
 - depth 40
 - D-mode 47
 - formula syntax for 268
 - importing and exporting 264
 - making 39
 - on a cine image 34
 - on archived images 39
 - results 40
 - user-defined, types 265
- measurements (3D), warning 201, 211
- Measurements and Image Data 17
- measurements, user-defined 265
- measuring tools
 - angle 41
 - B-mode 40
 - circle 42
 - color mode 40
 - distance 40
 - Doppler 47
 - Doppler outline curve 49
 - ellipse 43
 - freehand drawing 46

- polygon 45
- MI (Mechanical Index)
 - and CHI 81
 - checking setting for contrast imaging 82
 - CW Doppler 105
- MIP (definition) 222
- Miscellaneous Marks Setup window 281
- Miscellaneous Measurement Setup window 272, 273
- M-mode
 - about 102
 - changing monitor layout 247
 - image ruler 103
 - line 103
 - monitor setup (picture) 103
- monitor brightness, adjusting. See Getting Started book.
- monitor user interface 15
- mouse
 - cursor hidden 249
 - speed 249
- MPPS (definition) 222
- multiple clips
 - capturing (screen control) 22
 - setting file length of each clip 254
 - setting total recording length of all clips in a sequence 254
- multiple focus 72

N

- nearfield width 247
- needle guide
 - verify correct number on monitor 122
- NEMA (definition) 222
- Network Drive Setup window 258
- network drive, archiving to 58
- network password 60
- neuro imaging
 - bodymarks 168, 180, 192
 - capturing clips 171, 182, 195
 - cine review 170, 181, 194
 - copying or archiving images and clips 171, 182, 195
 - labels 166, 179, 191
 - Neuro Pro Package 163–173, 187–198
 - printing from thumbnail images 171, 183, 196
 - printing images on the monitor 171, 183, 195
 - saving a new preset 172, 184, 196
- New (in Curve Setup window) 272
- Noise Limit 118
- noise, reducing 24, 118
- NTSC 251
- nuchal translucency measurements 125

O

- OB
 - curves in report 126
 - definition 222
 - report 125
- obstetrics report 125

- office printer
 - setting up 256
- ON/standby button (definition) 224
- Opacity (3D Render setting) 211, 213
- orientation
 - image, changing 21
- orientation of imaging plane 29
- P**
- pac file 286
- PACS
 - archiving to 216
 - cannot use document browser with 53
 - definition 222
 - saving to 57, 216
- PAL 251
- parent curve 270, 271
- partial freeze 29
- password
 - restrictions 257
 - superuser default 257
- password protection
 - enabling and disabling 257
 - patient archive database 66
 - setting up 257
- Password Setup window, about 257
- patient archive
 - clearing 64, 264
 - deleting 64, 264
- Patient Archiving and Communications System. See PACS.
- patient archiving system
 - description 53
 - password protection 53, 66
- patient information
 - editing 62
 - entering 17
 - from DICOM worklist 215
- patient record, deleting 64
- Patient window
 - illustration 62
 - in 3D 202
- pause and resume an examination 65
- PE 222
- PED 222
- perioperative (definition) 222
- perpendicular, making sure measurements are 41
- persistence, about 222
- PFV AV (measurement) 237
- PFV LA (measurement) 237
- PFV MV (measurement) 237
- PFV PV (measurement) 237
- phased array 222
- Photorealistic (3D Render setting) 211, 213
- PHT MV (measurement) 237
- PI
 - definition 222, 237
 - real-time measurement 117
- PiP
 - about 35
 - adjusting the window 37
- plane, imaging. See imaging plane.
- planimetry
 - definition 223
 - description 120
 - formula for automatic 121
 - making a calculation 121
 - starting point for calculation 120
 - step size, setting 273
- POI (point of interest) 98, 99, 223
- Power Doppler 223
- power failure during file transfer to PACS 216
- power mode 86
- Power save mode 261
- power supply cord 223
- preset
 - caution about identical names 287
 - exporting 285
 - importing 285
 - saving 103
- Preset Export/Import window 285
- Prev. Exam. Date 124
- PRF (pulse repetition frequency)
 - and VFI color map (illustration) 93
 - selecting velocity range with 223
 - use Scale to adjust 25
- Print (on document browser toolbar) 54
- printer
 - setting up 255
 - setting up an office printer 256
- Printer Setup window 255, 256
- printing
 - from thumbnail images (without opening) 70
 - images displayed on the monitor 70
 - quality of printed image 69
 - setting default printer 70
 - test page 255
 - thumbnail after opening 70
 - using transducer button 70
- Pro Package
 - accessing other Pro Packages 16
 - creating new 284
 - definition 223
 - deleting 284
 - exporting 283
 - exporting and importing 282
 - importing 284
 - list of 112
 - renaming 284
 - selecting 16
- Pro Package Menu window 82
- Pro Package Setup window 246
- procedure (setup) 265
- programmable puncture guide 123
- PS
 - correct placement of marker 113
 - real-time measurement 117
- PSA 223, 237

PSA factor
 setting 273
PSAD
 definition 223, 237
pulse repetition frequency 223
puncture
 performing 122
 puncture line 122
 warning about changing offset of programmable
 puncture guides or brachy matrixes 166, 177,
 189
 warning to verify puncture guide number 166,
 177, 189
 warning to verify transducer type number 165,
 177, 189
puncture guide
 verify that number is correct on monitor 122
PW Doppler 223

R

range, color mode 25
real-time measurements
 PI 117
 setting up 273
 turning on and off 117
Render Settings (3D Render view) 211
Render view (3D) 211
report
 about 67
 adding images 68
 adding remarks 68
 changing page 68
 creating 68
 displaying 68
 editing 69
 obstetrics 125
 patient comments included 69
 printing 69
 saving 52
 saving to patient archiving system 69
report template 273
resistance index. See RI.
RI (Resistance Index)
 about 116
 formula 116
 real-time measurement 117
right angles, making measurements at 41
Right Ovary Height (measurement) 240
Right Ovary Length (measurement) 240
ROH (measurement) 240
rotation axis
 defining 44
 effect on volume determination 44
RVDd (measurement) 242
RVDs (measurement) 242
RVOT diameter d (measurement) 242
RVOT diameter s (measurement) 242

S

sagittal imaging plane 29
sample volume
 Doppler mode 100
 false 100
 false, moving 101
 false, with HRPF 100, 101
 with angle correction 100
Save (in Curve Setup window) 272
Save Diagnostic Setup window 103
saving
 2D images 52
 3D data sets 52
 Diagnostic Setups 103
 documents 51
 patient details 62
 reports 52
 video clips 52
screen key (definition) 223
 make new 141
Screen Layout Setup window 247
sculpting tools (3D) 211
service manual 287
SI (measurement) 242
simultaneous split-screen imaging 30
software version 258
SonoVue 79
spectrum display, changing smoothness of 108
split screen
 simultaneous 30
 using 30
SS
 correct placement of marker 113
 definition 223
ST Area 242
ST Dist 242
staging area (CD)
 adding files to 58
 browser description and picture 59
 caution about clearing 60
 clearing 60
 deleting documents from 60
 reviewing and deleting documents in 59
 setting size 252
 size 58
 viewing documents in 60
 when full 58
Start new exam without clearing the image 62
steering
 independent D-mode/C-mode 87, 101
 set correction angle 264
 use last correction angle 264
stenosis calculation
 based on area (ellipse) 242
 based on area (freehand) 242
 based on distance 242
step size per click imaging plane indicator, setting 281
stitch line 224

- stored documents, viewing 53
- superuser
 - name and password 257
 - privileges 257
- sweep speed
 - CW Doppler mode 109
- sweep speed, Doppler mode 101
- Sync Steer 101
- Sync Steer (screen key) 87
- syntax for measurement formulas 268
- system
 - logging in 66
 - using without logging in 66
- system settings
 - exporting 283
 - importing 284

T

- TAM
 - definition 115
 - real-time measurement 117
 - ways to measure 115
 - with automatic Doppler curves 115
 - with manual Doppler curves 116
- TAMX
 - definition 115
 - real-time measurement 117
 - ways to measure 115
 - with automatic Doppler curves 115
- TAMX (measurement) 224
- T-area (measurement) 224
- TBL (measurement) 242
- TEH (True Echo Harmonics). See tissue harmonic imaging.
- TEH, definition 224
- test page, printing 255
- TGC
 - adjusting 74, 130, 164, 176, 188
 - definition 224
 - description 73
- THAP (measurement) 242
- Thickness (3D Render setting) 211, 213
- thumbnail images
 - printing 158, 171, 183, 196
- thumbnails
 - manipulating 53
 - printing 139
- TI (Thermal Index)
 - adjusting limit 72, 99
 - CW Doppler 105
 - definition 224
- TIB 224
- TIC 224
- time average max. See TAMX.
- time average mean. See TAM.
- time, changing 252
- timer
 - contrast imaging and 82
 - using 82

- TIS 224
- tissue harmonic imaging
 - advantages 78
 - description 78
 - limitations 78
 - using 78
- training before using equipment 89
- transducer button
 - disabled 247
- transverse imaging plane 29
- trapezoidal view 224
- triplex, definition 224
- triplex. See combination mode.
- True Echo Harmonics. See tissue harmonic imaging.
- Tru-Focus 73

U

- USB
 - ejecting storage device 60
 - storage device, exporting to 283, 285
- user-defined keys, setting up 247
- user-defined measurements. See measurements, user-defined.
- username, restrictions 257

V

- vascular calculations
 - correct placement of markers 113
- vascular imaging
 - bodymarks 133
 - capturing clips 138
 - capturing frozen images 138
 - cine review 137
 - copying or archiving images and clips 138
 - labels 133
 - measurement abbreviations 142
 - measurements and calculations 134–136
 - presets 129
 - printing from thumbnail images 139
 - printing images displayed on the monitor 139
 - reports 136–137
 - saving a new preset 139
 - Vascular Pro Package 129–145
 - VFI 131
- Vector Flow Imaging. See VFI.
- Version Information window 258
- VF (measurement) 243
- VFI
 - about 92
 - angle-independent imaging 92
 - assisted volume flow rate estimation 98
 - Color Map
 - as color flow indicator 93
 - illustration 93
 - Color Square 93
 - colors 93
 - using 94
 - velocity range affected by PRF 92
 - workflow (illustration) 99

- video
 - output modes 260
- video clips
 - capturing 52
 - format 56
 - format of copied 56
 - joining 54
 - saving 52
 - viewing 55
 - viewing and editing on system 55
 - viewing on a computer 56
- video equipment setups 36
- video format
 - affects video input 35
 - setting 251
- Video I/O Setup window 260
- Video Setup window 35, 36
- video setup, changing 35
- video window
 - closing 35
 - opening 35
- View (in Curve Setup window) 272
- View (on document browser toolbar) 54
- View Archive 54
- viewing
 - controls (for cine images and video clips) 55
 - documents stored on the system 53
 - exported documents (on external computer) 56
 - exported documents (on system) 55
 - video clips 55
- VL (measurement) 243
- volume flow rate estimation, assisted (VFI) 98
- volume flow, calculating 115
- volume measurement (3D), making 210
- voxel, definition 224
- VTI AV (measurement) 243
- VTI LVOT (measurement) 243
- VTI MV (measurement) 243
- VTI PV (measurement) 243

W

- wall filter
 - CW Doppler mode 108
- wall filter, definition 224
- Workflow Tabs 17
- worklist
 - patient information from 215
 - retrieving 215
 - selecting a patient from 215

X

- X-Shine
 - icon 84

Z

- zoom, B-mode 74

 BK Medical ApS, Mileparken 34, 2730 Herlev, Denmark. T +45 4452 8100 F +45 4452 8199



powered by analogic 

BK Ultrasound
8 Centennial Drive
Peabody
MA 01960
USA
T +1 978-326-1300
bkultrasound.com

**North America
Sales & Service**
BK Ultrasound
8 Centennial Drive
Peabody
MA 01960
USA
T +1 978-326-1300
F +1 978-326-1399
bkultrasound.com

**Europe and Rest of World
Sales, Service & Design Center**
BK Ultrasound
Mileparken 34
2730 Herlev
Denmark
T +45 4452 8100
F +45 4452 8199
bkultrasound.com

**Asia
Sales & Service**
Analogic Medical Equipment
(Shanghai) Co., Ltd.
1377, Lan Dian Road
Pu Dong New District
Shanghai
China 201132
T +86 21 2089 0333
bkultrasound.com

**Canada
Design Center**
Ultrasonix Medical Corporation
130-4311 Viking Way
Richmond
BC V6V 2K9
Canada
T +1 866-437-9508
F +1 604-279-8559
bkultrasound.com